



Architecture
and the
Built environment

#17
2017



Indoor Semantic Modelling for Routing

The Two-Level Routing Approach for Indoor Navigation

Liu Liu

Indoor Semantic Modelling for Routing

The Two-Level Routing Approach for Indoor Navigation

Liu Liu

Delft University of Technology, Faculty of Architecture and the Built Environment



abe.tudelft.nl

Design: Sirene Ontwerpers, Rotterdam

Cover image: Terminal 2, Beijing International Airport (Liu Liu)

ISBN 978-94-92516-93-0

ISSN 2212-3202

© 2017 Liu Liu (liuliu2679@gmail.com)

All rights reserved. No part of the material protected by this copyright notice may be reproduced or utilized in any form or by any means, electronic or mechanical, including photocopying, recording or by any information storage and retrieval system, without written permission from the author.

Indoor Semantic Modelling for Routing

The Two-Level Routing Approach for Indoor Navigation

Proefschrift

ter verkrijging van de graad van doctor
aan de Technische Universiteit Delft,
op gezag van de Rector Magnificus prof. ir. K. C. A. M. Luyben,
voorzitter van het College voor Promoties,
in het openbaar te verdedigen op dinsdag 5 december 2017 om 12:30 uur

door

Liu LIU

Master of Science in Cartology and Geographic Information System, Beijing Normal
University, China

geboren te Kaiyang, Guizhou province, China

This dissertation has been approved by the

promotor: prof.dr.ir. P.J.M. van Oosterom
copromotor: dr.dipl.-ing. S. Zlatanova

Composition of the doctoral committee:

Rector Magnificus,	voorzitter
prof.dr.ir. P.J.M. van Oosterom,	promotor
dr.dipl.-ing. S. Zlatanova,	copromotor

Independent members

prof.dr. C. Claramunt,	Naval Academy Research Institute in France
prof.dr.ir. B. de Vries,	Eindhoven University of Technology
prof.dr. P. A. Longley,	University College London
prof.dr.ir.arch. I.S. Sevil Sariyildiz,	TU Delft, Faculty of Architecture and the Built Environment
prof.dr.ir. P.H.A.J.M. van Gelder,	TU Delft, Faculty of Technology, Policy and Management



This work was supported by the China Scholarship Council.

Dedicated to my mother
献给我的母亲

Contents

Acknowledgments [xi](#)

[1](#) Introduction [1](#)

[1.1](#) Motivation [1](#)

[1.2](#) Research objective and scope [5](#)

[1.3](#) Methodology and tools [8](#)

[1.4](#) Outline of the thesis [9](#)

[1.5](#) Overview of related papers to the chapters [11](#)

[2](#) Background [13](#)

[2.1](#) Building models [13](#)

[2.2](#) Navigation models [22](#)

[2.3](#) Routing algorithms and methods [37](#)

[2.4](#) Pedestrian wayfinding behaviours [43](#)

[2.5](#) Indoor positioning and tracking [44](#)

[2.6](#) Adopted methods in this thesis [48](#)

[2.7](#) Summary [49](#)

[3](#) Space modelling for two-level routing [51](#)

[3.1](#) Concept, definitions and terminology [51](#)

[3.2](#) Indoor navigation space model (INSM) [57](#)

3.3	Logical and geometric networks based on INSM	67
3.4	Routing options	71
3.4.1	Routing using the logical network	72
3.4.2	Routing using the geometric network	73
3.4.3	Routing using both networks	75
3.5	Summary	89
4	Routing on logical networks	91
4.1	Motivation	91
4.2	Logical network derivation	93
4.3	Routing criteria based on INSM semantics	94
4.4	Routing procedure	104
4.4.1	Weighted routing	104
4.4.2	Multi-criteria routing	107
4.5	Summary	109
5	Routing on geometric networks	111
5.1	Motivation	111
5.2	Geometric network generation	113
5.2.1	Approach to consider user size	114
5.2.2	Edge generation of geometric networks	118
5.2.3	Compute MD between obstacles and find inaccessible gaps	118
5.2.4	Group obstacles	120
5.2.5	Select obstacle groups	120
5.2.6	Create boundaries for selected groups	123
5.2.7	Compute the MD between the boundaries of the obstacle group and walls	124
5.2.8	Create a VG considering inaccessible gaps with walls	124
5.2.9	Network from edges	127
5.2.10	Geometric network for users with changing sizes	128
5.3	Summary	131
6	Realization of one-level routing	133
6.1	Software, data, and user profiles	133

6.1.1	Data Preparation	134
6.1.2	User Profile	139
6.2	Generation of an INSM for tested data	140
<hr/>		
6.2.1	General procedure	140
6.2.2	Transformation of the INSM from tested data	143
6.2.3	Estimation of the INSM complexity	149
6.3	Routing	150
<hr/>		
6.3.1	Logical network	150
6.3.2	Geometric network	156
6.4	Analysis of the tests	162
<hr/>		
6.5	Summary	165
<hr/>		
7	Realization of two-level routing	167
<hr/>		
7.1	Factors considered for realization	167
<hr/>		
7.2	Desktop application	171
<hr/>		
7.2.1	Routing without SOIs and with one size	172
7.2.2	Routing with ordered SOIs and one size	177
7.2.3	Routing with ordered SOIs and changing sizes	180
7.3	Mobile application	185
<hr/>		
7.4	Analysis of the tests	195
<hr/>		
7.5	Summary	197
<hr/>		
8	Discussions and conclusions	199
<hr/>		
8.1	Outlook on this research	199
<hr/>		
8.2	Advantages and further opportunities of the two-level routing approach	205
<hr/>		
8.3	Directions for future research	209
<hr/>		
Bibliography 215		
<hr/>		
Appendix - Proof of three lemmas in Chapter 5 227		
<hr/>		

Summary 231

Samenvatting 235

Curriculum Vitae 239

Acknowledgments

To write the acknowledgements, the last part of my thesis, my mind went through my whole PhD journey. It has been my great pleasure to work with and learn from my incredible colleagues and friends during this journey. There are too many names to thank for their assistance with this thesis, and I would like to express my sincere gratitude to everyone, although I will mention a few of them by name.

First of all, I have the utmost gratitude for my supervisors Peter van Oosterom and Sisi Zlatanova. They have guided me throughout this journey with their vast knowledge and insights into GIS and research. As my promotor, Peter's patience and support to get me on board are sincerely greatly appreciated. I always enjoyed our discussions about the research, and you enlightened me with valuable advice and inspired me to explore diverse possibilities. The framework of this thesis was confirmed by you and many ideas were sharpened with your help. I am so grateful for everything I learned from you.

As my daily supervisor, Sisi helped me all the time with her outstanding supervision expertise, and she could always draw me back when my faith faded away and focus shifted. We had tons of discussions and wrote many publications together, which formed the essence of this thesis. Meanwhile, being a good friend, I appreciate very much that you had a lot of faith in me to become a better researcher. I thank you for everything.

Many thanks go to all the other colleagues I have worked with. It has been my great privilege and pleasure to work with all of you. I would like to thank Jantien Stoter, the head of the 3DGeoinformation group. Thank you for hosting me in this group and for all your support for my PhD project. Ken Arroyo Otori, thank you for all your time and help. I really enjoyed all the discussions with you, and your help for preparing this thesis is greatly appreciated. Elfriede Fendel, I sincerely appreciate all your enthusiastic help and support since I started my PhD journey, including the Samenvatting of this thesis. Wilko Quak, it was very pleasant to work in the same office with you. I am grateful for your help in solving my practical problems with your creative thoughts. Thanks to Hugo Ledoux, Filip Biljecki, Zhiyong Wang, Ravi Peters, and Abdoulaye Diakité for the enjoyable time when I was doing this work. Thanks to Martijn Meijers, Edward Verbree, Theo Tijssen, Marian de Vries, Tjeu Lemmens and Radan Suba for all your help. Thanks to the Chinese visiting scholars Hua Liu, Junqiao Zhao, Ying Shen, Yan Zhou, and Yeting Zhang for sharing your insights on this research. Thanks also go to Weilin Xu, Haoxiang Wu, and Kaixuan Zhou for the pleasant cooperation via the Geomatics program.

I had the pleasure of making a research visit to the headquarter of Bentley Systems Inc. at Exton in the US. I would like to sincerely thank Alain Lapierre who initiated and supported this interesting project. Thanks go to Mark Anderson and Mark Smith for hosting me at Exton and providing me with BIM IFC datasets and the mobile development toolsets for this thesis (Chapter 6 & Chapter 7). In particular, I appreciate the co-work with Mark Anderson who enthusiastically directed me throughout the development of the demos (Chapter 7) with Bentley products.

Sincere thanks are paid to the members of my doctoral committee. In particular, Bauke de Vries, Christophe Claramunt, Paul Longley, Sevil Sariyildiz and Pieter van Gelder, thanks for your time to read this thesis and to evaluate this work. It is my honor to invite you to join my committee.

I gratefully acknowledge the China Scholarship Council for funding this PhD project.

I would like to give my thanks to the secretaries/ Secretariat of OTB and urbanism departments for their administrative support during my stay in Delft and for my defense preparations. I also want to thank Franklin van der Hoeven and Véro Crickx for directing me how to format this thesis and for helping me to design its cover.

Sincere gratitude is sent to my close friends in the Netherlands, who have enriched my life throughout this PhD journey. Thank you, Chang Wang, Feijia Yin, Ying Li, Qi Tu, Yue Gao, and Ruijun Deng. I cherish your companion and support, and all the joyful time we have had with meals, travelling and laughter. My thanks also go to my old friends in China: Senyang Deng, Wei Chen, and Wei Shu. I sincerely appreciate your generous support over so many years.

I would like to give the biggest thanks to my beloved family as their support has greatly motivated me to complete this doctorate. Particularly I want to dedicate this book to my mother. Her strong faith in me always helped me through the tough times. No words can describe my love and thanks to her. I cannot thank my father enough for all the unconditional love and for encouraging me to pursue meaningful objectives. Also, I extend my special gratitude to my grandfather, who has lit up my road to knowledge since my childhood and continues to do so. Finally, my heartfelt gratitude goes to my big family for their continuous support: my grandmother, my aunties Ruyu, Ruling, Ruyao, my uncles Rujin, Lunqiang and Ruheng, my cousin Yang and all the other family members.

October, 2017

Liu Liu

1 Introduction

This chapter presents an introduction to this PhD research. In Section 1.1, the motivation of this research is presented by defining the research problem, presenting the scientific gap and introducing a possible solution. Section 1.2 presents the main research question of this research, defines the research objective and delimits the scope of this research. Section 1.3 introduces the methodology and tools adopted for this PhD research. Section 1.4 outlines the structure of the whole thesis, giving a short introduction to all of the coming chapters. At the end of this chapter, Section 1.5 lists the author's own publications and relates them to these chapters of this thesis.

§ 1.1 Motivation

Nowadays, there is a growing need for indoor navigation in large public buildings. According to the Environmental Protection Agency, 75% of the world's population lives in cities and nearly 90% of their time is spent indoors [Age09, Har12]. Humans perform many activities indoors related to work, shopping, leisure, dining, sport, etc. The buildings and the large variety of associated spaces such as underground passages, sky bridges, metro lines, garages, and intermediate platforms are becoming conglomerates of enclosed spaces (Figure 1.1). This complexity poses many challenges for building managers, occupants and visitors. Indoor navigation (e.g., finding paths to a certain location) and location-based services are some of the most important services indoors.

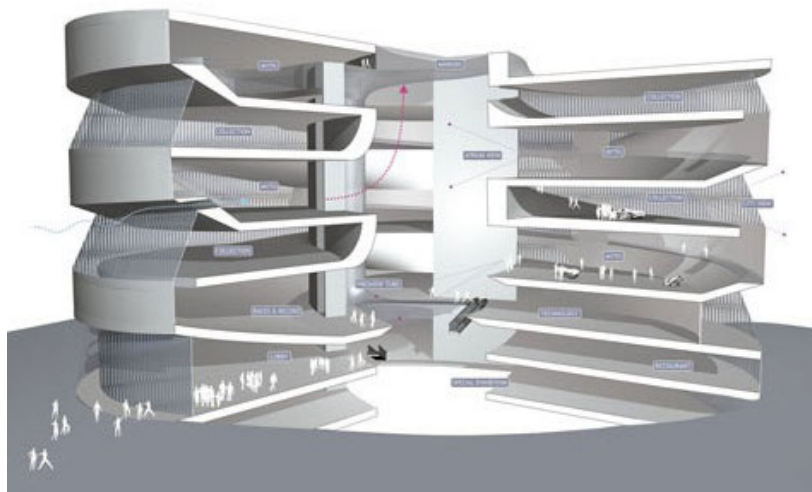

FIGURE 1.1 An example of the interior of a building (from: www.core77.com/posts/10070/winners-of-german-concrete-competition-10070)

Indoor navigation is an activity where users (e.g., robots, humans or vehicles) navigate to certain locations inside an indoor environment. Indoor navigation is a broad research field which includes five main topics: 1) indoor positioning and localization; 2) indoor modelling for navigation models; 3) algorithms for indoor path computation; 4) human spatial cognition and wayfinding and 5) indoor guidance instructions (e.g., verbal or graphic directories in an interface). Indoor positioning and localization provide user locations, navigation models represent indoor environments, indoor path-finding or routing is conducted in the navigation models to find the optimal or customized path to the target location, and guidance techniques interpret the computed path as directives that a user can follow. If guidance is not available and the user is a pedestrian, she/he can also orientate and navigate by wayfinding strategies that are based on the user's cognition of the indoor environment.

Among all these indoor topics, it is essential to acquire an appropriate navigation model representing the geometry, topology, semantics (*i.e.*, meaning of spaces) and other context information for indoor environments, and to provide appropriate routing results for different users. The other aspects of indoor navigation are closely related to the navigation model and/or routing: positioning results (*i.e.*, user locations) are visualized in the navigation model. Guidance directives rely on routing results [RZC14]. The wayfinding process needs semantic information (e.g., signage or turns) from the navigation model. A well-developed indoor navigation model should preserve enough crucial information from an indoor environment.

Indoor navigation models represent the interior of buildings in an abstract way, yet they contain sufficient information for conducting navigation tasks. Two types of models can be distinguished, that is, network (vector) and grid (raster) [ZLS⁺14]. Network models are more widely-used in pedestrian indoor navigation, while grid models are predominant in robot navigation. Topological relationships, geometric information and semantics have commonly been employed for indoor navigation on network models [Wor11]. However, the details of topology, geometry or semantics represented in the reported network models differ significantly. There are two basic groups of network models: 1) networks that preserve the geometric shapes of buildings [M]05, LOS06a, MZP05, PZ05, SLO07]. The length of paths can be measured in these networks; and 2) networks concentrating only on the connectivity of buildings [BD05, BS01, FMB00, GSC⁺05, HD04, LL08, JS02, RWS11, SSO08, YCDN07, HOP⁺08]. The first group of models are more suitable for visualising paths since the paths include accurate coordinates inside the building. However, the first group of models are not suitable for a complex and large building or building composite (*i.e.*, an aggregation of buildings), because the scale of the models can be too large for presentation on screen and computation in memory. The second group of models results in more compact representations that are very convenient for conceptual analysis. Their scale is small but building geometry is not used, thus they cannot support an accurate geometric description of the paths.

A combination of the above two types is the hybrid model, such as hierarchical graphs [LOS06b, SSO08] which can structure and represent indoor spaces/objects and their relationships in different levels according to spatial granularity (e.g., building, floor, rooms and subrooms). The hierarchical graphs include both the topology and geometry of buildings which are organized in different hierarchical levels. However, research on hierarchical graphs focuses on different hierarchical representations of buildings and only a few related routing methods are discussed. In general, paths can be com-

puted in hierarchical graphs of a building with a shortest-path algorithm. However, for a building with many levels, the routing results in different levels needing to be combined and it might be difficult to handle multiple path choices between two locations in the hierarchical graphs [SSO08].

Another important topic is to calculate an appropriate path for a given user with her/his own capabilities (*i.e.*, profile). Currently indoor routing research is concentrating on geometric-related features (distance, time cost, and the fewest turns). However, the shortest-distance path in an indoor environment is not as important as those for outdoor environments. Also, a visitor in a building may walk via a longer route through an inquiry point, and then move to the destination. In many reported studies a complete indoor navigation model is built for the buildings [Lee04, MZP05, JTY11]. These networks are designed to meet the basic requirement that indoor routes can be computed for walking users. One complete navigation network of a building is not sufficient for all users (*e.g.*, walking and movement-impaired) and their different tasks (*e.g.*, crossing a specific space or obstacle-avoidance). Navigation networks need to include the flexibility to adapt to user needs and tasks.



FIGURE 1.2 The complex interior of Schiphol Airport, Netherlands (from: www.wikiwand.com/nl/Luchthaven_Schiphol).

Building semantics can support routing to meet the needs of a user or a group of users. Compared to the outdoor paths, there are fewer options for indoor paths. Indoor paths always involve some connection spaces such as corridors, elevators, and stairs, and the number of these spaces are finite. Indoor routing needs to focus on these prominent indoor spaces reflected by their semantics. In the context of indoor navigation, the semantics of a space refers to its functionality for routing. Though semantic models of buildings such as Industry Foundation Classes (IFC) of BIM (Building Information Modeling) [IA116], and City Geographic Markup Language (CityGML) LoD4 [GKNH12] already exist, they are not specifically designed for indoor navigation. In these models the semantics of building elements (*e.g.*, rooms, doors, and floor surfaces) are abundant

yet the functionality for indoor routing is less involved. The IndoorGML [LLZ⁺14], a more recent standard of the Open Geospatial Consortium (OGC), makes a good start to structure the semantics of indoor spaces for indoor navigation. However, in this thesis I look for more specific space semantics, which allows not only the description of indoor spaces and their relationships, but can be used to specify routing criteria for different types of user.

The major challenge with indoor modelling is to represent the complex indoor environment (see Figure 1.2) for pedestrians and conduct routing according to user demands. The complex indoor environment includes irregular shapes, open spaces, 'sub' spaces (a store in a large hall), complicated obstacles (e.g., the small steel pillars in front of the escalators in Figure 1.2) and different types of passages (e.g., elevators, stairs, and escalators, large halls, long narrow corridors, and sky bridges). Typical examples are the terminals at airports, e.g., Schiphol Airport. A terminal has an irregular geometry and interior spaces separated by many columns, counters, etc.. It seems disorganized to most people unfamiliar with it. In this case, semantics are needed to classify all these spaces and objects and to reflect their functionalities for routing. In addition, indoor routing needs to consider user profile and preference [ICC12]. For example, in the same indoor environment a walking user and a wheelchair user correspond to spaces with different semantics and geometry (Figure 1.3).

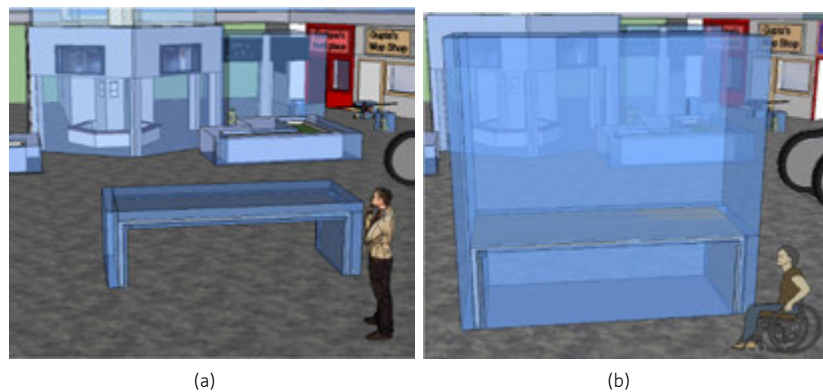

FIGURE 1.3 Different accessible spaces for distinct users. The blue volumes are considered independent functional spaces, and the others are free spaces which can be accessed without restrictions. (a) A walking user can go above or crawl under the desk; (b) a wheelchair user needs to avoid the desk.

Compared to the outdoor environment, an indoor environment of a single building as a composite is smaller in size but the complexity is increased since it represents three-dimensional (3D) buildings. Indoors spaces tend to have many obstacles (furniture, columns, podiums, etc.) that can be avoided in various ways, which increases path choices. Users face a larger number of options to go from locations A to B. In such a case, indoor paths are not only related to distance but also dependent on user preference and possibilities. In addition, as a complex building contains many obstacles, two users with distinct sizes need different obstacle-avoiding paths, such as for a user driving a vehicle in the airport and another traveller with luggage. Figure 1.3 presents two different users with different sizes – a walking person and another one with a wheel-

chair. They need different accessible paths. In addition, the walking person can get up on or under the desk, while the wheelchair user can only avoid the desk.

To solve this problem, it is necessary to avoid constructing the entire navigation network of a building again and again for every specific type of user. There can be considerable increment of nodes/edges of a navigation network for a different user when the complex building has plenty of rooms, openings and objects. It is not necessary to store and maintain a large-scale complete network for routing explicitly for all types of users. Furthermore, a complete navigation network [JM05] is insufficient to take into account changes of indoor obstacles and users. For example, when indoor obstacles are moved, a new accurate navigation network needs to be generated. A new user with a dissimilar size also needs a new navigation network since the accessible area varies in terms of the new size. The re-computation process to create navigation networks can be time-consuming for complex buildings. Even if the computation is fast, the navigation network still occupies unnecessary storage space. Thus, a more flexible navigation model is needed to represent complex buildings.

My solution is to create a navigation model which separates the semantics and geometry of buildings into two levels. Unlike hierarchical graphs, the new model does not create many levels according to space granularity. The semantics of buildings are used to find conceptual paths and they can be readily adjusted according to user preferences and decisions; the geometry is applied to network creation after a conceptual path is defined, and the network is suitable for users with a given size. In this way, only a part of space geometries is employed to construct the network for a whole building. In the next section, I will present my main research question and the research objective, which is related to the navigation model of the two levels.

§ 1.2 Research objective and scope

As shown in the discussion in the previous section, in complex indoor environments human users need diverse indoor routing yet a small number of buildings are equipped with a basic routing method, and thus the research question of the thesis is raised, *i.e.*, **what indoor routing approach can provide accessible paths according to human user preferences by using the semantics of indoor spaces, in addition to using building topology and geometry?**

The main research question is subdivided into several sub-questions which present the details of this research. To be able to conduct indoor routing for different buildings, the first sub-question is posed:

1. *What kind of information, data models and routing algorithms has been used and developed so far, and what are their limitations for large complex buildings?* (Chapter 2)

Building data sources (*e.g.*, a 3D digital building model as a Computer Aided Design file) provide abundant information but they are not structured for indoor routing. Building models can provide geometry, topology, semantics and other attributes of buildings which can be stored in indoor navigation models. I need to check the current available data models of building and the corresponding navigation models. In addition, I have

to investigate indoor routing algorithms to clarify their application scopes. In particular, I focus on the use of these models and algorithms for large complex buildings. Possible improvement will be discussed if these models and algorithms are not suitable for complex buildings. Thus I introduce the next sub-question:

2. *What data and navigation model is appropriate to represent the semantics, topology and geometry of indoor spaces?* (Chapter 3)

I need proper data and a navigation model for routing. In this research I investigate network-based navigation models and aim to develop the one that can be easily derived, stored and updated. The navigation model should contain sufficient building information to support routing, such as the semantics and the geometry of indoor spaces, the other building components (e.g., doors, windows, and walls), and indoor objects (e.g., furniture and pillars). The connectivity among the spaces, building components and objects also needs to be provided in a simple and efficient way because this facilitates routing in the next phase. Then this leads to the next sub-question:

3. *What kind of user-related paths can be computed with the semantics, topology and geometry of indoor spaces?* (Chapter 3)

Routing on the navigation model should meet user preferences/profiles, such as passing specific spaces/locations, using specific types of spaces in a path and avoiding obstacles to follow an accessible path for a user's size. This raises the next sub-question about the details of the routing approach:

4. *What kind of routing criteria can be built (or specified) by using the semantics of indoor spaces?* (Chapter 4)

To cater for different users, routing criteria need to be formed by incorporating them with the semantics of indoor spaces. As I aim to use the semantics of indoor spaces directly for routing, I investigate the relationships between building components and objects, and then identify their functionalities for routing. Different users may have distinct preferences on space semantics. Considering user sizes, I propose the sub-question:

5. *Which approach should be used to compute the exact geometric description of accessible paths according to the size of a user?* (Chapter 5)

In order to obtain accessible paths for a user, a routing algorithm is needed to support avoiding indoor obstacles with regard to the user's size.

6. *How are the new proposed user-related paths implemented and applied to realistic cases?* (Chapters 6 & 7)

To obtain indoor paths and verify the use of the proposed user-related paths, tests on the generation, efficiency and shapes of these paths are going to be conducted in realistic indoor environments. Different tests are conducted in both desktop and mobile development environments.

The objective of this research is to develop a flexible indoor user-oriented routing approach based on a new type of indoor navigation model. The navigation model should

reflect the semantics, topology and geometry of buildings, and routing can be used efficiently and flexibly in computing the user-related paths.

Within the scope of this research not all aspects of indoor navigation can be covered. The following topics are considered:

1. Design a data model to structure and store space semantics, topology and geometry of buildings for indoor routing.
2. Design an indoor navigation model for routing execution, representing both the connectivity and geometry of indoor spaces.
3. Design a routing approach that considers user-interested spaces/locations and avoids obstacles according to user sizes.
4. Design and develop applications to demonstrate and assess the use of the new routing approach.

The following topics are related or supportive but not addressed in this thesis:

1. Indoor positioning techniques.
2. Building data validation and repairing. The source data are used as-is.
3. Path planning on polyhedral building models or routing on 3D discrete models (*e.g.*, *voxels*).
4. Automation of space subdivision of buildings.
5. Indoor wayfinding.
6. Crowd behaviour/flow and spatial cognition.
7. Verbal and textual guidance for pedestrians.
8. Navigation for robot and flying objects (*e.g.*, drones) in buildings.
9. Simulation & controlling of indoor crowd flows.
10. Prediction of indoor environmental changes (*e.g.*, the dissemination of smoke).
11. Evacuation planning and navigation in an emergency response. I provide routing for a user or a group of users in a normal state, instead of for all people in a building in an emergency.
12. Integration of indoor and outdoor routing, such as aligning the indoor coordinate system to outdoor ones.

§ 1.3 Methodology and tools

To be able to answer these research questions, I have used a research methodology organized in a number of phases to conduct this PhD research. The methodology is presented as follows:

(1) Literature review (Chapter 2).

In Chapter 2, I first review current indoor navigation models and investigate their pros and cons and applications. I also investigate the relationships between navigation models and building models (e.g., data in the CAD, IFC and CityGML formats). Then generation methods of navigation models are compared with respect to the geometry, semantics and topology of building models. Routing algorithms and methods are reviewed to present existing criteria for indoor routing. Following that, indoor wayfinding research is briefly described to show some strategies for indoor navigation. Finally, I introduce the indoor positioning and tracking techniques currently being reported.

(2) User requirements are derived on the basis of a literature study (Chapters 2 and 3).

By comparing different indoor routing methods, I can distinguish the conditions and applicable scenarios of these routing methods. Uncovered user needs can be found and the evidence from this lays the foundation for the design of a new indoor routing approach (Chapters 2 and 3).

(3) A data model managing building semantics and a new indoor navigation model are designed (Chapter 3).

To be able to understand and follow a path, a human is inclined to grasp the semantics and relationships among spaces, instead of the geometric details of paths (e.g., distance and turns). I define and organize the necessary semantics of indoor spaces to represent different navigational functionalities for users. These semantics are the essence of the data model. The data model is designed to structure the adopted semantics of indoor spaces and objects and to support the automatic creation of the related navigation model. This navigation model contains the semantics, connectivity and geometry of indoor spaces.

(4) A routing approach conducted on the navigation model is developed (Chapters 4 and 5).

Based on the navigation model, I design a routing approach that provides paths in the two levels, in terms of the space preferences of users and user sizes. Considering users' space preferences, I investigate routing criteria to incorporate the semantics of indoor spaces. I also develop and test a method to compute obstacle-avoiding paths for users with a given size. For different applications, routing options are defined by combining routing in the two levels together.

The routing approach is designed on two levels: an abstract and a detailed level. The abstract level represents the semantics and connectivity of indoor spaces and the detailed level is related to space geometry. Routing on the two levels is combined for a

user's requests on the functional use (e.g., a path crossing as few stairs as possible) and geometric details (e.g., obstacle-avoidance) of indoor paths.

(5) *Implementation (Chapters 6 and 7).*

Implementation is applied to realistic routing cases. A prototype is developed to conduct the routing approach for different buildings, where indoor navigation models are created and the two-level routing is conducted. The source building models are converted into the proposed data model, and in the prototype the navigation models are generated automatically from the data.

Besides the desktop version of the routing approach, a test with a mobile application is presented as well. This mobile version is portable and thus more convenient to users, which also shows the feasibility of the proposed routing approach.

(6) *Analysis (Chapter 7).*

This part assesses the proposed solutions. I present the reflection on the obtained results within this research. Several routing options are realized in the prototype and their results are compared with respect to: the number of paths, path distances, and computational cost. A discussion on the results is given to analyse the suitable applications of the routing approach.

For this research I adopt diverse types of building models, and use different software and development tools, which include:

- **Building data:** Representations of floor plans and digital architecture plans, and 3D building models including *IFC* [IAI16] and *CityGML LOD4* [GKNH12].
- **Programming language:** *C++*, *Python*.
- **Integrated Development Environment (IDE):** Visual Studio v10.0 of *Microsoft Inc.* [Inc17].
- **Visualization tools:** the software *Bentley MicroStation V8i* [Sys16a], and a Python library *igraph* [ict16].
- **Mobile application tools:** *Bentley Navigator Mobile*, *Bentley MicroStation Mobile SDK* [Sys16b].

The *IFC* and *CityGML LoD4* data will be introduced in Chapter 2, which contains the topology and semantics and 3D geometry of buildings. *C++* and *Python* are two well-known object-oriented programming languages. For the routing application developed in *C++* language, I compile it in the Microsoft IDE Visual Studio v10.0. *MicroStation V8i* is used to visualize the building models, create valid geometry, run the developed routing application and visualize the routing results. The *igraph* is a network analysis package which is adopted to visualize the navigation network on an abstract level. As mentioned before, I test my solutions in a mobile application. *Bentley Navigator Mobile* is a mobile application of Bentley Systems, and *Bentley MicroStation Mobile SDK* supports me to develop indoor routing functions in *Navigator Mobile*.

§ 1.4 Outline of the thesis

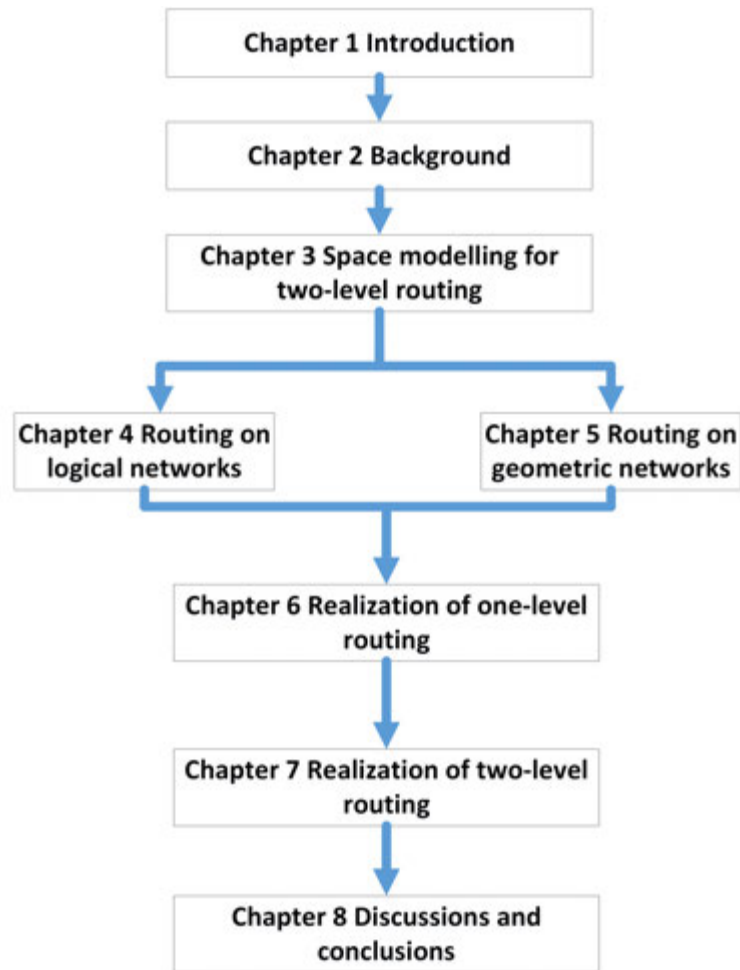

FIGURE 1.4 The Outline of this thesis.

The outline of the thesis is illustrated in Figure 1.4. Chapter 2 gives the background of this thesis, introduces the related work and elicits the requirements of a new navigation model. In this chapter I identify the differences of the current indoor modelling and routing methods, and present the needs for a new routing method.

Chapter 3 presents a new routing method named two-level routing. The two levels refer to the abstract (logical) and detailed (geometric) levels. Two independent navigation networks on the two levels are introduced for routing considering user demands. A data model is designed to support the two levels: it defines the semantics of indoor spaces according to navigational functionalities, and contains the topology and geom-

etry of indoor spaces. This data model facilitates the efficient creation of the two types of network. Different routing computations on the two networks are also presented and illustrated with examples.

Chapter 4 addresses the routing on the abstract (logical) level that uses the semantics of indoor spaces and the network topology (connectivity of spaces). This chapter presents the different criteria and the computation of routing on the abstract level.

Chapter 5 presents the routing considering a user's size on the detailed (geometric) level, and focuses on the creation of navigation networks on the detailed level.

Chapter 6 introduces data preparation for implementing the two-level routing approach, presents the generation of individual navigation networks from the adopted building data, and shows separate routing tests on the abstract and the detailed levels (*i.e.*, one-level routing).

Chapter 7 illustrates the applications of the developed tools in this research to data in the real world, which shows the results of the two-level routing. This chapter discusses the tests with various indoor data (both 2D and 3D representations). I compare the results of the two-level routing in different use cases, and discuss the improvement on the implementation of the two-level routing.

Chapter 8 provides some discussions on the whole research and concludes this thesis with some future work.

§ 1.5 Overview of related papers to the chapters

My publications that relate to chapters of this thesis are listed in Table 1.1.

Chapter	Related Publications
2	<ul style="list-style-type: none"> • S. Zlatanova, L. Liu, G. Sithole, J. Zhao and F. Mortari. Space subdivision for indoor applications, 2014. GIST Report No. 66, Delft University of Technology. • L. Liu, W. Xu, W. Penard and S. Zlatanova. Leveraging Spatial Model to Improve Indoor Tracking. The International Archives of the Photogrammetry, Remote Sensing and Spatial Information Sciences, XL-4/W5(4):75-80, 2015. • S. Zlatanova, L. Liu and G. Sithole, 2013. A Conceptual Framework of Space Subdivision for Indoor Navigation. In Proceedings of the Fifth ACM SIGSPATIAL International Workshop on Indoor Spatial Awareness, ISA '13, pp. 44-48, New York, NY, 2013. ACM. • F. Mortari, S. Zlatanova, L. Liu and E. Clementini. Improved Geometric Network Model" (IGNM): a novel approach for deriving Connectivity Graphs for Indoor Navigation, ISPRS Annals of the Photogrammetry, Remote Sensing and Spatial Information Sciences, 2(4):45, 2014.
3,7	<ul style="list-style-type: none"> • L. Liu and S. Zlatanova. A semantic data model for indoor navigation. In Proceedings of the Fourth ACM SIGSPATIAL International Workshop on Indoor Spatial Awareness, ISA '12, pages 1–8, New York, NY, USA, 2012. ACM. • L. Liu and S. Zlatanova. A two-level path-finding for indoor navigation, In: S. Zlatanova, R. Peters, A. Dilo and H. Scholten (Eds.); Intelligent systems for crisis response, LNG&C, Springer, Heidelberg, New York, Dordrecht, London, pp. 31-42, 2013.
3	<ul style="list-style-type: none"> • L. Liu and S. Zlatanova. Towards a 3D network model for indoor navigation, In: Zlatanova, Ledoux, Fendel & Rumor (Eds.), Urban and Regional Data Management, UDMS Annual 2011, CRCpress/Taylor and Francis Group, Boca Raton, London, pp. 79-92, 2012.
4,7	<ul style="list-style-type: none"> • L. Liu and S. Zlatanova. Generating Navigation Models from Existing Building Data. The International Archives of the Photogrammetry, Remote Sensing and Spatial Information Sciences, XL-4/W4(4):19-25, 2013.
5,7	<ul style="list-style-type: none"> • L. Liu and S. Zlatanova. A 'door-to-door' path-finding approach for indoor navigation. In Proceedings of GeoInformation For Disaster Management Conference 2011, pages 3–8, 2011. • L. Liu and S. Zlatanova. An approach for indoor path computation among obstacles that consider user dimension, ISPRS International Journal of Geo-Information, 4(4) pp. 2821-2841, 2015.

TABLE 1.1 My publications and the related chapters of this thesis.

2 Background

Chapter 1 presented the motivation, research question, and methodology of this PhD research. This chapter gives an overview of the essential components of an indoor navigation system and the work related to this PhD research. They are building models and related navigation models, routing algorithms and approaches and research on behaviour modes of humans for routing as described in literature. In addition, indoor positioning techniques are introduced.

Firstly Section 2.1 presents the representative data models of buildings, and Section 2.2 presents existing indoor navigation models including *indoor space subdivision*, *dual graphs*, *network-based models* and *grid-based models*. Section 2.3 introduces path computation algorithms and a number of routing approaches regarding navigation models. Then Section 2.4 briefly introduces human wayfinding behaviours which reveals the factors for humans to search for a path. Section 2.5 introduces indoor positioning techniques. Section 2.6 presents the building models, navigation networks, and routing methods that were used for this research. Finally, Section 2.7 summarizes this chapter by responding to the first research sub-question (see Chapter 1). This chapter is related to the following author's own publications: [ZLS13, MZLC14, ZLS⁺14, LXPZ15].

§ 2.1 Building models

The internal structure of buildings is always described by geometrical models (such as *Computer Aided Design (CAD)* models) and 3D GIS data models [Lee01]. For instance, CAD models contain the pure geometry of buildings in 2D or 3D forms (e.g., lines, polygons, and solids). *CityGML* is an *Open Geospatial Consortium (OGC)* standard for semantic 3D city models, as a common information model for the representation of 3D urban objects [GKNH12]. *CityGML* can represent urban terrain and 3D objects in five *levels of detail (LOD)*. *CityGML LOD4*, which specifies architectural models (interior of buildings), is used for representation of indoor environments (e.g., rooms, stairs and furniture). *CityGML LOD4* can provide semantically rich, object-based building models. Kolbe et al. [KGP05] apply *CityGML* to various disaster management applications and demonstrate how the connectivity among rooms for pedestrian access can be extracted using the shared openings (doors) between rooms.

Another group of digital building models is *Building Information Models (BIM)* which are developed for covering all the stages of the building lifecycle (from design to maintenance). *Industry Foundation Classes (IFC)* is an industry standard of *BIM* [IAI16, NSK09, IZ09], which stores both geometric and semantic information. Based on the abundant 3D geometric and semantic information (thickness, material, direction of opening, etc.) of BIMs, it is possible to automatically derive the required navigation models from

BIMs [DL08]. These two types of models (*CityGML* and *BIM*) will be extensively mentioned in this thesis.

Semantics is pivotal for indoor pedestrian navigation. The semantics of spaces reveals their meaning and functions of different building components. For example, a corridor is suitable for a user to transfer from one office to another. In the latest version v2.0.0 of the *CityGML LOD4* (see Figure 2.1), classes containing space semantics support indoor navigation include *Room*, *FloorSurface*, *GroundSurface*, *Door*, *BuildingFurniture*, *IntBuildingInstallation*, and *InteriorWallSurface* [GKNH12] (see Figure 2.1). These classes can be used to derive a navigation network of a building. Classes of *Room*, *FloorSurface* and *GroundSurface* (Figure 2.1) refer to the navigable spaces/surfaces in the building. Classes of *Room*, *InteriorWallSurface* and *Door* (see Figure 2.1) can be used to infer the connections among space (*i.e.*, instances of *Room*). For example, an *InteriorWallSurface* instance may contain a *Door* instance, and the *Room* instance bounded by this *InteriorWallSurface* links to the *Door* instance. In this manner, all the *Room* instances linked via this *Door* are connected. Classes *BuildingFurniture* and *IntBuildingInstallation* (see Figure 2.1) represent indoor static obstacles since an indoor route needs to avoid them. Different vertical passages (*e.g.*, *Stair*, *Elevator* and *Escalator*) of a building are specified by pre-defined codes for *IntBuildingInstallation* in *CityGML*.

The hierarchy of the *CityGML LOD 4* semantics are organized in its schema (see Figure 2.2). Firstly, *Room* elements can be found with the building's property *interiorRoom*; secondly, the *InteriorWallSurface* elements can be found via the *boundedBy* property of a *Room* element; thirdly, the opening property of an *InteriorWallSurface* element contains one or more *Opening* elements (*i.e.*, *Door* and *Window*). In addition, the other two properties *interiorFurniture* and *roomInstallation* of the element *Room* indicate the related *BuildingFurniture* and *IntBuildingInstallation* elements of the room, respectively.

CityGML is a uniform data model for city objects including buildings, and it is the ideal model for visualizing computed paths [VDMF09]. *CityGML* provides geometric and semantic information for indoor navigation, and specific classes which can be used for both navigational and visualization purposes. But it lacks navigation network (graph) models for the stored building data (both geometry and semantics).

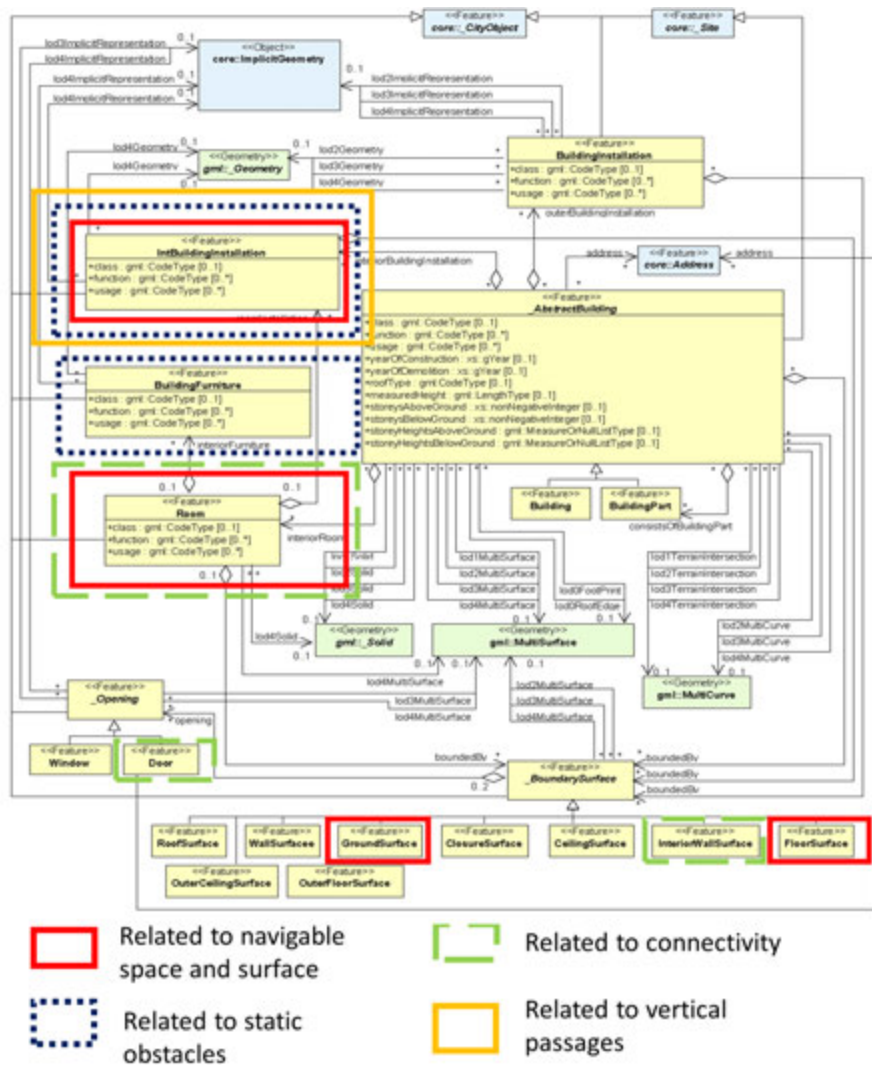

FIGURE 2.1 UML diagram of the building model of CityGML. Names of elements without prefix are defined within the *CityGML Building module (LOD4)* (from [GKNH12]). The red rectangle refers to classes regarding navigable space and surfaces. The green dashed rectangle indicates a connection among spaces (Room, Door, and InteriorWallSurface). The blue dashed rectangle refers to static obstacles (BuildingFurniture and IntBuildingInstallation). The yellow rectangle represents vertical passages.

```

<bldg:Building>
  <bldg:interiorRoom>
    <bldg:Room>
      <bldg:boundedBy>
        <bldg:InteriorWallSurface>
          <bldg:opening>
            <bldg:Door/>
          </bldg:opening>
          <bldg:opening>
            <bldg:Window/>
          </bldg:opening>
          ...
        </bldg:InteriorWallSurface>
      </bldg:boundedBy>
      <bldg:interiorFurniture>
        <bldg:BuildingFurniture/>
      </bldg:interiorFurniture>
      <bldg:roomInstallation>
        <bldg:IntBuildingInstallation/>
      </bldg:roomInstallation>
      ...
    </bldg:Room>
  </bldg:interiorRoom>
</bldg:Building>

```

FIGURE 2.2 The embedded structure with indents of a CityGML document (from [LZ13a]).

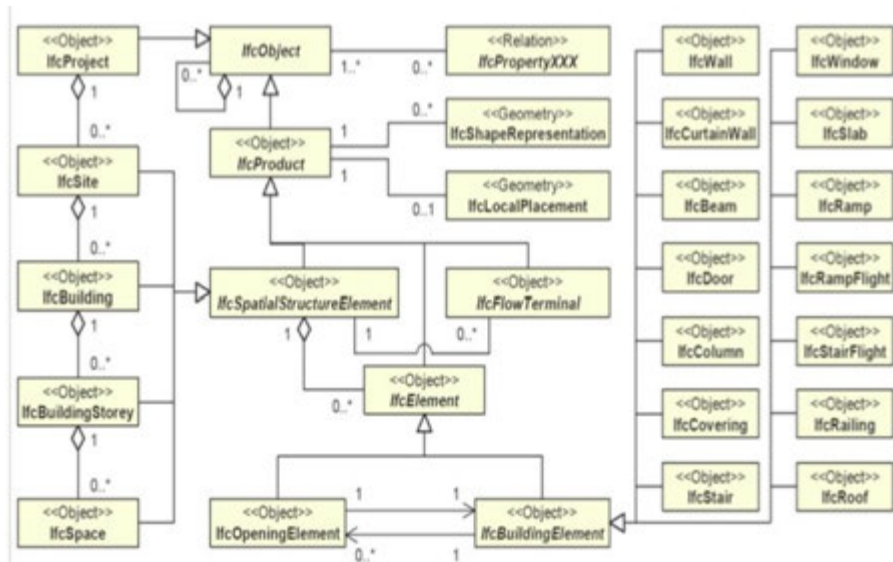

FIGURE 2.3 Subset of IFC classes for topographic spaces (from [BNZK13]).

IFC contains abundant semantics of buildings which can be utilized for indoor navigation (see Figure 2.3). The IFC includes several hundred entity classes in an entity-relationship model [IAI16, Wik16], but only a small part of classes are directly relevant for indoor navigation. Taking the version of *IFC2x Edition 3*, these essential entity classes include *IfcSpace*, *IfcWindow*, *IfcDoor*, *IfcStair*, *IfcTransportElement*, *IfcFurnishingElement*, corresponding to indoor space, window, door and stair, elevator/escalator and furniture/objects, respectively. In particular, *IfcTransportElement* covers elevators, escalators, moving walkways, etc. Moreover, classes such as *IfcRelSpaceBoundary* and *IfcRelContainedInSpatialStructure* describing relationships are important for indoor navigation. As *IfcRelSpaceBoundary* describes the bounded relation between *IfcDoor/IfcWindow* and *IfcSpace*, thus the connections between doors and indoor spaces can be derived from the *IfcRelSpaceBoundary* classes. In addition, *IfcRelContainedInSpatialStructure* provides a relationship that an indoor object is contained in an indoor space or a building floor, i.e., an *IfcSpace* instance containing multiple *IfcFurnishingElement* instances which can be obstacles to pedestrians. However, the *IFC* model lacks content of indoor navigation networks, as well as path planning information. Network primitives (nodes and edges) need to be extracted from instances of *IFC* classes, when the *IFC* model is applied for indoor navigation.

The semantics of the above two data models have a lot of overlap but they are not completely the same. They provide the 3D building information models in a comprehensive view of the geometric, cartographic and semantic aspects. Commonly many terms in the two different standards point to the same or similar semantics. For instance, there may be several different names for the same type of space in functionality (e.g., corridors, passages and entrance halls). But the *IFC* and the *CityGML LoD4*, which are the data models for buildings, do not include indoor navigation networks. For indoor navigation, it is necessary to develop a specific data model unifying space semantics which correlate to navigation networks, which can facilitate the generation of navigation networks from building models.

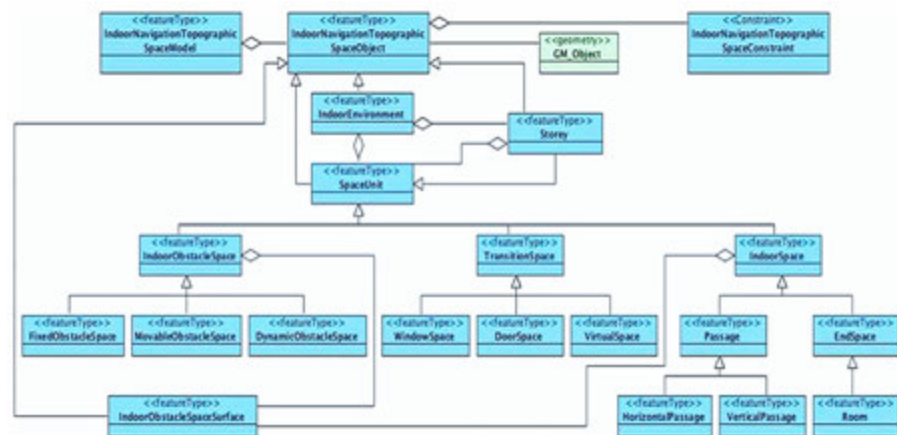

FIGURE 2.4 Indoor Navigation model (from [BNZK13]).

Brown et al. [BNZK13] provide a concise description on indoor spaces according to their navigational functionalities (see Figure 2.4). The model clearly distinguishes be-

tween obstacles and spaces for navigation (e.g., transition and indoor spaces). Lee *et al.* [LLZ⁺14] present a generalized data model named *IndoorGML* regarding indoor spatial information (which is now already an OGC standard), specifically for navigation purposes. The *IndoorGML* data model includes two parts: the *Core* module including basic concepts on space, and the *Indoor Navigation* module (see Figure 2.5) which focuses on the semantics of spaces for indoor navigation. The class *NavigableSpace* of *IndoorGML* denotes generic navigable spaces. One of its subclasses *GeneralSpace* refers to common independent rooms, and another subclass *TransferSpace* has three other subclasses: *ConnectionSpace*, *AnchorSpace*, and *TransitionSpace*. *ConnectionSpace* mainly refers to the thick doors regarded as 3D spaces. Specifically, *AnchorSpace* depicts the connections between indoor and outdoor worlds, such as an entrance door of a building. Either a stair or corridor, or even a part of them, can be classified as *TransitionSpace*. The *Indoor Navigation* module also provides classes to specify paths, such as *Route*. I have also developed another semantic data model *indoor navigation space model (INSM)* with more specific functionalities of spaces for indoor routing [LZ12], which will be elaborated in Chapter 3.

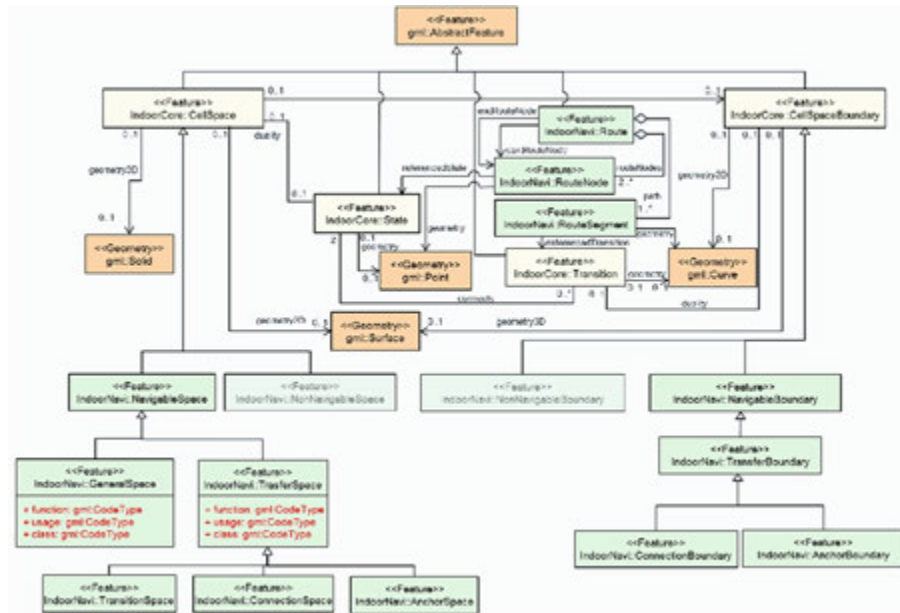

FIGURE 2.5 The UML diagram of the Navigation module (in green) in IndoorGML (from [LLZ⁺14]). Yellow is for the core module of IndoorGML, and orange for OGC Geography Markup Language Encoding Standard (GML) [PCD⁺07].

Compared to CityGML and IFC, the IndoorGML is mainly about the description and representation of indoor navigation networks and spaces. IndoorGML aims to define the indoor space instead of building features such as in CityGML [RKL15]. The space classes of IndoorGML are relevant to elements of navigation networks. These networks are designed according to Poincaré Duality [Whi32, Mun84a]. Duality is a one-to-one mapping relationship between two related geometries. A planar graph [Whi32] consisting of nodes and edges can be formed on the basis of a 3D room (*i.e.*, a 3D closed manifold): one node for each room and one edge for every two rooms with adjacent

faces. In this case, a node is the dual of a room and this graph is called a *dual graph*. The vector space regarding all these original geometry (rooms) is named *primal space*, while the vector space containing all these duals is named *dual space*. Although the *IndoorGML* provides a schema framework for indoor navigation based on space connectivity, it does not introduce the transformation method for the network from building data.

Different navigation networks can be integrated into the *multilayered space-event model (MLSEM)* [BNK09]. As the 'event' represents dynamic information such as leaving or entering a room, here only the 'space' part of *MLSEM* is discussed. The *MLSEM* provides a multilayer representation for different spatial models, such as the topographic space for 3D buildings and the sensor space for sensor range partition. Buildings can be subdivided not only with respect to the topographic /geometric / construction properties of buildings, but also regarding the spaces defined by security reasons, Wi-Fi coverage, motion-impaired users, emergency cases, etc. (Figure 2.6b). In the *MLSEM* model, each space layer is mapped into the primal and the dual spaces according to *Poincaré Duality*. For example, a 3D room in the primal space corresponds to a node (OD) in the dual space. On another dimension, each space layer is also divided into the topology and geometry spaces (Figure 2.6a). Various layers of the space models are connected by so-called joint state edges, which represent the space overlap of two nodes from the two space models. At any one time only one joint state edge and related nodes are active. In the dual space of topographic space layer (Figure 2.6c), navigation networks can be derived in the same way as the one reported by Lee [Lee04].

A building ontology refers to the semantics of indoor spaces, and the semantics can be applied to facilitate the generation of navigation models of a building for pedestrians (usually graph structures). An ontology describes a set of definitions of classes and properties and their relationships for a particular domain [NM01, BCC06]. For instance, it is relatively straightforward to obtain connectivity relations between indoor subspaces with knowledge of doors and rooms. Furthermore, navigation-related semantics of indoors (e.g., navigable space, obstacle, etc.) facilitates routing, and user-related semantics (mobility, transport preferences, etc.) are more perceivable to users. Based on American Disability Act standards, Dudas *et al.* [DGK09a] develop an ontology and an algorithm named *ONALIN*, which considers the needs of different groups and individuals on their feasible routes. Karimi and Ghafourian [KG10] propose ontologies about path segments and points of interest which aim to provide safe passage for the visually impaired. Tsetsos *et al.* [TAKH06] give an ontology of building elements and paths, and a comprehensive list of user modelling as a user ontology. Goetz and Zipf (2011) present another ontology named 3D Building Ontology (3DBO) (see Figure 2.7) about building elements and navigable parts [GZ11a]. But these semantics are either too general from a navigational point of view [TAKH06], or too specific separating similar spaces such as a room and a corridor [GZ11a].

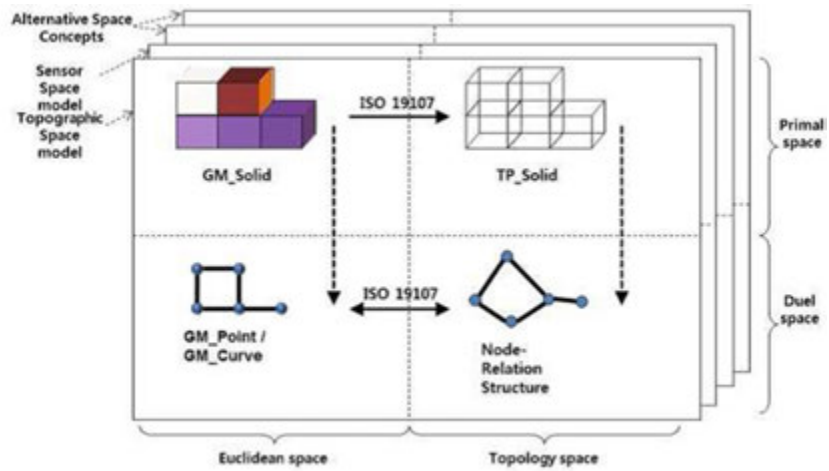

(a)

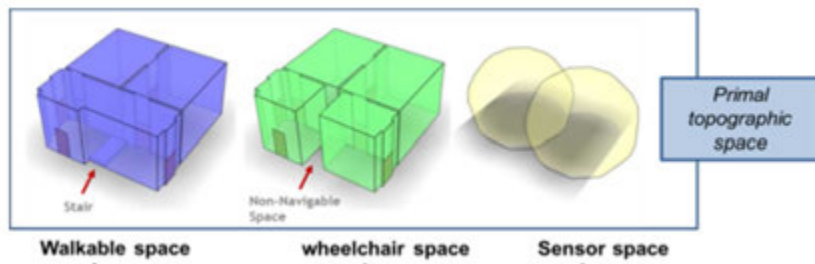

(b)

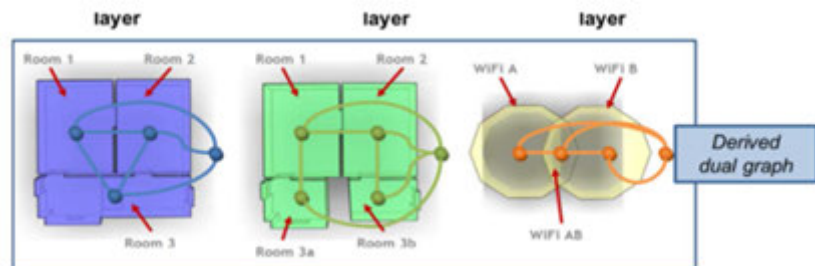

(c)

FIGURE 2.6 MLSEM layers represented in different space forms. **(a)** Different forms of building representations; **(b)** The building representation in primal topographic space; **(c)** The derived dual graphs (*i.e.*, networks) (from [BNK09]).

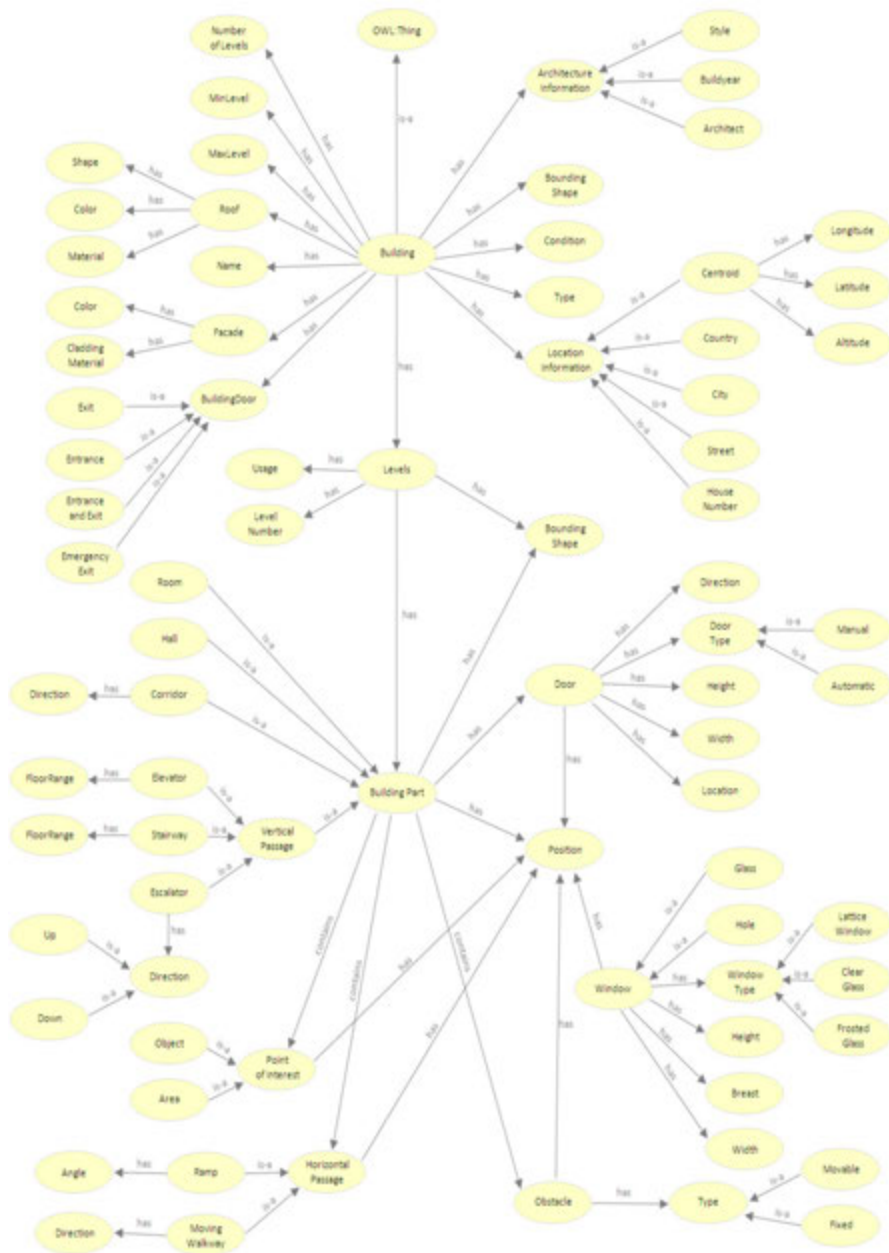

FIGURE 2.7 The 3D Building Ontology (from [GZ11a]). It mainly describes the inside of buildings, and also presents navigable parts such as classes VerticalPassage and HorizontalPassage.

To obtain the semantics of spaces, a building needs to comply with a certain subdivision [ZLS13]. Different subdivision results consist of distinct types of space on functionalities. For instance, a lobby can be separated into more spaces, or it can be seen as one. In some cases, source building models have provided a subdivision result. Various semantic data models have been developed with the focus of users or easy extraction of navigation networks [DGK09b, KG10, Wor11, YW11].

A subdivision concentrates on the minimal space unit with close space size to be identified. Generally, two types of subdivision can be distinguished – structural and functional subdivisions [RWS11]. A structural subdivision follows the physical structure of a building (e.g., an office bounded by walls), while the functional subdivision defines spaces according to their functionalities, and provides comfort, safety and security to ensure the necessary boundaries of separated indoor spaces [KZ14]. For instance, Richter *et al.* [RWS11] separate rooms into offices, laboratories, computer rooms, facilities (e.g., toilets), passages (e.g., corridors), etc. The functional subdivision also aims for different users [TAK⁺05, RWS11]. Kruminaite and Zlatanova [KZ14] extend the functional subdivision method to consider functional subspaces (which may be inside of a larger space) of indoor objects, depending on their characteristics such as attractiveness, necessity, limited capacity, closeness to central areas, and possession of transition area.

The subdivided spaces refer to the nodes of the topological model (graphs) of a building. But for one set of nodes, various relationships can be established. For example, a connectivity graph provides space relationships that indicates an agent can pass from one subspace to another. An adjacency graph denotes all the neighbours of a specific space. Furthermore, not all spaces might be considered (or accessible) in a specific navigation case, which results in another type of topological model, *i.e.*, the accessibility graph [Wor11]. Thus, a topological model heavily depends on the subdivision result and the relationships between these spaces (*i.e.*, edges in the graph) [NSK09]. These topological models (*i.e.*, a kind of navigation models) will be further discussed in the next section.

Navigation models can be derived from building models for pedestrians. A navigation model is the computational foundation for routing, such as navigation networks or grid models. Indoor routing can be conducted on the navigation models. Previous work shows that 2D geometry, such as floor plans, is frequently used to generate adjacency and connectivity networks [PZ05, LOS06b, SLO07, MZLC14]. There are approaches regarding 3D building models as well but they are either based on 2D floor plans [JTY11], specific application [SZVO11], or at quite a conceptual level [BNK09, BNZK13]. In these approaches 3D building models are mainly used for visualization, after the path is computed based on 2D floor plans. The next section will introduce different types of navigation model.

§ 2.2 Navigation models

Indoor navigation models represent the interior of buildings in a simplified way, but they contain sufficient information for conducting navigation tasks. Two types of model can be distinguished, that is, network (vector) and grid (raster). Network models are

more widely used in pedestrian indoor navigation, while grid models are predominant in robot navigation. Commonly topological relationships, geometric information and semantics have been employed for indoor navigation on network models [Wor11]. The details of topology, geometry or semantics represented in the reported network models differ significantly. There are two big groups of network models, *i.e.*, models that preserve the geometry of the building [JM05, LOS06a, MZP05, PZ05, SLO07] and those omitting geometry [BD05, BS01, FMB00, GSC⁺05, HD04, LLO8, JS02, RWS11, SSO08, YCDN07, HOP⁺08]. The first group of models are more suitable for visualizing paths since the paths include accurate geometric shapes inside the building. The second group of models results in more compact representations that are very convenient for conceptual analysis.

In 2D building models, navigation models are mainly derived from two types of subdivision: subdivision according to a certain criterion and regular subdivision. Some of these models adopt semantics (such as notations of doors, windows, walls) to refine navigation paths. The subdivision according to a criterion can generate navigable spaces from floor plans by following the building structure, or can break down 2D floor plans into cells according to certain criteria (*e.g.*, convexity, visibility, max cell size, functionality, *etc.*). The regular subdivision results in regular grids such as rectangular, hexagon, octagon, *etc.*, which represent the spaces at a certain granularity [ICC12].

In 3D building models, related research [Lee04, MZP05, JTY11, HEZ12, CWSC14] mostly places a 3D representation by the layered model of 2D floor plans. The regular subdivision results in navigation networks based on the building structure, while the subdivision according to a certain criterion can generate either networks or regular grids according to a specific partitioning (*e.g.*, constrained *Delaunay triangulation* algorithm or visibility criterion). To simplify the complexity of 3D geometry, semantics are also being largely incorporated into these navigation models. In the following parts navigation networks and grids are introduced for both 2D and 3D building models. In both 2D and 3D building models, subdivision can result in different hierarchies of indoor space, *i.e.*, multiple levels of indoor space such as *floor*, *section*, *room*, and *subroom*. Some examples of such space hierarchy will be presented later in this section.

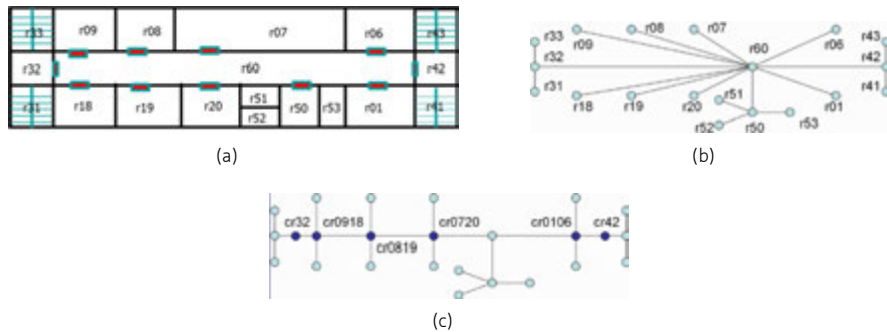

FIGURE 2.8 A 2D network created on the basis of Poincare Duality, Media Axis Transform and information about doors. (a) Floor plan; (b) The metric network based on connectivity of spaces; and (c) The metric network considering door locations (from [MZP05]). The nodes cr32, cr0918, cr0819, cr0720, cr0106, cr42 represent precise geometric locations in the space related to node r60 (in subfigure (b)).

2D Navigation Network. Usually the network is based on *Dual Graph*, *Media Axis Transformation (MAT)*/*centerline/shape skeleton* algorithms, *Visibility Graph (VG)* or combinations of them [ICC12]. Figure 2.8 illustrates the most common approach utilizing a dual graph, MAT and information about doors (*i.e.*, straight MAT) [MZP05, CL09]. The dual graph [Whi32, Mun84b] results in the room-to-room type of paths since each room is represented by a node. If the MAT method cannot result in a sufficiently detailed path, new nodes are introduced to provide semantics, *i.e.*, building elements such as doors and windows (Figure 2.8c). Mortari *et al.* [MZLC14] propose another network model based on *Constrained Delaunay Triangulation* to improve the MAT-style methods. This network is generated with consideration of space between indoor obstacles. Such a network would be re-computed if indoor obstacles change. Besides, many studies have discussed topological and semantic representations of indoor spaces for both robots and pedestrians [BS01, GSC⁺05, JS02, RWS11].

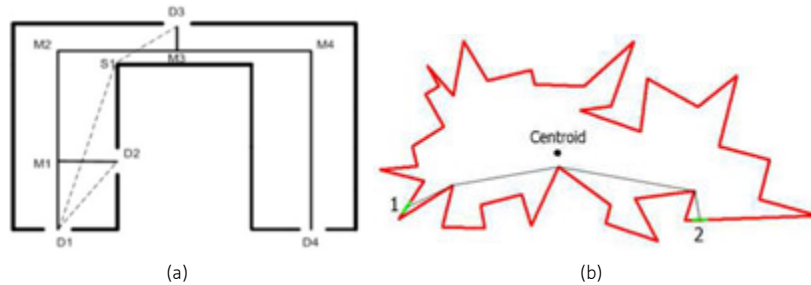

FIGURE 2.9 The VG-based method. (a) The comparison of VG paths and the MAT; and (b) The shortest paths computed on a visibility graph (from [LZ11a]).

Another approach to create a navigation network is the VG method [Lat91, dBCvKO08]. Some research of indoor pedestrian navigation straightforwardly employs VG algorithms or slightly modifies them for certain purposes [HBK⁺10, KBH12, SGS12]. In contrast to MAT, VG does not follow the shape of the building spaces (Figure 2.9), but provides a direct path among points of interest, *i.e.*, the door-to-door type of paths [LZ11a]. Commonly space subdivision is needed in this case since VG is constructed inside each room. VG networks also need re-computation if there are changes of indoor obstacles (*e.g.*, with extended size).

Lorenz *et al.* (2006) proposes a modification of the MAT- and VG-based approaches. In this case doors are abstracted as nodes (*i.e.*, they are considered spaces, see Figure 2.10), and a room can be represented by only one node (representing a small space) or several ones (representing a large space, such as nodes cr32, cr0918, cr0819, cr0720, cr0106, cr42 in Figure 2.8c). This approach allows for the room-door-room type of paths.

Some other methods consider the subdivision of a 2D floor into cells according to certain criteria. Several typical criteria to subdivide indoor spaces are found in the literature. To help robots pass through bottlenecks and avoid collision between moving objects, Lamarche and Donikian [LDO4] apply a series of algorithms such as the *constrained Delaunay triangulation* algorithm and *Convex Cell* optimization (*i.e.*, to merge the resulting triangles into convex cells which contain the minimum number of cells) to subdivide 2D floors (Figure 2.11). The original floor is subdivided into smaller convex

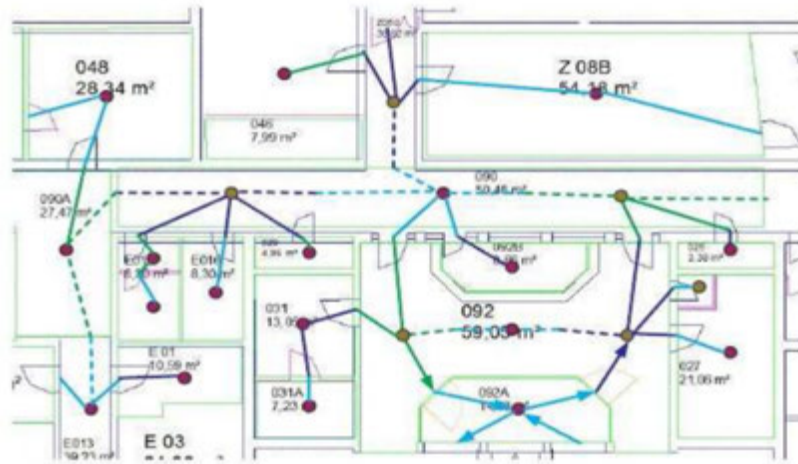

FIGURE 2.10 The navigation network regarding both rooms and doors as spaces (from [LOS06a]).

regions, which can be used to derive a navigation network. Stoffel *et al.* [SLO07] propose a method that partitions a floor plan into convex regions according to the visibility criterion (see Figure 2.12). In such a convex region, openings are mutually visible. This is a typical example of the door-to-door (or portal-to-portal) navigation.

According to Xu *et al.* [XWZ16], the MAT method cannot ideally deal with large complex spaces, and VG-based methods need to use obstacle vertices as nodes for navigation networks. They propose a subdivision method for 2D floor plans based on *Delaunay Triangulation* which can generate a network inside a room and passes through gaps of obstacles. However, the time complexity of this method would need to be further clarified if it was to be applied to large complex buildings.

Wallgrün [Wal04] develops a method for robot navigation based on the generalized Voronoi diagram. This approach generates navigation networks relying on the pure geometry (including obstacles) (see Figure 2.13). In this case notations of doors are of no importance. In addition, some nodes at corners of the network are removed (Figure 2.13c).

3D Navigation Network. Researchers [Lee01, Lee04, MJ05, PZ05, BG10] generally classify the 3D geometric models of buildings into the geometric network and the topological network that represents the connections among spaces in buildings. The topological network is used to compute conceptual paths and the geometric network is used for accurate routing and visualization. In order to conduct reliable and fast computation, many researchers adopt the graph model to represent connectivity relationships of indoor spaces [Lee04, MJ05, LDO4]. In the geometric network, detailed paths can be computed more accurately for pedestrians.

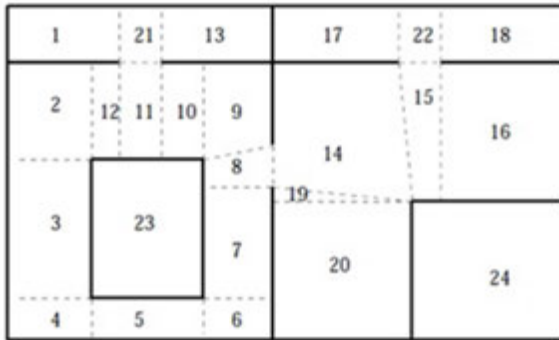

FIGURE 2.11 The subdivision with Delaunay triangulation and Convex Cell optimization (from [LD04]).

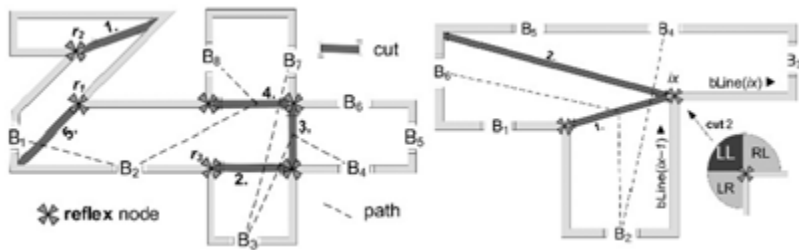

FIGURE 2.12 Visibility partitioning result (from [SLO07]).

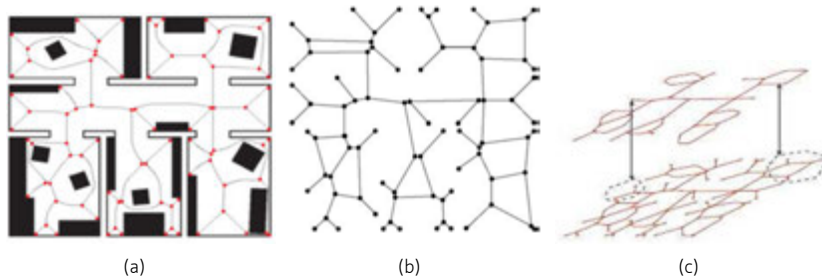

FIGURE 2.13 The navigation network derived from the Voronoi diagram. (a) The original plan; (b) The navigation network regarding spaces on a floor; and (c) The simplified network in the higher hierarchical level, i.e., floors (from [Wal04]).

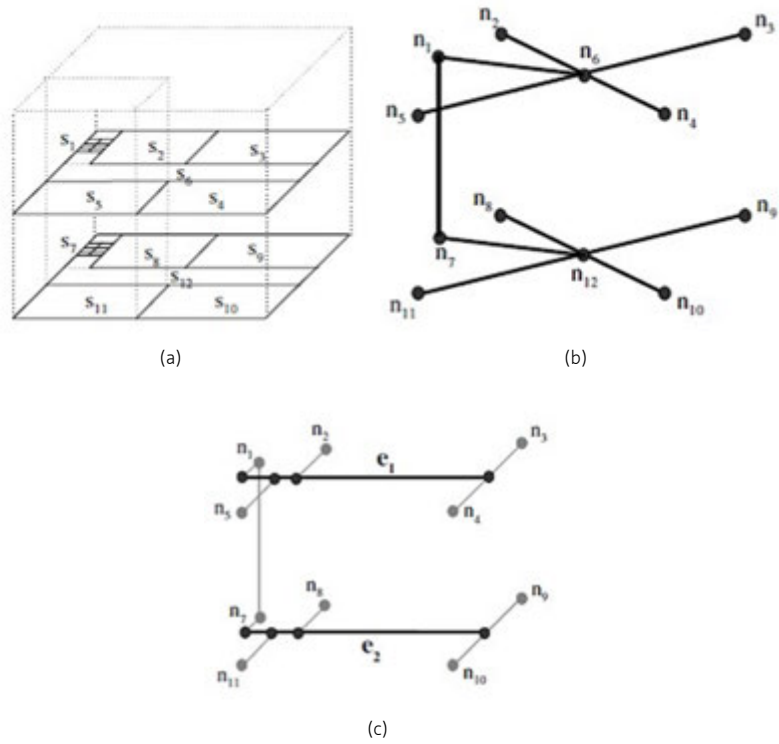

FIGURE 2.14 An example of the navigation network in 3D. (a) Floor plans representing indoor spaces; (b) The topological network (connectivity graph) of these indoor spaces; and (c) The geometric network. The long spaces S6 and S12 are transformed to more refined nodes, and edges are precise paths between two nodes (from [Lee04]).

Lee [Lee04] designs a *Node-Relation structure (NRS)* (i.e., *Dual Graph*, see Figure 2.14b) to represent the connectivity of buildings [Lee04]. *Room-Door* relations are converted in the primal space to *Node-Edge* relations in the dual space [Whi32, Mun84a]. In order to represent indoor environments more accurately, Lee (2004) extends the *NRS* to the *Geometric Network Model (GNM)*, which introduces metrics [Lee04]. Lee (2004) also adopts a skeleton-abstraction algorithm to construct a 3D *GNM* (Figure 2.14c), i.e., *Straight-Medial Axis Transformation (S-MAT)* modelling method [EE99, CL09], which can abstract linear features from simple polygons (such as corridors).

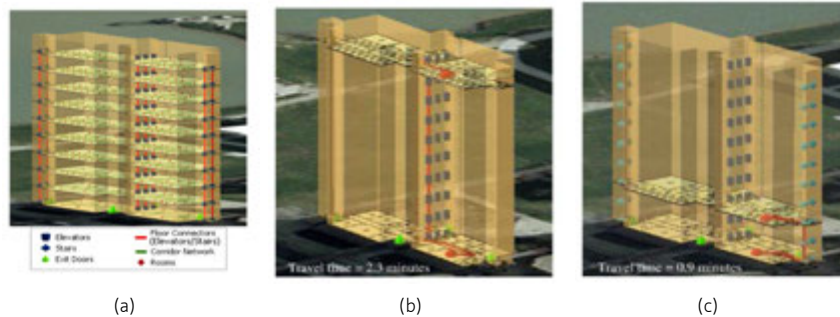

FIGURE 2.15 2D floor plans embedded in 3D space and linked to the outdoor network (from [JTY11]).

In some cases (especially within regular buildings), 2D floor plans are embedded into 3D spaces of a building. Thill *et al.* [JTY11] adopt this approach and demonstrate it can be applied in the combination with outdoor networks (Figure 2.15). Such approaches manage to accommodate many properties specific to indoor spaces, such as ingresses and egresses, vertical movements in stairs and elevators, movements on escalators, and segments that are not accessible due to impaired motion ability. The resulting visualization and rendering can be achieved in both 2D and 3D views and can enhance the guidance associated with individual movements through indoor spaces. Navigation on the individual 2D floor plans can be performed according to any of the 2D approaches mentioned in the previous section. However, such 3D cases need information about walls and ceilings or more detailed locations in vertical connecting spaces such as stairs and elevators.

Another group of approaches consider walkable connected surfaces for navigation [Sli06, SR08, Sch10, SZVO11], without explicit networks. In this case, topologically-connected and navigable spaces (surfaces) are embedded in 3D space. Slingsby and Raper [SR08] construct a navigable space model from 2D plans with additional information on heights and surface constraints (Figure 2.16). This approach ensures the connectivity relationships among spaces (represented by these surfaces).

Another type of network can be built with volumes and surfaces: the dual of a volume is a node and the dual of a surface is an edge (Figure 2.17a). Boguslawski *et al.* [BGL11] follow a data structure similar to the *NRS* structure [Lee04] (Figure 2.17c). There is little elaboration on the semantics but it is assumed that the approach would work with any space subdivision and space definition, which can easily generate topological networks.

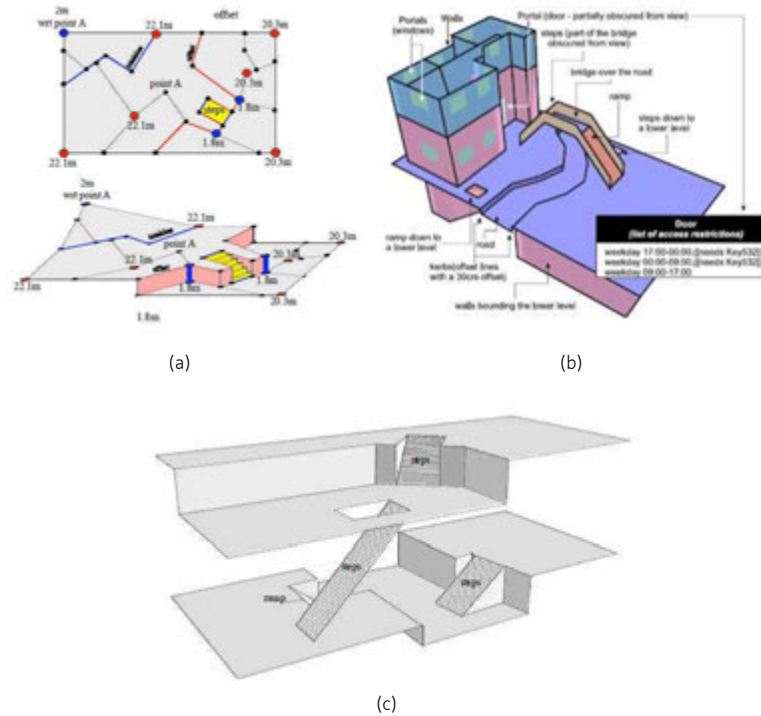

FIGURE 2.16 The space accessible to a walking individual. (a) Constraints; (b) Over-spanning objects; and (c) Indoor navigable surfaces (from [SR08]).

3D semantic models of buildings also support the generation of navigation networks, such as *CityGML LOD4* and *IFC*. The inherent subdivisions of the semantic models can be used to derive the connectivity via openings (e.g., doors and windows). Theoretically *CityGML LOD4* [GKNH12] offers a straightforward approach as the rooms are described by bounding surfaces that link to openings (Figure 2.18). Information about obstacles can be derived from the objects defined as *IntBuildingInstallation*. However, other obstacles such as moving objects cannot be mapped from *CityGML*. Liu and Zlatanova [LZ13a] have presented the generation of topological networks from a *CityGML LOD4* model of a building (see Figure 2.19).

There is similar research on creating networks based on *IFC* models [LH08, TC16]. To derive a network from an *IFC* model, Teo and Cho [TC16] propose a network called a *multi-purpose geometric network model (MGNM)* (including indoor routing, see Figure 2.20). The MGNM is built in the following steps: 1) extract building information from *IFC*, 2) create the MGNM (i.e., a geometric network) on the extracted information, and 3) create topological relationships of the MGNM in a Geodatabase.

In a full 3D model, Diakit  and Zlatanova [DZ16] propose a method to extract the navigable space considering indoor furniture. These semantic spaces are created for indoor routing, such as a network of connected 3D spaces (volumes). With such spaces, one can know the exact extent where a subject (a pedestrian, robot or drone) can navigate.

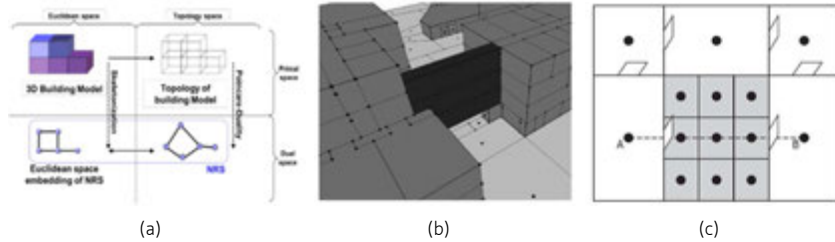

FIGURE 2.17 Networks based on volumes. (a) The NRS structure (from [BNK09]; (b) Topological model; and (c) The derived path (from [BGL11]).

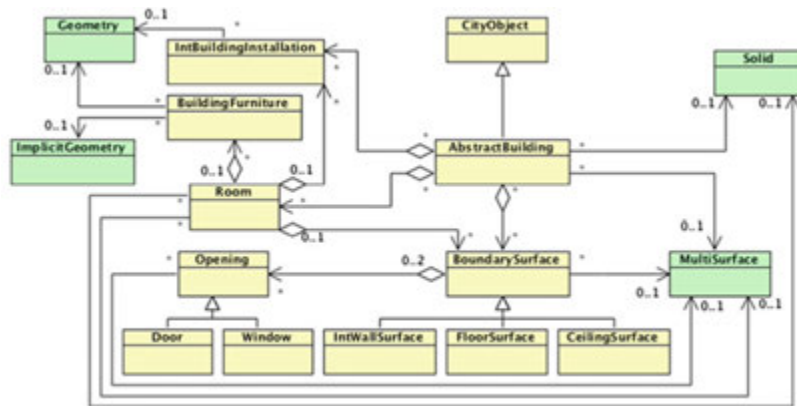

FIGURE 2.18 The simplified schema of CityGML LOD4 which is also a semantic model (from [BNZK13]). It can provide a part of indoor semantics such as a room and an opening.

Boguslawski *et al.* [BMZF16] propose a construction method about *Variable Density Network (VDN)* to determine egress paths in dangerous environments, which includes a full 3D topological model. They consider VDN can increase the accuracy of prediction for egress path planning.

There is a special combination of navigation networks – hierarchical graphs. Hierarchical graphs [BD05, BS01, HD04, JS02, JM05, LOS06a, SSO08, YCDN07] contain topological and/or geometric networks of spaces (*e.g.*, *floors, zones, rooms, and sub-spaces*). Figure 2.21 illustrates such a model. The two floors include fifteen rooms and two subspaces in the room r14 (see Figure 2.21a). On the floor level, the topological network of the floors is represented by two nodes f1 and f2 (see Figure 2.21b); on the room level, the two floor nodes are extended into two topological networks of rooms. On the sub-room level, the room node of r14 is extended into a topological network of two subspace nodes (sr1 and sr2). In these models, distinct topological networks can be derived based on different space decompositions of a building.

The hierarchical graphs aim to represent a complex environment with a spatial representation of multiple graphs. Normally navigation networks are of a small size com-

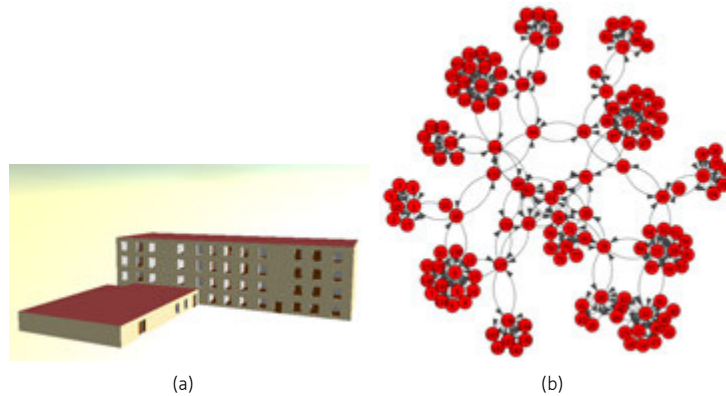

FIGURE 2.19 Generation of the connectivity graph from the CityGML LOD4 model. (a) The testing building; and (b) The generated connectivity graph (from [LZ13a]).

pared to road networks, which indicates the topological network of buildings is generally small. Thus, a user does not need a hierarchical graph in a simple building when routing can be easily achieved.

2D Grids. Another large group of approaches is based on regular grids such as rectangles, hexagons, octagons, etc. [ICC12]. The discrete 2D grids overlap the 2D plan (Figure 2.22). Each grid cell obtains semantics according to the underlying 2D objects (rooms or doors). This approach allows for a precise localization in a large open space, and it is often used for applications which require tracking and correction of positions [GCZ⁺11] or integration with continual phenomena such as smoke or fire. The grid-based approaches originate from robot navigation. Grids allow incremental movement (and speed control), which facilitates driving, collision detection and manoeuvring of robots. The size of the grid is of critical importance. If the grid size is too coarse, important indoor information may be lost. Alternatively, too fine a grid may increase the computational load.

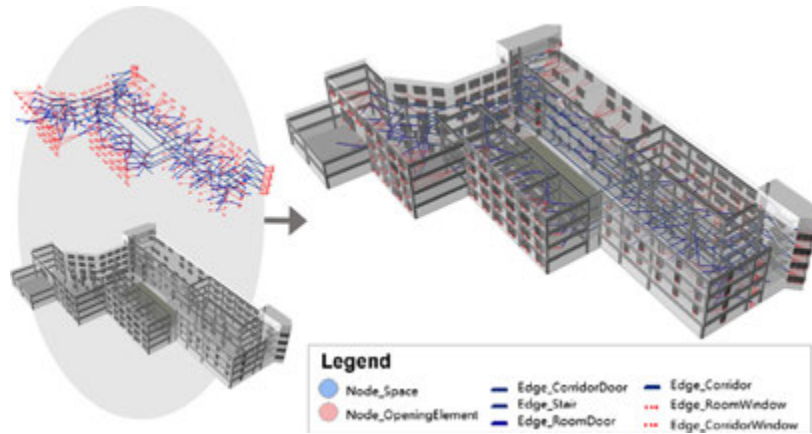

FIGURE 2.20 The network created from a BIM model (from [TC16]).

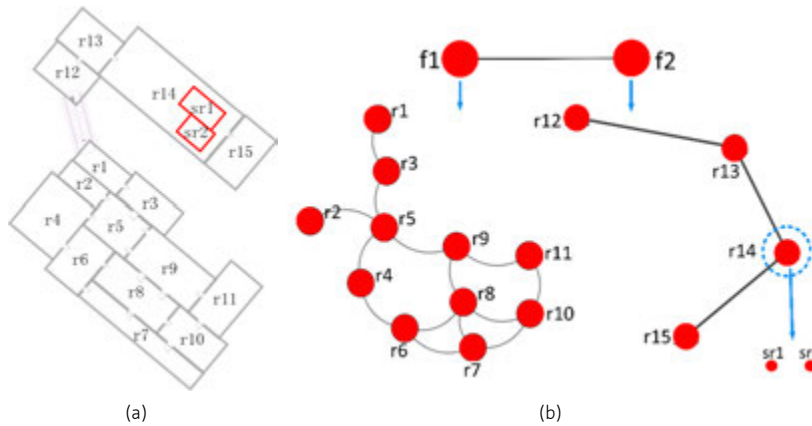

FIGURE 2.21 The hierarchy graphs for two floors. (a) Two floors of fifteen rooms with two subspaces; and (b) The hierarchy of floors, rooms, and subspaces. The hierarchy includes 2 floor nodes, 15 room nodes, and 2 subspace nodes.



FIGURE 2.22 The subdivision of square and hexagon grids (from [ICC12]).

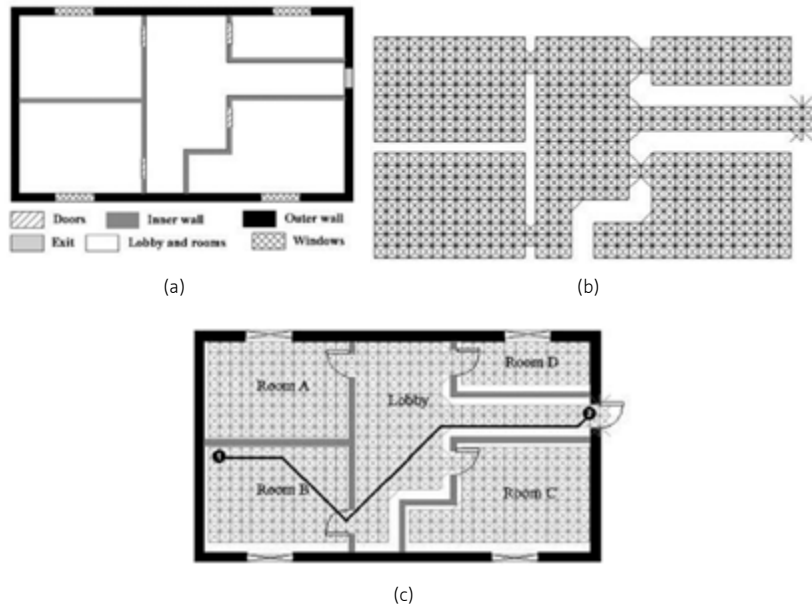

FIGURE 2.23 An example of a 2D grid model. (a) Semantic annotations of a floor; (b) Generated grids; and (c) The shortest path on the network derived from the grids (from [LCR10]).

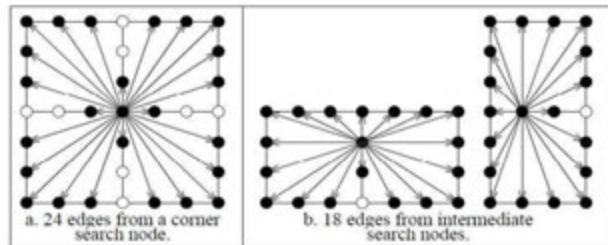

FIGURE 2.24 24 and 18 search directions of nodes on the grid model (from [VBWVHO93]).

A network can be generated from the grids, and the navigation network of the grid model can be implicit and avoid storage of many grid cells with $O(n^2)$ space complexity. For example, the nodes represent the centres of the grid cells and the edges of a certain node represent connections between the node and its neighbours [LCR10] (Figure 2.23). Moreover, the movement of a grid can be planned in multiple numbers of direction. Bemmelen *et al.* [VBWVHVO93] propose an approach to make more search directions for moving through a raster cell (grid, see Figure 2.24). The overview of the 2D grid approaches does not aim to be complete but contains only the principle tendencies. As grid-based approaches mainly rely on geometric subdivision (*i.e.*, a continual space into grids), the related path finding on the grid models does not heavily rely on the topological and functional meaning of indoor spaces.

3D grids (voxels). Basically, 3D grid approaches are an extension of 2D grid ones. A 3D grid-based (voxel) network can represent the 3D structure of indoor space. For example, intermediate levels in a floor (*e.g.*, ramps and platforms in the air) can be represented. Yuan and Schneider [YS11] propose a model called a LEGO graph based on 3D voxels (see Figure 2.25). This method computes the accessible parts of indoor environments and considers the constraints of the width and height of users (such as drones).

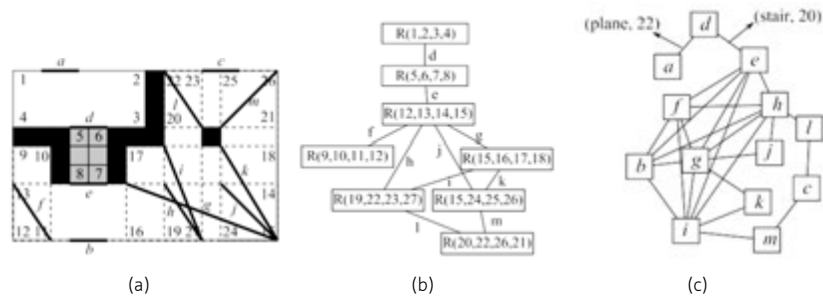

FIGURE 2.25 The LEGO graph. (a) Subdivided blocks of a floor; (b) The graph representing the connectivity of blocks; and (c) The resulting LEGO graph (from [YS11]).

Bandi and Thalmann [BT98] discretize the whole scenario space into 3D voxels and compute an obstacle-free feasible route with consideration of surmountable and insurmountable obstacles and the ‘hole area’ (*i.e.*, insurmountable obstacles may be encompassed by a closure of reachable grids) in buildings (Figure 2.26). This method can easily deal with height information and can generate routes of various heights (Figure 2.26b).

3D voxel models (see Figure 2.27) for navigation are also applied to game simulations [Hel13, GBK14]. Game simulations have many similarities with robot and human navigation. Many agents (game characters) navigate similar to humans. For example, they can jump over the low obstacles or even get through the holes in walls if allowed. A typical study in this field is to project all the obstacles of the animated scene to a 2D bitmap to accelerate the process of forming a path plan [K]98]. Andújar *et al.* [AVF04] present an algorithm for camera path computation based on voxelisation. This algorithm determines the free-space structure of the scene and provides various measures to find out the best path for visiting (Figure 2.28).

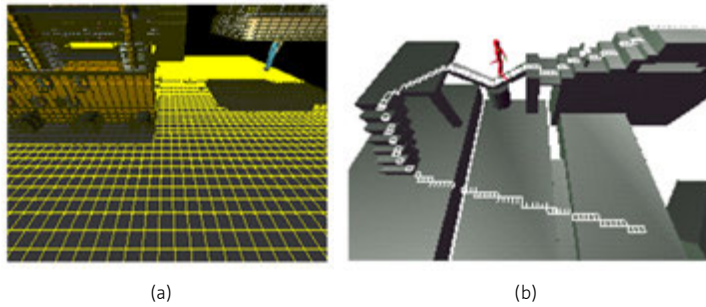

FIGURE 2.26 Reachable voxels and the generated path (from [BT98]).

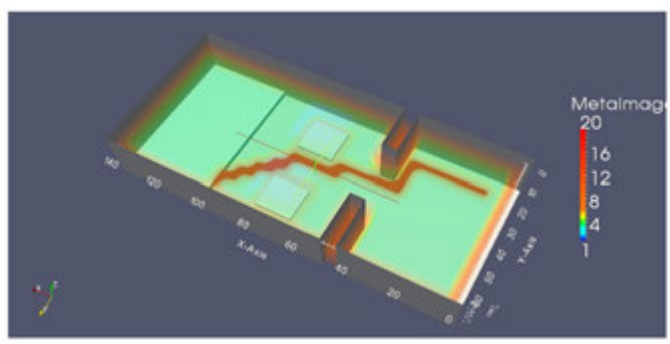

FIGURE 2.27 An example of a voxel model (from [Zha13]).

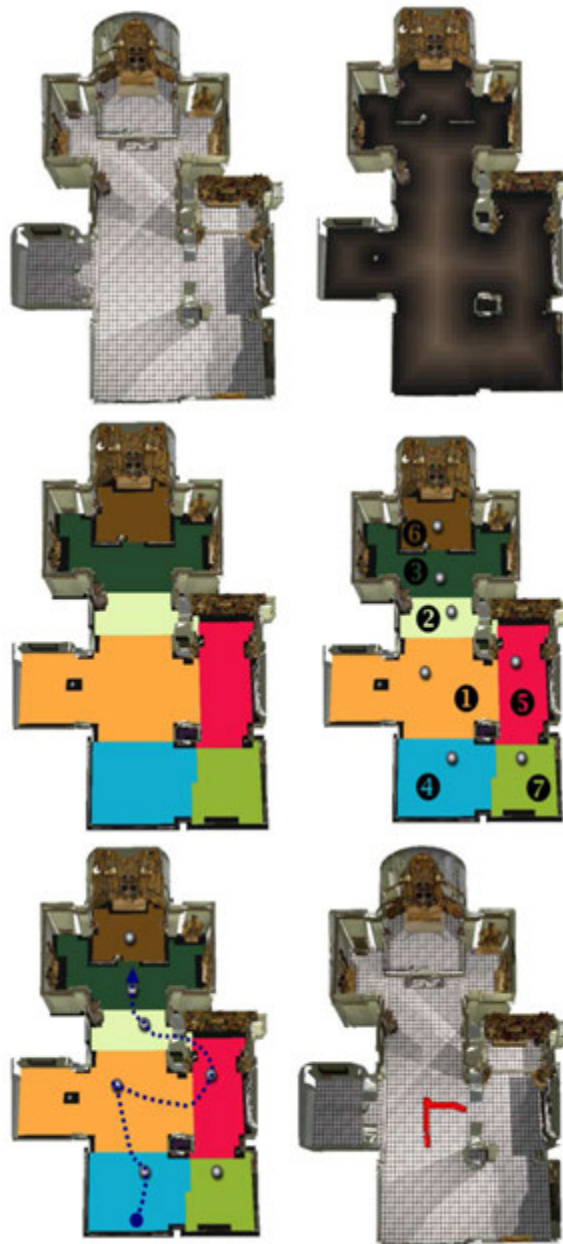

FIGURE 2.28 Top view of the original model; high-level path through the five most interesting cells (the dashed lines) and the computed low-level path (from [AVF04]).

Generally, 3D regular grids (voxels) have a great potential for indoor navigation. The voxel model can readily indicate the membership (e.g., corridors, rooms and stairways) of each voxel and incorporate various semantics of these voxels. 3D voxels can also take into consideration height constraints and allow path computation at certain heights (i.e., flying), under or around objects by applying the shortest path algorithms such as A-star [HNR68] (see Figure 2.27).

Fichtner [Fic16] proposes a workflow for semantic classification based on unstructured 3D indoor points by using an Octree structure. With some preconditions (e.g., wall perpendicular to floor), indoor semantics such as floor, storey, stair, and wall can be identified. The walkable surface consists of floors and stairs. This work presents the potential of the semantic-enriched data for indoor pathfinding based on walkable voxels. But the process of identifying stairs needs to be improved for other applications.

Regular grid methods with an appropriate resolution are slightly superior to network methods on locating agents, because they are mostly developed for the more complex robot navigation. Network methods tend to be used for human navigation and as such, they provide less detailed routing, assuming that human intelligence will compensate for inaccuracies. Human-based network routing considers semantics much more in comparison to grid-based routing. The network always contains the functional or thematic meaning of indoor spaces, while a grid model considers space semantics less.

§ 2.3 Routing algorithms and methods

In this thesis, routing is referred to as the automation of searching path on a data structure (e.g., graph). Single-source path finding is the focus in this thesis, i.e., one user or a small group of users moves from a start location to one other place (or multiple places). In fact, this routing is the single-source shortest path problem. A number of algorithms has been developed to solve the problem such as Dijkstra [Dij59], Bellman-Ford [FJ56, Bel58] and A-Star (A*) [HNR68]. The Dijkstra algorithm finds the shortest paths from a source node to all the other nodes in a graph. The Bellman-Ford algorithm also solves the single-source problem when edge weights of a graph are negative. The A* algorithm adopts heuristics to speed up the search for the shortest path between a pair of nodes. They are algorithms run on a graph which is referred to as a navigation network in our context. For 2D/3D grids, these algorithms can be conducted on the graph that represents the link relationships of these grids. Some heuristic algorithms such as the D* (a dynamic A*) algorithm [Ste94, Ste95] are also developed for robot navigation in dynamic environments.

Other graph-search algorithms such as breadth-first search (BFS) [Lee61] and depth-first search (DFS) [Sed02] can also aid pathfinding in buildings, such as in hierarchical graphs. Specifically, the BFS is a special variant of A*. Bellman [Bel58] introduces a dynamic programming approach to solve the minimum travel time problem. In this problem, an optimal path (whose cost is travel time) through multiple locations linked by road should be determined. Besides, only a finite number of iterations will be required in this iterative algorithm. This method can be applied to navigation networks to compute indoor paths.

Although the above algorithm can be applied to navigation models (networks or grids) of buildings and compute paths for indoor navigation, many studies propose *ad-hoc* routing methods and routing criteria relying on specific navigation models and user needs [WMY07, LSA08, CDO08]. Different from outdoor navigation, indoor paths are relatively limited and the distinct requirements of various users are significant for indoor navigation. For example, the shortest path can be readily computed in a navigation network of a building, but it may not be the 'optimal' path according to the user (e.g., 'optimal' refers to the fastest path). As the 'optimal' definition can vary, the focus of indoor routing is to obtain different indoor paths according to given criteria.

Indoor routing for pedestrians needs a larger spectrum of paths compared to outdoor. The criteria for outdoor routing mostly are distance, travel time or number of turns [DGK09a] that are all based on metric information (e.g., length and angles). Visser [Vis09] proposes a path-finding approach which concerns changes in road environments and predicts future situations. This approach can automatically generate routes within disaster areas with consideration of the changing gas plume and temporarily closed roads. But this method is only applied in a 2D road network. Another alternative is the *Indicative Route Method (IRM)* proposed by Karamouzas *et al.* [KGO10]. It is built on the corridor map proposed by Geraerts and Overmars [GO07]. The corridor map structure offers a set of collision-free spaces. The IRM can generate routes as smooth skeletons in a corridor map. Though IRM is a convenient method for considering obstacle avoidance, currently the network of indicative route cannot be automatically created.

For indoor navigation, there are many non-metric factors influencing indoor routing (e.g., cognitive similarity to pedestrians, temperature deviation of spaces, the number of visual signs). The mostly frequently used criteria for routing are geometric [GZ13, MZP05, Whi06, YS11]. Dudas *et al.* [DGK09a] define two other types of paths: feasible and comfortable paths. The term feasible refers to accessible paths for users with special needs (e.g., mobility-impaired), while the term comfortable indicates the subset of feasible paths that is assumed to be preferable to the users. Each edge of a geometric network is assigned a weight representing the degree of comfort to a user. The degree of comfort is specified according to the user's preferences. The comfortable path is a user-specific path especially about mobility (e.g., elevators for motion-impaired users). For a set destination regardless of their order, the comfortable path is the one through these destinations with the minimum cost. Then the comfortable path can be computed by shortest-path algorithms based on the weights. In city scenarios, the least visible path [LZLF08] is proposed to search a least-cost path which stands for the least chance to be sighted. This routing criterion uses reverse viewshed at each location (*i.e.*, the visible area viewed from the other locations). The resulting least-visible path includes the minimal visibility privilege.

Another non-geometric criterion is the Least-effort [CWSC14] which minimizes the total required travel time to reach a destination. In indoor environments, time and safety are vital factors in emergencies [PZ05]. Moreover, environment, event and human factors should be considered for indoor path planning [ZB08]. For instance, crowd flow velocity changes over time on connectors (corridors and stairways) of buildings. In addition, individual parameters (e.g., physical ability) critically limit indoor path selection as well.

Li and Lee propose [DL08] the notion of semantic distance including geometric distance information and the graph structure information between two locations. It con-

nects to the number of spaces (e.g., the number of connective nodes in a path) and the number of doors in between two spaces. In a connectivity graph of indoor spaces with edge weights of semantic distance, graph-based algorithms can be applied to path computation. Another useful criterion for a topological network is centrality. For example, in a connectivity graph or adjacency graph of a building the centrality of a node measures the relative importance of the node regarding accessibility [S.05]. The centrality can be computed in different ways such as the degree, betweenness and closeness. The degree of nodes indicates the number of nodes connecting to a node. The closeness measures how 'close' a node is to the others. The betweenness of a node is the ratio of the number of shortest paths via the node and that of all the shortest paths (among all the possible pairs of the start and target nodes).

Routing with multiple criteria is seldom discussed in indoor routing. This type of routing is a kind of multi-objective optimization [CDO08, Deb14, JT10], which aims to solve the optimization problem regarding a number of (even contradictory) objectives. Some related work is found in evacuation routing research, which simulates the behaviour of dense crowds. Multi-objective optimization approaches have been considered as suitable ways to address the realistic requirements of evacuation planning [AS09, SS09, LLHY08]. In the hierarchical directed network of a stadium, Fang *et al.* [FZL⁺11] propose a multi-objective optimization approach to solve the evacuation routing problem. Three criteria are considered in this approach, *i.e.*, minimal evacuation time, minimum of total evacuation distance and minimal cumulative congestion degrees. This approach is based on the *ant colony optimization (ACO)* algorithm [BM04, Blu05] to simulate the evacuation process.

Lyardet *et al.* [LSA08] compute indoor paths for users according to multiple factors in addition to distance, such as temperature, crowdedness, and turns. This path computation employs a weighted-sum method [Deb14] to compute a unique path from a set of feasible paths. As a typical example in outdoor networks, Nadi and Delavar [ND11] propose a general approach for multi-criteria and personalized path planning (regarding user preferences), which results in multiple alternative routes from different decision strategies.

Another easily conducted method, *Lexicographical Goal Programming*, is developed in the research of multi-objective optimization [CDO08, Deb14, JT10]. When there are several different criteria to be selected, preferences have to be set up (the importance of the criteria). The method has been applied to routing with priority of criteria. A user has to specify the order of the routing criteria. Paths are computed according to the first criterion (*i.e.*, the most important one). Then the computed paths form a new smaller network and new paths can be derived on the new network in light of the second important criterion, and so on. The computation stops when all the criteria have been checked or only one path is found.

Apart from the above routing approaches regarding different criteria, there are other indoor routing methods relying on specific navigation models or structures. Wu *et al.* [WMY07] propose a path-planning algorithm within indoor environments for visually impaired. This method consists of three parts: cell decomposition, cactus tree-based path planning for the building, floor and area, and the A* based path. The cactus tree (See Figure 2.29) is a non-linear data structure of relationships among indoor elements (the building, floor regions, and locations) for path searching [WMY07]. Rela-

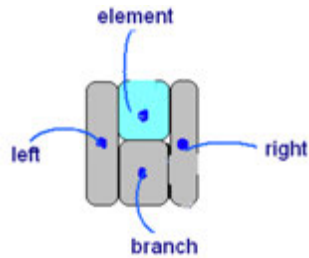

FIGURE 2.29 Illustration of Cactus Tree structure (from [WMY07]).

tionships in this tree are hierarchical, and a cactus tree-based search can be used in path planning in a floor, area or between regions.

Moreover, another type of solution has been proposed as the triangulation-based method [BS01, CDO08, VTCG11]. Based on a particular triangulation strategy, indoor environments are represented by different triangular areas. Thus a certain MAT network can be derived and used for indoor routing.

Rodenberg *et al.* [RVZ16] present an indoor routing case based on an Octree structure derived from point clouds of a building. This research generates an Octree of 3D voxels for a building from point clouds, and then forms a navigation graph by considering the connectivity for each node to all its possible neighbours (*e.g.*, other faces, edges and vertices). Finally, the A* algorithm is applied to the derived network for pathfinding.

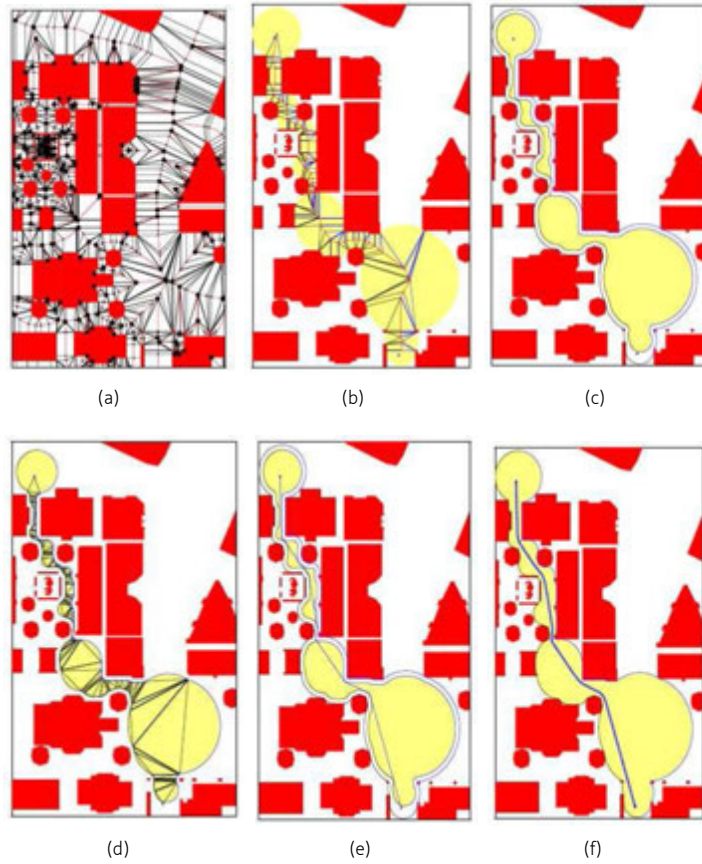

FIGURE 2.30 The path computed by the corridor map algorithm. (a) Corridor map with the points of the closest distance; (b) The closest points along a route and corresponding clearance; (c) Shrunk corridor; (d) Triangulation; (e) Funnel shortest path algorithm; and (f) The smoothed path (from [R.10]).

Geraerts [R.10] presents an approach for path computation by delineating the space, navigating through the spaces in a given tolerance and then smoothing the path (Figure 2.30). The result is equivalent to the VG-based path computation, but avoids the complexity of creating VGs for the entire indoor environment. This approach exclusively relies on geometric algorithms, especially for avoiding obstacles. Though this method is applied to outdoor routing, it can be transplanted into the indoors when 2D floor plans are available and the status of all doors is considered as ‘open’.

Xiong *et al.* [XZZ⁺15] propose a new type of indoor routing method to make use of semantics. This method voxelizes indoor scenarios, derives regions with navigable area and semantics, traces boundary of regions, and then generates navigation meshes. Routing on these meshes provides a path between two semantic locations. In the resulting paths, some of them are close to walls and stairs, which needs to be improved.

There are also routing computations regarding hierarchical graphs/networks of buildings. Hu and Lee [HD04] propose a hierarchical symbolic model, exit hierarchy and location hierarchy based on a tree model, where the shortest path algorithm can be applied for routing. A number of studies [JM05, TAK⁺05, YCDN07, GSC⁺05, HOP⁺08, SSO08, RWS11] propose hierarchical networks of buildings where routing can be performed by using common path-finding algorithms (*e.g.*, the shortest path algorithms).

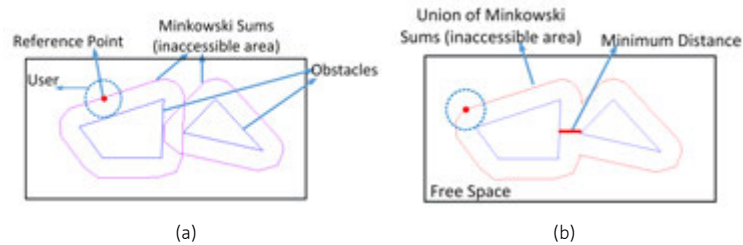

FIGURE 2.31 Minkowski sums of obstacles to a user and the minimum distance between obstacles. (a) Minkowski sum of obstacles for a user approximated as a circle; and (b) Union of the Minkowski sum of obstacles and the minimum distance.

Another important issue for indoor pedestrian navigation is obstacle avoidance. Previous research has considered indoor obstacles in the navigation network [GZ11a, LYJS09, SR09, MZLC14] and obstacle-avoiding path finding [HBK⁺10, KBH12, SGS12]. However, the work has not discussed the influence of user sizes. In contrast, robot motion planning has always taken into consideration the dimensions of robots. The Minkowski sum method [dBCvKO08, Coe12] has been commonly applied to identify inaccessible areas for a robot. Figure 2.31 presents an example where a robot is approximated with a circle. A Minkowski sum of an obstacle expands the obstacle according to the robot’s size (the circle’s radius in Figure 2.31a), while simultaneously the robot shrinks to a ‘reference’ point (see Figure 2.31a). The Minkowski sum of obstacles represents the inaccessible area for the robot. If the Minkowski sums of different obstacles intersect, then they will be merged into one to form a closed area that is inaccessible for the robot (see Figure 2.31b). The other space is regarded as free space for the robot, and the robot can follow paths in it.

There are a few studies discussing the dimensions of pedestrians for indoor routing. Generally, navigation models for pedestrians do not refer to accessible indoor areas of users [CWSC14, HBK⁺10, KBH12, Lee04, LOS06b, MZP05, SGS12, SR09, JTY11]. They implicitly regard a user as a point or approximate the user with a very small size. Yuan and Schneider [YS11] model indoor space with different types of cubes and merge the cubes to reflect the accessibility for users. However, the study did not provide a detailed or practical solution to computing paths for users with different dimensions.

Mostly, the size of users has been taken into account to investigate the accessibility of indoor environments for wheelchair users [HLLK02, KS15, OMP09, Pru10]. Han *et al.* [HLLK02] employ the Minkowski sum method to outline the accessible areas for wheelchair users. Otmani *et al.* [OMP09] and Pruski [Pru10] pinpoint the accessible areas for wheelchair users with respect to the orientation of the user. Their approach is also based on the *Minkowski sum*. Kostic and Scheider [KS15] propose an approach for computing accessible areas on a grid model (*i.e.*, regular cells). According to the shape of the user and the wheelchair, the computed areas can support the movements aligning with the x- and y-axis and the 90-degree rotation case. All the research aims to find the bounded polygonal/grid accessible areas for wheelchair users and then to compute paths inside the areas.

§ 2.4 Pedestrian wayfinding behaviours

Indoor navigation involves both guidance (*i.e.*, instructions/indications for how to physically move in computed paths) and pathfinding (*i.e.*, to compute paths between or among different locations). The related notion 'wayfinding' is about how pedestrian themselves find their way in a cognitive process [HB15]. Navigation guidance can be reflected by path instruction, *i.e.*, detailed explanation of a computed path for pedestrian users. As addressed in Chapter 1, this research does not focus on indoor guidance. Wayfinding is about the process that a pedestrian employs to independently find her/his way with aids of indoor configuration (*e.g.*, signs). Thus, wayfinding is helpful to explore pedestrian behaviour modes and investigate path selection criteria.

Wayfinding for outdoor environments has been studied for decades. The well-known landmark-route-survey framework [SW75, TG83] indicates the spatial knowledge representation in human cognitive processes. The knowledge provides people with self-guidance to a target location in an environment: he/she can use landmarks to orient herself/himself to the destination, follow a continuous route, or complete their orientation by survey knowledge (the complete cognitive image of the environment). Thorndyke and Hayes-Roth [THR82] point out that maps provide a user with general survey knowledge rather than precise route knowledge. Maps may also interrupt the orientation of a user since the user cannot align her/his motion with the maps [LJP82, BAH593]. Therefore, many studies focus on making use of landmarks [RW02, MS07, XA]C08, HGL⁺09].

In a similar way, wayfinding also supports a user navigating inside buildings [MZV15]. Soeda *et al.* [SKO97] include vertical motions in the wayfinding process, which importantly influences the movement among different floors. Hölscher and Brösamle [HB07] show that a user unfamiliar with a building has more difficulty in performing wayfind-

ing. A complex building causes a heavy memory load even for a user acquainted with the building. In this case, direction is significant during the wayfinding [KT03, PH12]. A user sensitive to directions presents better performance than those who are not sensitive. Meanwhile the user with a better sense of direction tends to flexibly use effective strategies related to turns, directions and landmarks. However, indoor navigation (including wayfinding) is commonly developed to navigate users unfamiliar with a complex building. In addition, a sufficient navigation system should support common users, no matter whether they have a poor or keen sense of direction. For example, Stook [Sto12] develops a solution to transform indoor Wi-Fi-based positioning results to location information (e.g., Room 2.200). In this way, Stook [Sto12] forms clear descriptions about paths for users according to their profiles.

The solution of using landmarks can compensate for the disorientation of a user. People can adopt landmarks as anchors and conduct wayfinding without better survey knowledge [SK07]. Similarly, indoor wayfinding values landmarks since they reduce the memory burden of a user. Additionally, using landmarks benefits the generation of path instruction [HP10]. Thus landmarks are ideal tools for indoor wayfinding since they support effective interactions between humans and environments [RW14]. Landmarks have also been adopted to generate path instruction for guidance, such as Walk to the lower end of the stairs marked with the sign 'Neubaugasse'; then walk up the stairs [RGL⁺07]. In general, landmarks make the wayfinding more tangible to pedestrians.

The indoor wayfinding research inspires some strategies for indoor navigation. There are some heuristic methods aiming to simplify as much as possible a wayfinding process [CTG⁺06, HB07]. Hölscher *et al.* [CTG⁺06] differentiate three wayfinding strategies, *i.e.*, the central point strategy, direction strategy and floor strategy. Using the central point strategy is to find a path by trying to transit well-known locations (e.g., landmarks) of buildings. By applying the direction strategy, a user heads to the horizontal position of a destination as directly as possible and regardless of the level changes. By applying the floor strategy, a user needs firstly to find a path to the storey of a destination, then horizontally move to the destination on the storey. These strategies reflect wayfinding behaviours. Some other factors such as the colour and light of an indoor environment can also influence wayfinding performance [HYA12]. In addition, Rüetschi [Rüe07] indicates that structural information of buildings can support wayfinding, though it may not result in optimal paths. In general, all the research findings can be adopted to design and compute indoor paths imitating the wayfinding behaviours.

§ 2.5 Indoor positioning and tracking

Nowadays indoor navigation heavily relies on an accurate and stable positioning or localization technique. Unfortunately, most existing positioning techniques are still at an experimental phase [Mil06, CNPM11]. Compared to outdoor GPS tracks (recordings of positions at regular intervals), indoor positioning suffers from low accuracy, which results in a limited number of indoor tracking applications. Current types of localization systems are based on different techniques, including *Angulation (angle)*, *Lateration (distance)*, *Fingerprinting*, *Inertial* and *motion sensors*, and *Neighborhood* [CNPM11]. Here the Fingerprinting method is the focus since it is the currently popular method

for indoor pedestrian localization and some commercial applications have been developed.

To be able to localize a person or robot in a given indoor area, the indoor space has to be partitioned. Such artificial subdivision/decomposition can be based on a *regular grid* (*grid for short*), *triangulation tessellation*, *trapezoidal-based tessellation* and *Voronoi diagrams* [ICC12]. Grid is widely applied to indoor navigation and tracking. Li *et al.* [LCR10] elaborate on a grid graph model. They first overlay the building parts/ cellular units (such as a room, a wall, etc.) with grids and then generate a grid graph. The underlying cellular units provide semantic information to the corresponding grid cells. In the grid graph, each grid cell has one and only one membership of a semantic, and the topological relationships among cellular units can be represented by the edges of the grid graph.

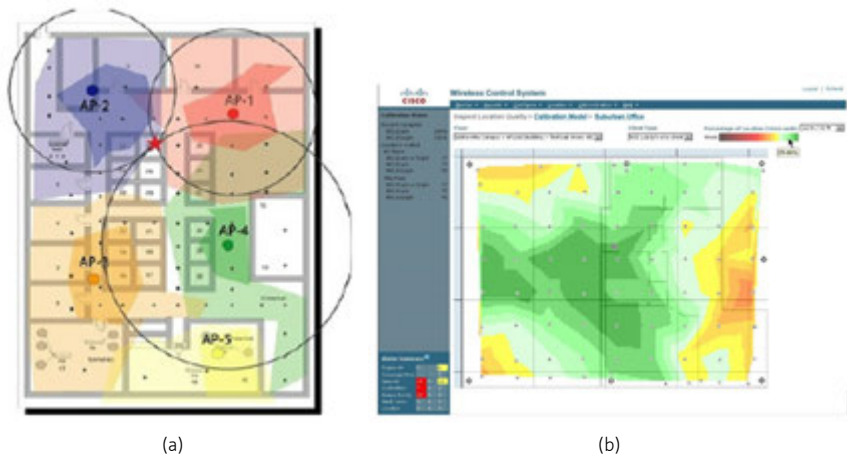

FIGURE 2.32 The principle of Wi-Fi indoor positioning. (a) Positioning from active points (from the webpage of Barcoding Inc. www.barcoding.com/wireless/asset_location_system.shtml); and (b) Fingerprinting map (from the webpage of Cisco www.cisco.com/en/US/docs/solutions/Enterprise/Mobility/wifich3.html).

Similarly, in robot motion, a planning occupancy grid approach uses a regular matrix of equally-sized cells for autonomous navigating robots [ME85, FMWN05]. In this matrix, each cell connects to its eight neighbouring cells (with the exception of boundary cells). A high probability value is assigned to grids in accessible/navigable spaces and a low value to grids occupied by objects.

A common Wi-Fi Positioning method is using the received signal strength indication (RSSI), *i.e.*, the power level received by sensors [CNPM11, Mau12]. This method collects RSSI from all *Wi-Fi active points (AP)* (Figure 2.32a) in a building and generates a 'fingerprinting' map. The 'fingerprinting' represents the expected distribution of *Received Signal Strength Indicator (RSSI)* (Figure 2.32b), which provides a position estimation for a user who can measure the RSSI at a location and compare it with the 'fingerprinting' map [VZVW⁺13].

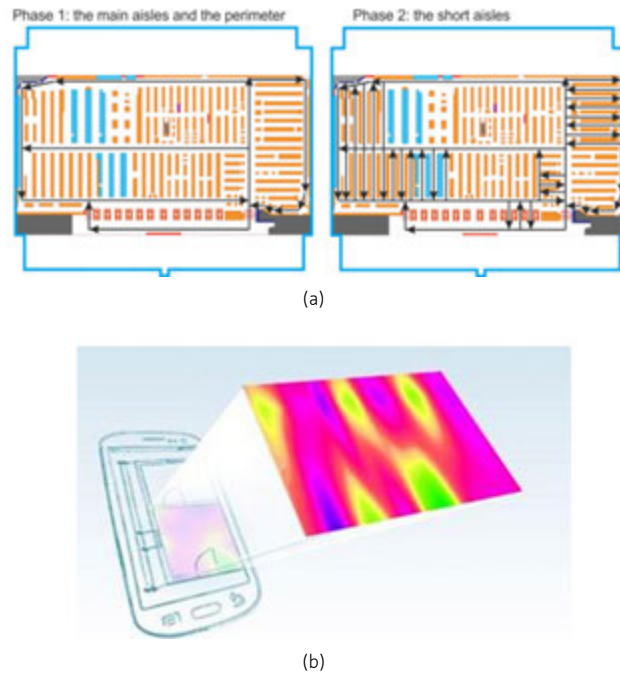

FIGURE 2.33 The principle of IndoorAtlas. (a) Aligning a floor plan; and (b) The generated magnetic map (from: www.indooratlas.com/).

Another similar method adopts the magnetic field for indoor positioning [Mau12, TMM⁺16], such as the application called IndoorAtlas [Ind16]. After aligning floor plan images with geo-coordinates (Figure 2.33a), IndoorAtlas collects data and generates a magnetic field map for the submitted floor plan (a type of fingerprinting map) (Figure 2.33b). As generally the magnetic field of each building is unique and different at various locations inside the building, this method can provide a relatively stable positioning result for the building.

With spatial information, one can conduct indoor tracking (*i.e.*, continuously following the trajectory of someone) with different localization devices. Commonly indoor tracking methods include: *Dead reckoning (DR)*, *Grid filter*, *Map matching*, and *Model-based approaches* [Mau12]. DR computes a person's current location by advancing a known position with course, speed, time and distance to be travelled. DR data can be collected by *inertial measurement unit (IMU)* [Mil06, Mau12] on tracking devices. The uncertainty of dead reckoning positions grows with time thus it is necessary to check the position regularly [Mil06].

A grid filter is a kind of discrete Bayesian filter, which probabilistically estimates a target's location based on observations from sensors [Mau12]. This type of method is widely used in the field of robotics [BFH97, TBF05]. They compute the location in two phases: the prediction phase where the prior probability of location is estimated based on the previous location, a motion model and the map of tracking environment; and the update phase where the posterior probability is computed by multiplying the prior probability with a conditional probability. The conditional probability is computed according to the measurements of sensors.

Map matching assumes a user can only be located along certain routes [Mau12]. Some constraints on indoor environments are applied to refine estimates of the moving positions of a person inside a building. For instance, a user does not pass through walls, but only along corridors and through doorways [Mil06]. Basically, there are two map-matching techniques: point-to-vertex matching (*i.e.*, a measured location to a vertex in the route), and point-to-edge matching (*i.e.*, a measured location to an edge in the route). An implementation of point-to-edge matching shows satisfied results in a corridor environment [Spa07].

Model-based methods adopt a vector model of an indoor environment to improve the estimation of user locations. This method can be taken as an extension of map matching methods. They consider model features (such as walls or obstacles) [GCZ⁺11], sensor information (*e.g.*, speed and direction), and information from users (*e.g.*, mean velocity and velocity variance [KKRA08]). Jensen *et al.* [LY09] propose a base graph model for tracking which represents the connectivity and accessibility of indoor space.

There are some other tracking methods for users. Optical tracking can be regarded as an alternative for users when positioning systems cannot work smoothly, such as identifying a user's location by matching photos provided by the user [ZV04]. Surveillance videos can also be applied to indoor user tracking. Zhou *et al.* [ZZW⁺16] adopt surveillance videos to extract single pedestrian traces, and then match the depth information of 3D scenes to the created indoor navigation network. In this way, pedestrian traces are reconstructed and visualized in the 3D indoor environment. This method is suitable for building managers who need to monitor a specific person's (*e.g.*, maintenance staff) trajectory in this building.

Girard *et al.* [GCZ⁺11] propose a real-time indoor navigation solution without pre-installed sensor networks, which combines four existing techniques: foot-mounted Inertial Motion Unit, ultrasonic ranging, particle filtering and model-based navigation. This solution shows an accuracy improvement compared to the previous indoor localization methods.

By using the Quoppa positioning technology (a localization system using a unique Angle-of-Arrival method of Bluetooth Low Energy signals) [LLC16], Van der Ham *et al.* [vdHZVV16] track the location of hospital assets. In addition, indoor spaces are subdivided according to these assets to improve accuracy. With such a subdivision the test shows a relatively good result [vdHZVV16]: there are four results with expected accuracy out of six cases.

In addition, a spatial model-aided approach is proposed to improve indoor tracking results [Xu14, LXPZ15]. This method integrates geometrical, topological and semantic features of a building to exclude locations with lower probabilities and improve a user's track from disordered measurement.

§ 2.6 Adopted methods in this thesis

For different components of indoor navigation, this research as described in the thesis selects and adopts specific methods concerning building models, navigation models and routing methods.

Building models. CAD models, IFC of BIM [IAI16] and CityGML LOD4 [GKNH12] data are all adopted in this thesis as input for indoor routing. The semantics of building are distinguished from the input data, according to a specifically designed data model (which will be introduced in Chapter 3). These semantics generally reflect navigational functions (*e.g.*, stairs assigned semantics Vertical Unit to connect distinct floors) of indoor spaces applied to different applications. In addition, the semantics of the designed data model are readily created or converted from the mentioned building models.

Navigation model (network). I take navigation networks as a navigation model since I want to explore the combination of topological and geometric networks for routing. Specifically, the used topological network is a pure graph structure and the geometric network is tagged with geometric coordinates. The navigation models represent a specific hierarchical model which separates the topological and geometric details from building models. In this way, indoor routing becomes simpler and more effective with the two navigation models: routing on the topological network excludes spaces according to certain criteria; then accurate paths in the selected spaces are computed in the limited geometric network of these spaces. Additionally, the specific hierarchical model contains just two levels of networks to avoid maintaining complex relationships among multiple levels. In other words, this research does not consider a hierarchy of different types of space (*e.g.*, section, room, and sub-room).

A Visibility Graph (VG) method [OW88, AW88] is used to support geometric network generation. An obstacle-avoiding path between two locations can be computed based

on the constructed VG. The two locations are represented by nodes of the geometric network and this path is the edge between them. Nodes of the geometric network can be doors or *Point of Interest (POI)*. A POI represents a location at or close to a specific indoor region (e.g., a vending machine). In this research a POI is considered as an abstraction of a region.

Routing methods. As this research focuses on the single-source path finding, the classic *Dijkstra* algorithm [Dij59] is adopted to find the shortest paths with different types of weights.

Routing criteria are designed for topological network, which is about the selection of spaces. The expected routing result is in the form of sequential rooms/spaces to be passed. These criteria are related to the centrality of a network and semantics of spaces (e.g., to minimize stairs in a path). In addition, three heuristics [CTG⁺06] for indoor wayfinding (central point strategy, direction strategy and floor strategy) are adopted to construct criteria for indoor routing (see Chapter 4). To reduce multiple candidate paths resulting from routing, *Lexicographical Goal Programming* [JT10] was adopted (see Chapter 4).

Routing based on geometric networks shows how to accurately navigate inside rooms / spaces, in terms of obstacle avoiding and accessibility to a given user. Thus the routing on a geometric network focuses on the accessible shortest path inside a space or between different spaces. The criterion of accessibility, which is related to user sizes, dominates the routing on geometric networks. In order to avoid and cross between obstacles, the *minimum distance* is used to indicate the 'bottlenecks' among obstacles. These bottlenecks among obstacles reflect a configuration of accessible regions in a space. Bottlenecks can be compared with a user size and then the accessible regions delimited for the user. The accessible regions can be computed not only for wheelchair users, but also for other applications (e.g., a person manipulating an indoor vehicle).

As mentioned in Chapter 1, indoor positioning techniques and indoor wayfinding is not researched in this thesis. Therefore, this thesis does not discuss or select related methods for the two purposes.

§ 2.7 Summary

This chapter introduces related research on different components of indoor navigation, *i.e.*, *building models*, *indoor navigation models*, *routing algorithms*, *human wayfinding behaviors* and *indoor positioning techniques*. Based on this chapter, the following research question is considered:

1. *What kind of information, data models and routing algorithms has been used and developed so far, and what are their limitations for large complex buildings?*

In general, indoor routing needs the semantics, topology and geometry of buildings. Indoor routing requires building models (Section 2.1) as input, such as CAD files of floor plans, standard data of city models (*i.e.*, *CityGML*) and standard data of buildings (*i.e.*, *BIM IFC*). CAD files lack the semantics of indoor spaces and the geometry can be very primitive (e.g., lines). Semantic models of *CityGML* and *BIM IFC* contain abundant space semantics and accurate geometry of these spaces (e.g, 2D surfaces or 3D

solid). Another standard model named *IndoorGML* focuses on indoor spaces and their connectivity for navigation networks. The navigation networks have to be converted from the building models. Semantics of indoor spaces should also be considered in the generation of navigation networks. There are many ontologies which define semantics in different ways. In order to apply any of the ontologies, one needs to consider the method of subdividing the building (e.g., based on structure or functions of spaces). Because the subdivision method is not clear, semantics of the reported ontologies are either too general or too detailed for different cases.

Navigation models (i.e., 2D/3D networks or grids) can be generated from the building models for indoor routing (Section 2.2). In general, there is no standard navigation model for every case of indoor navigation. Therefore, a navigation model needs to be selected according to the specific context.

Although shortest path algorithms such as *Dijkstra* [Dij59] and *A** [HNR68] are the base for indoor routing, many researchers propose *ad-hoc* routing methods and routing criteria relying on specific navigation models and user needs (Section 2.3). Except for *distance*, *travel time* or *number of turns*, non-metric factors are also used for routing (e.g., *cognitive similarity*, *temperature*, and *visual signs*). Some pedestrian-related paths are also defined, such as a 'feasible' and 'comfortable' path for a wheelchair user [DGK09a], *Least-effort*, or *Least-visible* paths [LZLF08, CWSC14]. Other routing methods are defined on specific navigation models or structures, such as *cactus tree-based* routing [WMY07], routing on an *Octree* structure from point clouds [RVZ16], etc.. However, two issues are seldom discussed for indoor pedestrian routing: 1) routing according to space semantics; 2) dimension of pedestrians. This thesis considers and designs related approaches for both the issues. First, different criteria are proposed to support indoor routing with space semantics (Chapter 4); second, a new indoor routing approach is developed to consider the size of users (Chapter 5).

The pedestrian wayfinding research (Section 2.4) shows some heuristics regarding human wayfinding behaviours, which can be considered to design routing criteria. Although indoor positioning techniques (Section 2.5) are important to provide and trace a user's location, in this thesis positioning is not the focus of indoor routing since the location can be reported or assigned by users.

Section 2.6 presents the methods adopted in this thesis, which is the starting point of this PhD research. This research adopted building data (*CAD* files, *CityGML LoD4* and *BIM IFC*), navigation networks, and the *Dijkstra* algorithm for routing. Based on these existing methods, the focus is to facilitate the generation of navigation networks from building data, and on user needs of passing through specific locations and/or spaces in path computations. In addition, user size is considered for accessible path computation in this research. The next chapter will present the developed data model mapping indoor spaces to navigation networks according to space functionalities, and the two-level routing approach on these networks which considers user needs and their sizes.

3 Space modelling for two-level routing

This chapter presents an indoor routing approach which incorporates building information on two levels, *i.e.*, *abstract* and *detailed* levels (which relate to *logical* and *geometric* networks, fully described in Chapter 4 and Chapter 5, respectively). The two levels are built based on indoor spaces. In this thesis an indoor space is defined as a volume with a conceptual or physical boundary. Such a space can be partially occupied (*e.g.*, by the volume of a coffee machine or other furniture/obstacles) or empty. The two levels refer to two navigation networks regarding indoor spaces. The navigation network on the abstract level provides a topological representation of a building, *e.g.*, a connectivity graph among all the spaces of the building. The navigation network on the detailed level represents accurate paths through geometric locations along various obstacles related to these spaces. The two-level routing integrates both the networks to compute paths considering user preferences for spaces and/or geometric locations.

Section 3.1 explains the basic terms used for the two-level routing approach and defines navigation networks on the two levels. In Section 3.2, a conceptual data model is proposed to capture different spaces of a building and depict the relationships of the spaces. This data model is used to bridge building data to navigation networks on the two levels. Section 3.3 elaborates the relationships between navigation networks on the two levels and the proposed data model. Section 3.4 presents routing options either on the abstract or the detailed level and introduces some combinations that use the two levels together for routing. Compared to a one-run routing in a whole navigation network, the two-level routing approach provides more flexibility (*e.g.*, to get an abstract and/or a detailed path according to user demands) and more routing functionalities (*e.g.*, through assigned ordered spaces of interest (SOI) and points of interest (POI)). This chapter is related to the following author's own publications: [LZ12, LZ13b].

§ 3.1 Concept, definitions and terminology

This two-level routing concept is the theoretical foundation for the whole thesis. The two-level routing approach is a synthesis computation integrating routing on both the abstract and detailed levels. On the abstract level one can compute and adapt a conceptual path (*i.e.*, a sequence of spaces) to user needs, on the detailed level one can obtain accurate paths that suit user sizes to avoid obstacles. Routing on the abstract level enables a user to add her/his preferences for specific spaces. Depending on spaces in a computed conceptual path, a navigation network on the detailed level is built in these spaces with consideration of user size. In other words, the two-level routing is not based on a pre-stored complete navigation network that covers all the spaces of a building. Instead, the indoor navigation networks are generated 'on the fly', and they are easily recreated when the indoor environment partially changes (*e.g.*, a space is locked or furniture is moved). In the two-level routing approach, an 'optimal' (*e.g.*, the shortest distance or time) path is not the focus. Because this approach gives priority to indoor navigable spaces and their functions for routing, and takes the spaces to delimit indoor paths by determining different space sequences according to user profiles

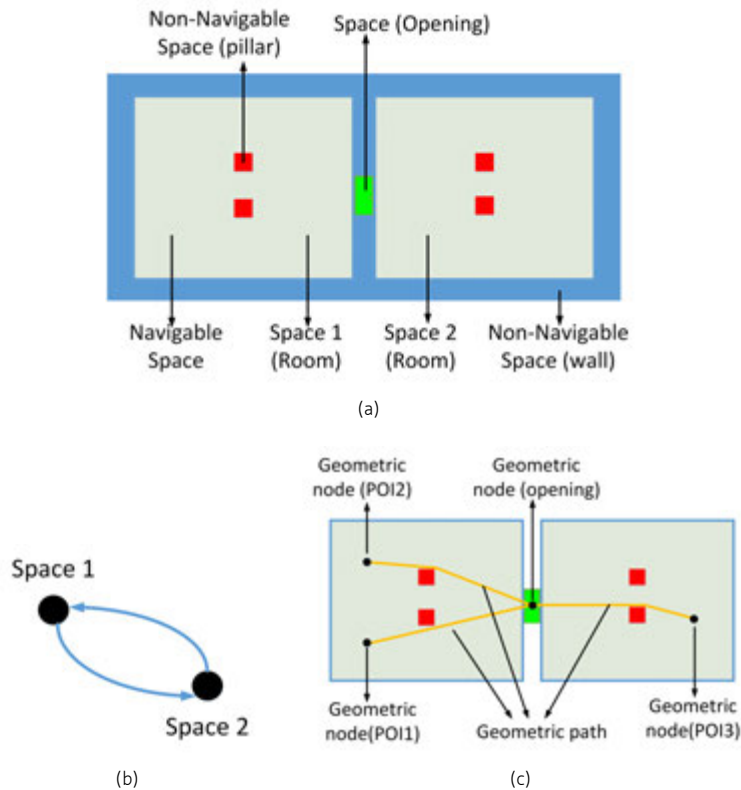

FIGURE 3.1 Concepts of indoor space. (a) Description of Space, Navigable Space and Non-navigable Space; (b) The dual graph of Space 1 and Space 2. The graph is bi-directional; and (c) POI, Geometric node and path.

and preferences. Geometric paths (on the detailed level) are refined in a given space sequence (e.g., a path on the abstract level). This coarse-to-fine approach of two-level routing could exclude a part of the indoor spaces on the abstract level, and thus the so-called 'optimal' paths are not ensured.

The introduction of all concepts starts from *indoor space*. An *indoor space* ('space' for short) is a volume physically or virtually bounded. A room in a building is considered space. The connection volume between two rooms is named an *opening*, and the volume of opening is also space. An opening can be occupied by a door/window panel. Indoor objects are regarded as static obstacles. They are also space that may occupy a part of a room. Thus a room can be fully empty, partially occupied (e.g., a room with obstacles) or fully occupied (e.g., that of an obstacle). It is possible to have one space in another (pillar in a room, see Figure 3.1a). For a room with static obstacles, the free part is named *Navigable Space* for motions, while the obstacle part is named *Non-navigable Space*. A *Wall* is another type of *Non-navigable Space* (Figure 3.1a). It bounds a room from the outside and no human or robot user can move in it.

Chapter 2 (see Section 2.1) has introduced structural and functional subdivision of buildings, which can result in physical and virtual spaces, respectively. These spaces can be further split into more small pieces or integrated into a larger one. A building is finally represented by a number of spaces. A *dual graph* of these spaces can be created: selected spaces are abstracted as nodes, and edges of the graph represent connectivity (see Figure 3.1b). This *dual graph* is the navigation network on the abstract level. Space semantics can be assigned to related nodes. As these edges just represent connectivity, no semantics would be assigned to these edges. But edges can indicate the direction of access permission of a space and motion modes of humans (e.g., edges for a walking person or wheelchair user).

Two important concepts are introduced in this thesis: *Space of Interest (SOI)* and *Point of Interest (POI)*, see Figure 3.1c). A SOI is a region which a user wants to visit. Examples of SOIs are coffee machine neighbouring areas, registration desk front areas, waiting areas, a specific door or even a user-defined place. In particular, a SOI is a whole (i.e., a corridor) or a part of space.

SOI refers to the space as a concept (i.e., the name of a room or a place), POI is a location at or close to a SOI, or contained in a SOI (when the SOI is a whole space). A POI is given with its three-dimensional coordinates, e.g., a point in front of the coffee machine. Generally, a POI can be any location in a building. But a POI should refer to useful information, thus in this thesis a POI is defined as an abstraction of a SOI (e.g., functional spaces and physical spaces such as an indoor obstacle). For example, in the case of a door or window, POIs can be the centre point of the shape. A POI can also be created with indoor obstacles: a reference point of an obstacle is considered a POI. Normally the POI is close to the obstacle and accessible to the user, such as a nearby location to a coffee machine. Subspace would be created for the POI by users. The POI inherits the name of the related subspace ('coffee machine', 'reception desk', etc.). In this respect SOIs are used on the abstract level and POI on the detailed level.

This thesis makes a distinction between two categories of indoor navigation networks, i.e., logical and geometric (on the aforementioned 'abstract' and 'detailed' levels, respectively, see Chapter 1). The logical network is about the connectivity of indoor spaces and it represents an *abstract* routing network for a building, while the geometric network is created in navigable spaces, and it is the *detailed* routing network for the building. The two types of network are defined as a set of nodes and edges. Their definitions are presented as follows.

Definition 1 Logical network. A logical network is a directed graph $G_l = \{V_l, E_l\}$ where V_l is the node set representing indoor spaces, and

$$E_l = \{e = (n_i, n_j) | (n_i, n_j \in V_l) \cap (n_i, n_j \text{ are the spaces sharing openings})\}$$

An edge indicates two spaces connected via an opening. In other words, edges of the logical network are connectivity of spaces and they are directional. Given a set of indoor spaces, the logical network is a connectivity graph regarding these spaces.

Definition 2 Geometric network. It is a network $G_g = \{V_g, E_g\}$ where V_g is the node set including opening centres and *Points of Interest (POI)* in a set of indoor spaces, and

$$E_g = \{e = (n_i, n_j) | (n_i, n_j \in V_g) \cap (n_i, n_j \text{ are in the same space})\}$$

$$\cap (\text{there is the shortest distance path between } n_i \text{ and } n_j)$$

The nodes in V_g represent indoor transfer locations (e.g., door centres) and POIs with coordinates. Normally nodes regarding openings are constant but POI nodes can be added on demand. The edges represent the obstacle-avoiding path with the shortest distance (the *shortest path* in short) between two nodes related to the same space. This definition of edge delimits the number of edges. Thus, in a geometric network, there is no edge for two nodes pertaining to different spaces. Then the shortest path between the two nodes can be computed based on edges. Edges of a geometric network are derived with the building geometry (i.e., shapes of spaces, obstacles and openings). An edge may not be a straight line but a polyline (with many intermediate points except the two nodes). A geometric network can be assigned to any number of spaces in a building. Given a set of indoor spaces, each space contains a subnetwork of the geometric network.

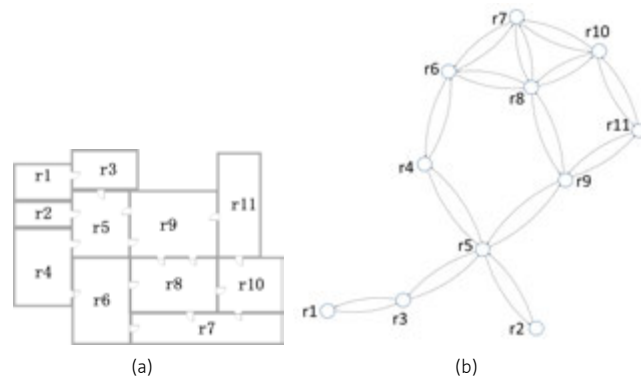

FIGURE 3.2 Logical network of spaces. (a) Indoor spaces of a design plan; and (b) The logical network.

The term *logical network* refers to topological relationships only of indoor spaces regardless of geometric information of buildings. In this thesis, the nodes represent a building's navigable spaces (e.g., rooms or corridors) without coordinates, i.e., they are not geometrically defined. The edges represent only the topological relationship (connectivity) between the spaces. The nodes inherit only the semantics of related spaces. Figure 3.2 provides the logical network for several rooms. No geometric information is attached to the logical nodes and the edges. The paths in logical networks are named *logical paths*.

Two geometric networks in Figure 3.3 are created with the same spaces as Figure 3.2 but with different geometric information. Figure 3.3a presents an example of visibility graph (VG); and Figure 3.3b presents the case of a straight medial axis. Paths in geometric networks are named *geometric paths* that consist of a sequence of nodes and related edges. As mentioned in Chapter 2, this thesis adopts a VG approach [AW88, dBCvKO08] to derive geometric networks.

The 'two-level' notion is inspired by an important A* technique named *Hierarchical Pathing* in computer game programming [Rab00]. In *Hierarchical Pathing*, the first

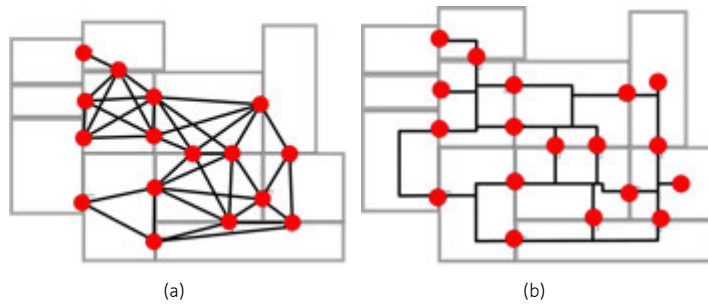

FIGURE 3.3 Instances of geometric networks. The nodes represent locations at doors. (a) A geometric network with nodes at the doors, and edges representing visibility edges; and (b) A geometric network with edges representing a straight medial axis.

step is to find the overall path, and the second step is to refine path on the local level. Both the paths refer to geometric paths.

In this research, the notion of two levels is defined by using the logical and geometric networks. The *abstract level* focuses on connectivity of navigable spaces, and routing is conducted in a *logical network* of a building. The *abstract level* is used to indicate how to pass spaces. The *detailed level* focuses on the geometric aspect of paths. A *geometric network* is created on the detailed level within the selected spaces.

On the *abstract level*, routing relies on the spaces' semantics, which will be elaborated in Chapter 4. In the next section, a data model for the representation of the semantics is introduced. The model contains dedicated semantics to support the generation of logical networks and to categorize spaces with the semantics.

Figure 3.4 gives a simple example of the logical and geometric networks of a single floor (Figure 3.4a). Consistent with the structural subdivision of the floor, the resulting navigable spaces are selected to form a logical network (Figure 3.4b). A logical path is defined on the navigable spaces R1, R2 and R3, and the geometric network (see Figure 3.4c) considering doors is created within these three spaces for routing (*i.e.*, formed by three sub-networks of each space). The constructed geometric network is based on the shortest paths between the doors (Figure 3.4d). Such networks and related routing on the detailed level will be elaborated in Chapter 5.

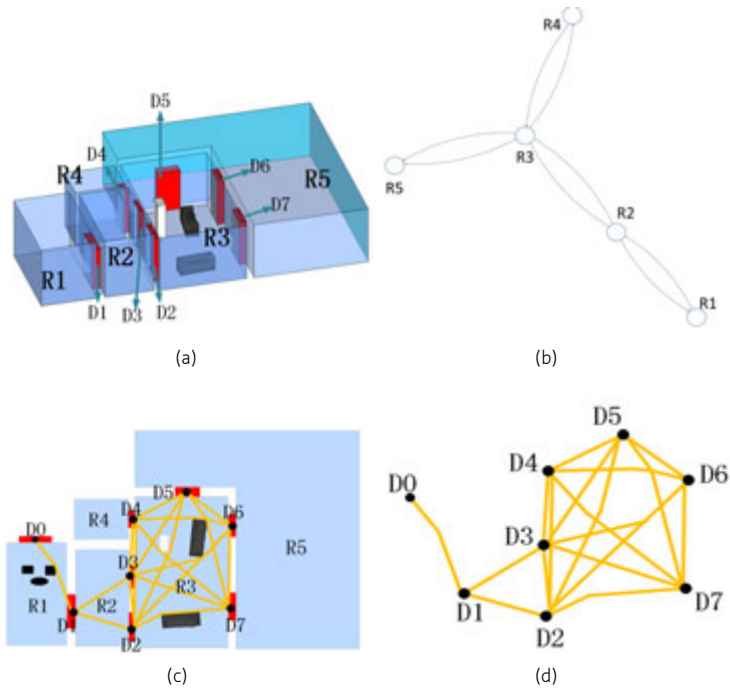

FIGURE 3.4 Illustration of logical and geometric networks. The logical network is the 'space-to-space' style. (a) A floor of five spaces; (b) A logical network for spaces on the floor; (c) A related geometric network. Nodes are door centres, and edges represent the shortest paths among the nodes; and (d) The geometric network only for R1, R2, and R3.

§ 3.2 Indoor navigation space model (INSM)

Indoor space is a fundamental aspect for indoor navigation. These spaces derived from a whole building space with given semantics contribute to indoor routing, because indoor routing is based on the navigation models of these spaces. As addressed in Chapter 2, shortcomings of previous research on pedestrian navigation networks can be summarized by the following:

1. A limited link between indoor space subdivision strategies and routing. The generation of navigation networks for different buildings is not well defined. Most research shows the navigation networks of simple-structured buildings, while few studies discuss those of complex buildings where different subdivision strategies can be applied.
2. Separate semantics of indoor spaces, or even no semantics in some applications. On the one hand, some navigation networks adopt different semantics which have different names for the same type of space or provide distinct definitions of spaces and objects (e.g., the models *IndoorGML* and *3DBO*, see Chapter 2). On the other hand, many navigation networks are purely geometric without space semantics.
3. Limited consideration of indoor routing with obstacles. A few navigation networks [GZ11b, LY]S09, SR09, MZLC14] link obstacles to the network generation and routing. But the influence of changes on obstacles or users is not clearly addressed. In contrast, obstacles and user sizes are commonly considered in robot navigation whose routing is mostly based on Minkowski sums [dBCvKO08, Coe12] (see Chapter 2).

This section presents a proposed spatial-semantic coherent data model named the *Indoor Navigation Space Model (INSM)*. This model is specifically designed to define indoor spaces by their navigational functionalities, and to support indoor routing in different environments/scenarios with distinct subdivision results. The INSM model concentrates upon the ‘functional’ spatial semantics such as distinct spaces specifically for horizontal and vertical motions (corridors and stairs), and the connection part of these different spaces.

Moreover, the INSM is developed to distinguish the use of semantics and geometry of buildings. As mentioned above, semantics of different data models (e.g., CityGML and BIM IFC) are not completely compatible and they are seldom directly used for indoor routing. Thus, INSM semantics are designed to support indoor routing where semantic routing criteria can be developed (Chapter 4).

In terms of indoor semantic models, there are two prominent alternatives for routing *i.e.*, *3DBO* and *IndoorGML* (see Chapter 2). The semantics of *3DBO* are too specific and detailed; it separates similar spaces (e.g., passage and corridor), which is unnecessary according to space functionality (passages and corridors are both for horizontal movements).

The other data model - *IndoorGML* - is more general and similar to INSM. The main difference between them is that *IndoorGML* only contains a network (the *Core* module). The network of navigable spaces (the *Navigation* module) is not compulsory for *IndoorGML*. *IndoorGML* defines the network of indoor spaces based on space connectivity, which can be used for the logical network (*i.e.*, the abstracted level), but more

geometric information is not included in the *IndoorGML*. For example, POI is not explicitly defined in *IndoorGML*, and POI can frequently be used for routing. In contrast, INSM is space-centred and facilitates the generation of navigation networks of the two-level routing. In fact, INSM is proposed earlier than the *IndoorGML* and it is specifically designed to support the two-level routing.

In general, INSM is devised to manage functional space semantics, topology and geometry. INSM regards each component of a building as a space (either occupied by objects or not), and the semantics of a space indicate its functionality in a navigation process. As INSM explicitly contains connectivity among spaces, logical networks can easily be generated. Furthermore, with INSM the semantics of spaces can be propagated to nodes of logical networks. The building geometry stored in INSM can be used to create specific geometric networks, which derive obstacle-avoidance paths for users with different sizes.

The main characteristics of INSM are:

1. Space subdivision of a building into non-overlapping spaces;
2. Dedicated semantics which represents these spaces according to their functionalities for indoor routing;
3. Possibility to automatically derive a semantically rich logical network. The generation process uses the concept of *Duality* as in *IndoorGML* (see Section 2.2);
4. Possibility to automatically derive geometric network.

Indoor spaces referred by INSM can be either three-dimensional (3D) volume/solid or two-dimensional (2D) surface/area. For simplicity, in the implementation of these concepts (see Chapter 6) paths are computed based on the non-overlapped surfaces in 2D and 3D spaces (e.g., 2D for horizontal spaces and 3D for stairs). Therefore, the INSM discussed below adopts surface geometry to represent spaces.

Following the data modelling tool *Sparx Systems Enterprise Architect*, INSM is presented by two UML class diagrams which are independent of *platform-* and *technical-specific* information. The first one contains only classes without attributes; the second includes the classes and their attributes.

The INSM model in the first form is profiled in *Unified Modelling Language (UML)* by using the *Enterprise Architect* (Figure 3.5). It includes the classes of indoor spaces and their aggregation classes, their compositions and other associations. Figure 3.6 presents the main part of the INSM model with attributes.

The fundamental classes to the INSM are the *Opening (OPN)*, *NavigableUnit (NU)*, and *NonNavigableUnit (NonNU)* (the yellow boxes in Figure 3.6). The following part elaborates on the main classes of the INSM.

Definition 3 Opening (OPN). This is a transition space which connects one space with another. These spaces (e.g., an entrance) can connect the outdoor space as well.

An *OPN* can be a *Door*, a *Doorway*, *MainEntry* or a *Window*. The *OPN* contains attributes that characterize properties of importance for navigation such as: the entity of *OPNs*



FIGURE 3.5 The INSM model represented only by classes. All classes refer to spaces except PointOfInterest. PointOfInterest represents POIs (locations with coordinates). A part of the classes is aggregation classes, i.e., VerticalSpace, HorizontalSpace, NavigableBuildingSpace, BuildingPart and Building. The other classes refer to independent spaces.

(*IsExisted*), the adjacent spaces or spaces that the opening links (the association *Space1 / Space2* in Figure 3.6), and accessibility of the space (*IsLocked*). The *OPN* has five subtypes, i.e., *Door*, *FacadeWindow*, *InteriorWindow*, *Doorway* and *MainEntry*. The type *Door* is critical for routing as it provides the connectivity of spaces. The type *InteriorWindow* and *FacadeWindow* can be used in routing in special cases (e.g., an emergency). *FacadeWindow* refers to the link to the outdoor space. The *Doorway* is a special type to depict cases where no physical boundary between two spaces exists. For example, the gap between two spaces, when a movable wall is removed, is a doorway. Lastly, *MainEntry* represents the connection to the outdoor space (e.g., the main entrance).

Definition 4 NavigableUnit (NU). This is a space in which users (e.g., pedestrians) can move freely (e.g., walk or drive) without crossing any opening.

Each *NU* class has as attributes the heights of the space (*BottomHeight* and *TopHeight*) and the *Name* of the *NU*. The attribute *Name* is used for the abstract routing, i.e., these are the names used by a user.

Definition 5 SpaceOfInterest (SOI). This is a sub-region of *NU* assigned by a user for specific purposes.

A *SOI* refers to a navigable region that can be contained in a *NU* or just the *NU* itself. The *SOI* reflects a user's interest in visiting this specific region. For example, in a public space the front area of a coffee machine is a *SOI*, and a corridor (also a *NU*) is a *SOI*. Each *SOI* associates with only one *NU*, while a *NU* corresponds to none or many *SOIs* (see Figure 3.6), which indicates a user can separate several regions in a *NU* as *SOIs*. The class *SOI* includes the attribute *Name* to store the descriptor of the region.

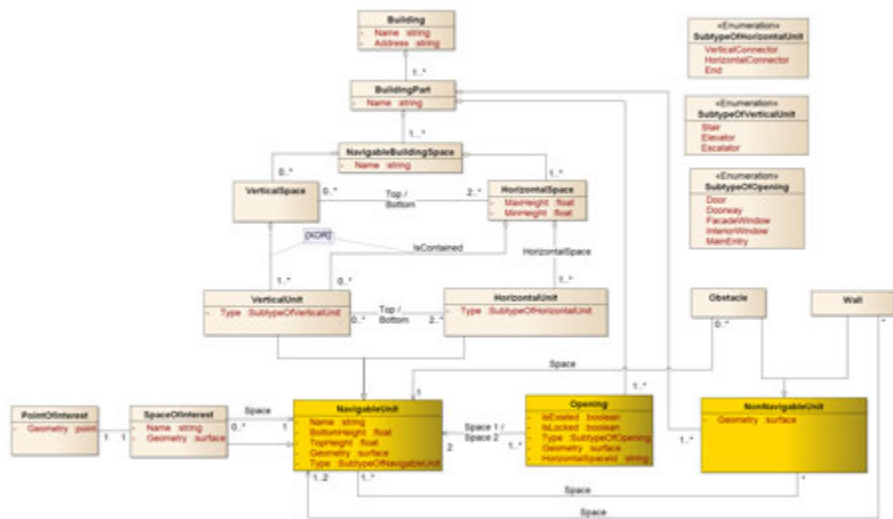

FIGURE 3.6 The main part of INSM with classes and attributes. The yellow boxes represent the fundamental classes: NavigableUnit, Opening and NonNavigableUnit. The off-white part includes derived classes of three fundamental classes, other aggregation classes, associated classes and data types.

Definition 6 PointOfInterest (POI). A *POI* is the reference location of a *SOI*.

The class *POI* is associated to the class *SOI* with a 1-to-1 relationship (see Figure 3.6). For instance, a *POI* can be door centres, obstacle corners, or any user-defined location in *NUs*. The class *POI* contributes to routing on geometric networks. More details on geometric networks will be given in Section 3.3. A *NU* may contain none or many *POIs*, but a *POI* can be only contained in one *NU*.

Definition 7 NonNavigableUnit (NonNU). This is a space occupied by objects in which pedestrians cannot be present.

The *NonNU* consists of two subclasses, *i.e.*, the classes *Wall* and *Obstacle* (see Figure 3.5). An *Obstacle* is the inaccessible space inside *NU*, such as a pillar or furniture. In contrast, a *Wall* cannot be in a *NU*. A *Wall* is an inaccessible space that is adjacent to a *NU* and bounds the *NU*. In the 2D space, the representation of a *NonNU* is a surface and in 3D it is a volume. The association *Space* of the class *Obstacle* gives the *NU* containing the *Obstacle*. The class *Wall* can touch two *NUs* or one *NU* and the outdoors, which is given by its association *Space*.

The class *NU* represents all kinds of indoor spaces. Generally, two *NUs* are connected via one or more *OPNs*. The multiplicity between *NU* and the *OPN* is 1 to many, because a *NU* can relate to from 1 to multiple *OPNs* (*e.g.*, *doors*), and conversely an *OPN* is associated with 2 *NUs*. In addition, the class *NU* is associated to the *NonNU*. The multiplicity between *NU* and *NonNU* is 1 to many, which indicates a *NonNU* may be related to 1 or many *NUs*. Conversely, a *NU* associates with many *NonNUs*.

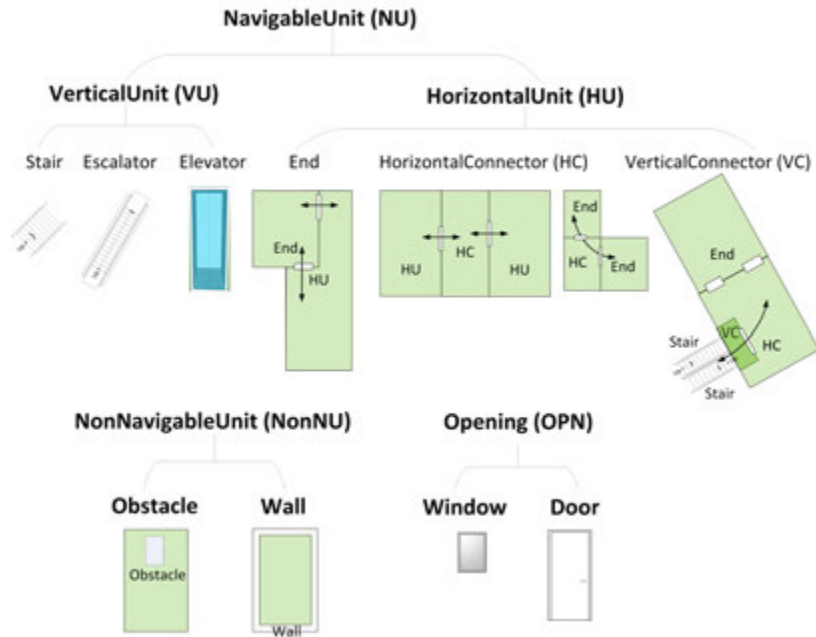

FIGURE 3.7 Illustration of core classes of the INSM, including NU, VU, HU, End, HC, VC and OPN, etc.

Definition 8 VerticalUnit (VU). *VU* is a subclass of *NU* in which pedestrians can move (or be transported) in vertical directions (*i.e.*, up and down) along the same slope.

Definition 9 HorizontalUnit (HU). This is a subclass of *NU* in which pedestrians can move in horizontal directions.

The *Vertical Unit (VU)* and *Horizontal Unit (HU)* (see Figure 3.5 and Figure 3.7) are exclusive subclasses of the *NU*. A user's vertical and horizontal movements in a building are bounded to the two classes.

The *VU* has the association *Top/Bottom* to give the two *HUs* connected by it. Another attribute *IsContainedVerticalUnit* records whether the *VU* is contained in a *HU*. The *HU* indicates its *HorizontalSpace* (the definition will be given after) information by its aggregation *HorizontalSpace* (see Figure 3.6). Generally, an *HorizontalSpace* is similar to the general notion 'floor'. A *VU* can connect two *HUs* or even more, such as an elevator connects every floor of a building. An *HU* may not associate any *VU*, or link many *VUs* (*e.g.*, an entrance hall to several stairs).

Both the *VU* and the *HU* (see Figure 3.7) are too general to describe the use of a space for indoor routing. In fact, a user does not consider two *HU* spaces (*e.g.*, a corridor and a balcony) equally important for routing. Similarly, *VU* spaces such as stairs and elevators are not equally important for routing. Therefore, subtypes are designed for the *VU* and *HU*.

The *VU* has three subtypes *Stair*, *Escalator*, and *Elevator* (see Figure 3.5 and Figure 3.7). They support different modes of vertical motions in a building. The *Stairs* are used for walking; a user can save effort by using the *Escalators* and *Elevator*. The three subtypes are simplified in the attribute *Type* of the *VU* (see Figure 3.6). The *HU* has three subtypes *End*, *HorizontalConnector (HC)* and *VerticalConnector (VC)* (see Figure 3.5), which are introduced below.

Definition 10 End. *End* is a subtype of *HU* which is connected with one *NU* at most.

Definition 11 VerticalConnector (VC). $VC := \{NU_i \in NU \mid \forall NU_i, \exists \text{connected } NU_m, NU_n \in NU, m \neq n : (NU_i \in HU) \cap (NU_m \in VU) \cap (NU_n \in VU)\}$.



FIGURE 3.8 An example of the VC. The iron platform is a VC connecting the two escalators.

A *VC* is a *HU* which connects at least two other different *NU*s, and at least one of them is a *VU*. Although a *VC* is for horizontal motions, its name include 'vertical'. That is because the *VC* connects a *VU* at least, and it is the joint connecting the horizontal and vertical parts. In the case that a *HU* directly connects to a *VU*, a *VC* may be a virtual space that includes no physical walls. A *VC* (see Figure 3.8) can be divided from the *HU* manually. The *VC* benefits the routing with semantics of spaces: *VC*s would be searched first when a user needs to switch floors. The *VC* is an indication of possible floor changes. In contrast, an *HC*, another subtype of *HU*, cannot provide such information.

The *VC* is an important subtype in the INSM. Although a *HC* and a *VU* may connect each other directly, the *VC* is an indication to find *VU* quickly. It is called *VC* because it connects vertical parts. A *VC* is a virtual space in a space which is contained in a *HU*. The semantics of the *VC* refer to connections of vertical and horizontal parts, which has benefits for routing.

A *VC* is supposed to be a small space covering the entrances of the *VU*, and therefore it bridges the *VU* and the other *HU*. Thus a *VC* cannot be a *HC* (connecting at least two *HU*s) at the same time. The size of a *VC* is flexible, which can be decided according to its capacity of pedestrians [KZ14]. In Figure 3.7, the *VC* connects the two stairs to the upper and lower floors, respectively. Meanwhile, the two stairs are connected to a *HC* via this *VC*.

According to the *VC*'s definition, the subtype *VC* is associated to the *VU* and *HU*. A *VC* may connect to 1 or many *VU*, and link to 1 or many *HU*. As a *VU* bridges at least two floors, the *VU* connects at least two *VC*s. A *HU* may be not related to a *VC* (i.e., only to other *HU*s), thus a *HU* is associated to none or many *VC*s.

A *HC* is a *HU* which connects at least two other different *HUs*, and all of them belong to the same *HorizontalSpace* (see Figure 3.7). Thus, a *HC* associates to at least two other *HUs* (see Figure 3.5). Conversely, a *HU* may be an *End*, then a *HU* connects to none or many *HUs* (see Figure 3.5 and Figure 3.7). The definition of *HC* will be provided after the definition of *HorizontalSpace*.



FIGURE 3.9 An example of the *VU* contained in a *HS*. The red box highlights the space of the steps (*VU*) contained in the larger *HU* space.

Definition 12 HorizontalSpace (HS). A *HS* is a collection of *NUs*, where the maximum of their *top heights* (*topH*) is denoted by *MaxH*, and the minimum of their *bottom heights* (*botmH*) by *MinH*. These *NUs* include both *HUs* and *VUs* whose *botmH* and *topH* are not lower than *MinH* and not higher than *MaxH*. $HS := \{HU_i \in HU, VU_k \in VU \mid \forall HU_i, \exists (MinH \leq botmH_i < MaxH) \cap (MinH < topH_i \leq MaxH); \forall VU_k, \exists (VU_k \text{ is contained in } HU_i)\}$.

The class *HS* is an aggregation class of the two classes *HU* and *VU*. The two values *MaxH* and *MinH* are stored in the attributes *MaxHeight* and *MinHeight* of *HS* (see Figure 3.6). A complicated floor that contains intermediate levels can be represented by the *HS*. In the INSM model with classes and attributes, *HU* aggregates to *HS* in the relationship *HorizontalSpace* and *VU* uses an aggregation *IsContained* to indicate the *VUs* contained in *HS*. A *HS* includes one *HU* at least (the multiplicity 1...*). The *HS* may contain none or many *VUs*, thus in the *IsContained* aggregation relationship the multiplicity on the *VU* side is from 0 to many. Figure 3.9 presents the case that a *HS* contains some steps as a *VU*. Here the contained *VU* is useful to depict irregular shapes inside a building, especially for the case that a floor contains small steps or a small stair to a hanging platform (see Figure 3.9).

Definition 13 HorizontalConnector (HC). A *HC* is a *HU* that connects with at least two other *HUs*. $HC := \{HU_i \in HU \mid \forall HU_i, \exists HU_m, HU_n \in HU, HU_i \in HS :$

$$(HU_i \text{ connects } HU_m) \cap (HU_i \text{ connects } HU_n) \cap (HU_i, HU_m, HU_n \in HS)\}.$$

The definition of the class *HC* relies on the *HS*, because a *HC* connects with other *HUs* on the same *HS*. The *HC* represents passages, corridors and halls in a *HS*.

Definition 14 VerticalSpace (VS). A *VS* is a group of *VUs* whose maximum height difference is less than a threshold *MaxDist*. $VS := \{VU_i \in VU \mid \forall VU_i \notin CVU, \exists VU_j \in VU \text{ and } VU_j \notin CVU : \text{the distance between } VU_i \text{ and } VU_j < MaxDist\}$.



FIGURE 3.10 The VerticalSpace (in blue) and HorizontalSpace (in green). There are four HorizontalSpaces (e.g., a part of or a whole floor) and two VerticalSpaces (e.g., stairs).

The *VS* is the aggregation class of *VU*. A *VU* is either aggregated to the *VS*, or to the *HS* (Figure 3.6). A *VS* contains at least one *VU*, then the multiplicity on the *VU* side is from 1 to many. A *VS* represents a complete staircase or elevator, and a *VU* is only a part of the *VS*. The class *VS* has an association *Top/Bottom* which refers to the connected bottom and top *HS* of the *VS*. A *VS* connects to at least two *HSs* (multiplicity from 2 to many on the *HS* side in Figure 3.6). In contrast, the multiplicity is from 0 to many on the *VS* side in the association *Top/Bottom*. This is because a *HS* may not connect to any *VS*. Figure 3.10 presents examples of the *VS* and the *HS*. The green parts are *HSs*, and the blue parts are *VSs*. The *VSs* have different ranges, which means they connect to different top or bottom *HSs*. For the two *HSs* on the top level, one of them connects to a *VS*, and the other one is not related to any *VS*. The remainder of the *HSs* links to the two *VSs*.

Definition 15 NavigableBuildingSpace (NBS). The *NBS* is the collection of all the *NUs* of a building. $BS := (VS \cup HS)$.

The *NBS* is an aggregated class which represents part of or the overall navigable space of a building, such as all the walkable spaces in two *HSs* (e.g., floors) and in the related *VSs* (e.g., stairs) connecting the two *HSs*. In addition, the *NBS* may not include *VSs*, and it has a *HS* at least, such as a construction with only one floor. The *NBS* class contains an attribute *Name* to store its depictor.

Definition 16 BuildingPart (BP). The *BP* is the collection of all the *NUs*, *NonNUs* and *OPNs* of a building. $BP := (NBS \cup OPN \cup NonNU)$.

The *BP* is aggregated by *NBSs*, *OPNs* and *NonNUs*. A *BP* contains 1 or many *NBSs*, 1 or many *OPNs* and 1 or many *NonNUs* (see Figure 3.6). The *NBS* refers to the ‘free’ space in a building. Together with *OPNs* and *NonNUs* (e.g., walls), the *BP* refers to a complete notion of building space where the *NBSs* are connected with *OPNs* but occluded by *NonNUs*. The *BP* class has the attribute *Name*.

Definition 17 Building (BLD). The *BLD* is the aggregation of *BPs*. $BLD := (BP_1 \cup \dots \cup BP_k, k \geq 1)$.

An example of the *Building (BLD)* is two constructions connected by a connecting bridge. The two constructions and the bridge are *BPs*. The *BLD* class includes an attribute *Name* to store the name of a building (see Figure 3.6). The *BLD* uses *Address* to record the

unique address of the building. A *BLD* may consist of one or many *BPs* (e.g., constructions connected by bridges).

In this thesis *INSM* is compared to two semantic data models, i.e., *IndoorGML* [LLZ⁺14] and the *3D Building Ontology (3DBO)* [GZ11a]. *IndoorGML* is a standard of *Open Geospatial Consortium*, and it is worthwhile to clarify the connection between *INSM* and *IndoorGML*, which can benefit data transformation from the standard dataset. Semantics of *3DBO* are comprehensive but no related navigation cases are reported. With the comparison to *3DBO*, one can find in *INSM* the more concise semantics necessary for indoor routing. For example, *Room* and *Hall* of *3DBO* can both be mapped to *HU*, and *Corridor* and *Horizontal Passage* of *3DBO* can be sorted to *HC* (see Figure 3.12).

Compared to *IndoorGML*, the semantics of *INSM* is proposed earlier (in 2012) and more specific for navigation. Figure 3.11 presents the relationships between the two sets of semantics. The semantics of *HC*, *VC* and *VU* in the *INSM* are all equivalent to the *TransitionSpace* of *IndoorGML* (see Figure 3.11). Thus, horizontal and vertical spaces referred to by the *HC*, *VC* and *VU* are not separated in the *IndoorGML* as well. The navigation module of *IndoorGML* separates vertical and horizontal spaces according to the types of space provided by the *OmniClass* [Sec16] standard. For example, a *TransitionSpace*, can be regarded as ‘horizontal transition’ using code 1000 and as ‘vertical transition’ using code 1010 [LLZ⁺14]. However, this coding is not explicitly visible in the logical network.

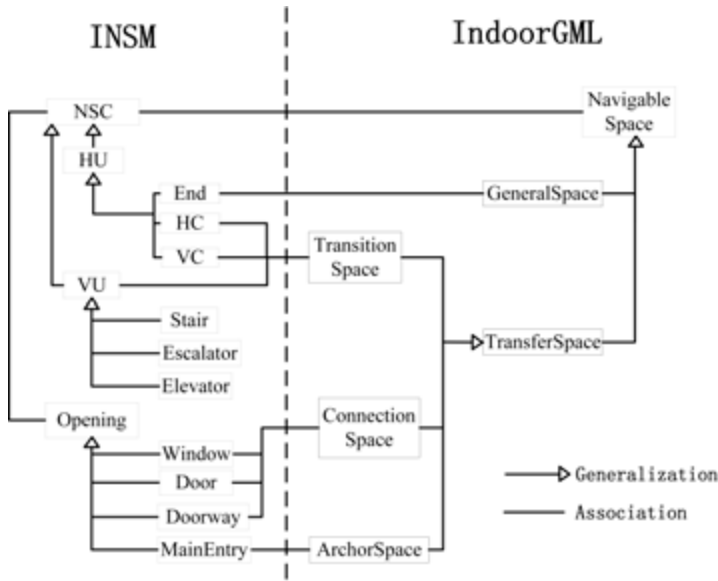

FIGURE 3.11 The associations of essential semantics of the *INSM* and the *IndoorGML*.

Detailed indoor semantics certainly bring more information for semantic paths. The *3DBO* provides more details of spaces than the *INSM* (see Figure 3.12). The semantics of the *Horizontal Passage*, *Room*, *Hall* and *Corridor* from *3DBO* associate with the *HU* and its subtype *HC* of the *INSM*. The *3DBO* supports paths with more specific semantics on horizontal spaces, such as the *Room*, *Hall* and *Corridor*, which have no counterparts

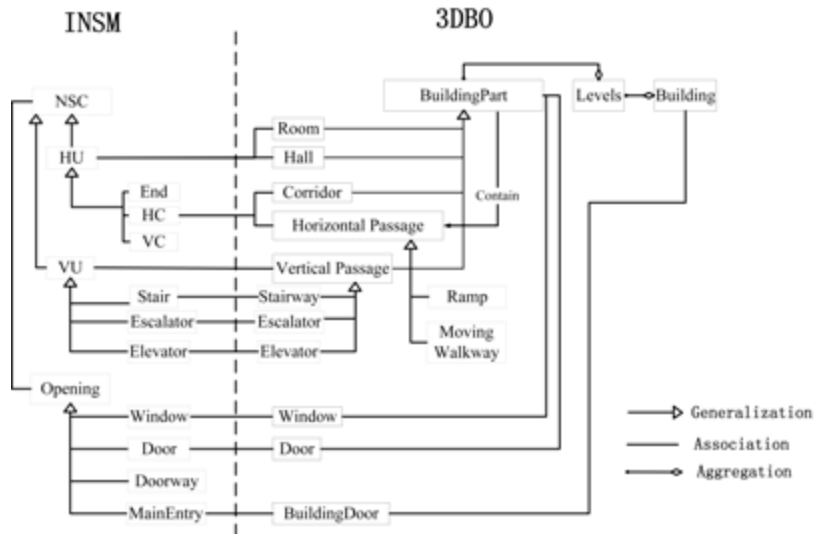

FIGURE 3.12 The associations of essential semantics of the INSM and the 3DBO.

within the INSM. However, I argue that INSM presents a more concise and efficient perspective of space semantics. As mentioned above, examples are *Hall* and *Room* to *HU*, and *Corridor* and *Horizontal Passage* to *HC* (see Figure 3.12). Too detailed distinction on spaces (e.g., in 3DBO) would not necessarily promote indoor routing. In such a case, INSM just focuses on the navigational functionality of space (i.e., *horizontal or vertical, Connector or End*).

§ 3.3 Logical and geometric networks based on INSM

As mentioned above, the INSM is designed to facilitate the extraction of logical and geometric networks from geometric building models. Two INSM classes, the *NU* and *OPN*, are related to nodes and edges of logical networks. The classes *NU* and *OPN* are also used to derive nodes of a geometric network, but in a different way. Besides network generation, the INSM is used to semantically enrich the logical network. This section elaborates on the way that the logical/geometric networks can be derived from INSM.

The classes *Node* and *Edge* with the stereotype *LogicalNetwork* represent nodes and edges of a logical network (see Figure 3.13). Within the logical network, each *NavigableUnit* (i.e., *NU*) is represented by a *Node*. The class *Edge* represents the connectivity between *NU*s (Figure 3.13). One *Edge* refers to one or more *Opening* (i.e., *OPN*). For example, two spaces are connected via three doors. This connectivity is reflected by an *Edge* of the logical network. Note, no matter how many doors are available between two spaces, the connectivity is always given by one edge. Thus, a logical network is constructed by extracting each *NU* with a node and each connectivity relationship via the connecting *OPNs* between two *NU*s.

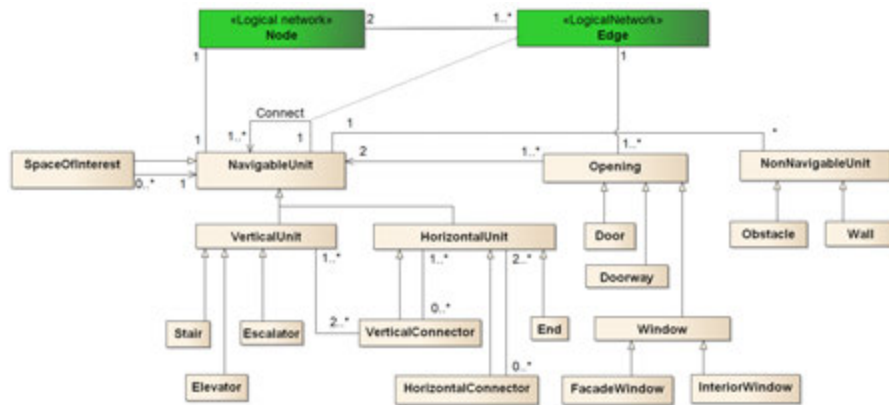

FIGURE 3.13 The UML model with classes on relationships between INSM and the logical network. The green part includes the classes representing a logical network's nodes and edges, while the pale pink part indicates INSM classes.

Figure 3.13 shows that *Nodes* can be specified with different INSM semantics (e.g., *VU* and *HU*). In this way, all *Nodes* can be tagged with the INSM semantics and then the logical network is the semantically enriched network.

Figure 3.14 presents the data model of the INSM and the logical network together with their class attributes. Subtypes (see the data type *SubtypeOfNavigableUnit*) of *NU* are stored in the attribute *Type*. Similarly, the classes *OPN* and *NonNU* store their subtypes in the attribute *Type*. The class *Edge* associates the class *Node* with the relationship *Start/End* (see Figure 3.14). Another attribute *Type* of the *Edge* is about the connectivity type of *Edge*, i.e., for indoor connections or between indoor and outdoor spaces.

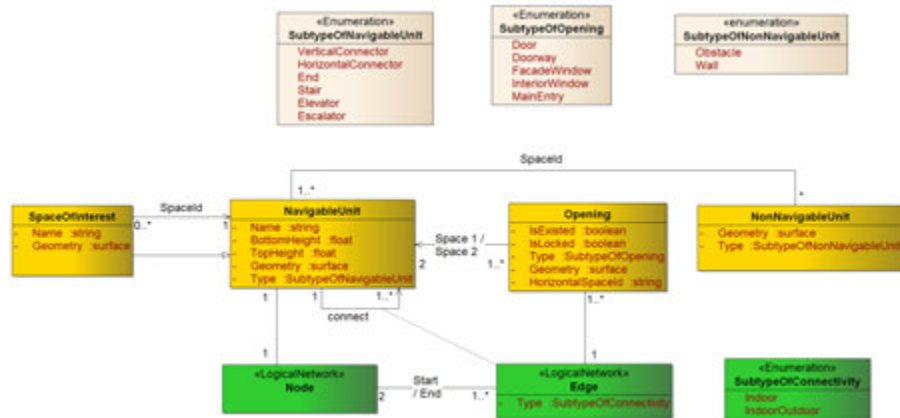

FIGURE 3.14 The UML model with classes and attributes on relationships between INSM and the logical network. The dark green part indicates the classes and a data type of the logical network; the yellow part represents the core INSM classes (NavigableUnit, Opening and NonNavigableUnit); the pale pink part represents three data types. The logical network (in dark green) can be derived from the NavigableUnit and Opening.

The class *Node* has an association to the related *NU*. Each *Node* instance corresponds to one *NU*.

The classes *NU* and *OPN* also correspond to nodes and edges of a geometric network. Figure 3.16 presents the UML model of a geometric network with attributes of the classes. Four classes (i.e., the light green part) are about the geometric network, i.e., *GeometricNode*, *GeometricEdge*, *OpeningNode*, and *PointOfInterest*. *GeometricNodes* and *GeometricEdges* form a geometric network. An instance of *GeometricNode* is represented by a point with coordinates of a location, while instances of *GeometricEdge* are indicated by a polyline representing the shortest path between two *GeometricNodes*. *GeometricNode* has two subclasses, i.e., *OpeningNode*, and *PointOfInterest*. The classes *OpeningNode* and *PointOfInterest* refer to nodes of a geometric network. *PointOfInterests* are specified to functional spaces derived from a subdivision [KZ14], such as the front area of a coffee machine in a hall. A user can specify *PointOfInterests* to any indoor location, even for doors and windows. To get a geometric path, a user also needs to specify two *OpeningNodes/PointOfInterests*, respectively, as her/his start and target locations.

An *OPN* associates with one *OpeningNode*, which means the *OpeningNode* represents the *OPN*'s reference location (e.g., the centre). A *GeometricNode* is an accessible location with coordinates, such as door/doorway centres and other *POIs*. A user can specify a preferred indoor location as a *GeometricNode* (i.e., *POI*). A *PointOfInterest* associates a *SpaceOfInterest* with a 1-to-1 relationship. In the association between the class *NU* and the class *SpaceOfInterest*, the multiplicity on the *SpaceOfInterest* side is from 0 to multiple (see Figure 3.15), which means the implicit association between *NU* and *PointOfInterest* has the same multiplicity. Thus, a *NU* may contain none or many *PointOfInterests*. In contrast, a *SpaceOfInterest* belongs to only one *NU*, which implies a *PointOfInterest* also belongs to only one *NU*.

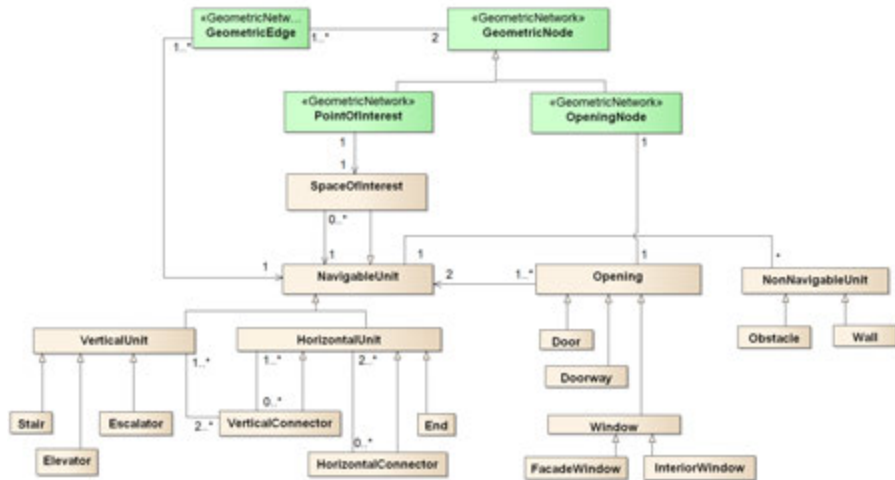

FIGURE 3.15 The UML model on relationships between INSM and the geometric network. The green part represents node classes (GeometricNode, PointOfInterest and OpeningNode) and edge class (GeometricEdge) of the geometric network. The pale pink part is INSM classes.

In the two-level approach, the geometric network does not have to be permanent. Different geometric networks can be derived in one building on demand. A geometric network can cover only one space, a group of spaces or all the spaces of a building. The *GeometricEdge* represents an accessible path between two *GeometricNodes* in the same space. Depending on the subtype of *GeometricNodes* (*OpeningNode* or *PointOfInterest*), a *GeometricEdge* may be from a door to another door, a *POI* to a door, a *POI* to another *POI*, and so on. In the association of the *NU* and the *GeometricEdge*, an *NU* contains 1 or multiple *GeometricEdges*. Conversely, a *GeometricEdge* belongs to only one *NU*.

A user in a *NU* needs to avoid *OBSs* (such as desks, chairs, etc.). A user's motion is restricted by her/his size. Given a user size, the space between some *OBSs* are not accessible and the *OBSs* need to be put in a group. The user needs to avoid the boundary of the group of *OBSs*. The self-association of the class *NonNU* refers to the obstacle-grouping operation (Figure 3.16). One *OBS* may be grouped with none or many other *OBSs*.

On the one hand, a number of *OBSs* (e.g., desks) can be grouped into a larger one due to the user size; on the other hand, a *NU* can be subdivided into smaller ones to better represent the functional meaning of the spaces. In both cases, a *GeometricEdge* reflects the accessible path avoiding the *OBSs* between two *GeometricNodes* of the same *NU*. A *GeometricEdge* is represented by a polyline. The *GeometricEdge* (i.e., the accessible path) between two *GeometricNodes* may be different for distinct user sizes.

Figure 3.16 presents the data model of a geometric network which contains classes' attributes. The geometric network is implemented by three classes (in light green), i.e., *GeometricEdge*, *OpeningNode*, and *PointOfInterest*. The *GeometricEdge*'s association *Space* refers to the space containing the *GeometricEdge*. The *Geometry* attribute stores

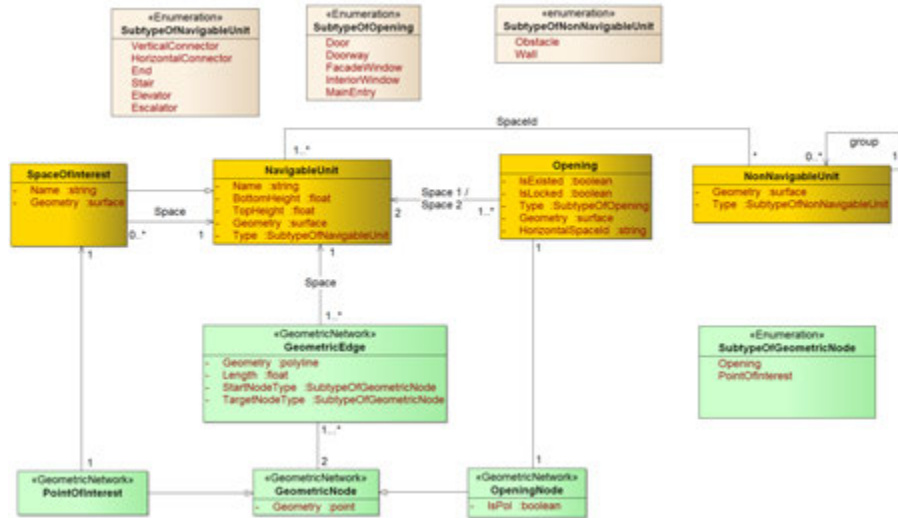

FIGURE 3.16 Data model with class attributes on relationships between INSM and the geometric network. The yellow boxes are the core INSM classes (the NavigableUnit, Opening and NonNavigableUnit); the pale pink boxes represent three data types; the green boxes are classes of nodes and edges of the geometric network.

a *GeometricEdge* as a polyline. Another attribute *Length* records the distance of a *GeometricEdge*.

For the association between the classes *GeometricEdge* and the *GeometricNode*, a *GeometricEdge* connects two *GeometricNodes*, and conversely a *GeometricNode* may connect 1 or more *GeometricEdges* (the multiplicity 1...* on the *GeometricEdge* side) (Figure 3.16). Two of *GeometricEdge*'s attributes *StartNodeType* and *TargetNodeType* indicate the type (*OpeningNode* or *PointOfInterest*) of a *GeometricEdge*-related node. Four combinations of the start node and the target node are given: 1) from an *OpeningNode* to a *PointOfInterest*; 2) from a *PointOfInterest* to an *OpeningNode*; 3) from an *OpeningNode* to an *OpeningNode*; and 4) from a *PointOfInterest* to a *PointOfInterest*.

The class *GeometricNode* has two subclasses *OpeningNode* and *PointOfInterest*, and its attribute *Geometry* contains the coordinates (see Figure 3.16). The *OpeningNode* has the attribute *IsPoI* which indicates whether the *OpeningNode* is a point of interest to a user for routing. As mentioned above, each *PointOfInterest* belongs to just one *NU*, reversely a *NU* may contain none or many *PointOfInterests*.

A UML class diagram is used to arrange the classes of INSM, the logical network, and the geometric network in Figure 3.17. The key classes of the INSM are the *NU* and *OPN*. As mentioned before, the *NU* and *OPN* are associated to the classes that represent nodes and edges of the logical (in dark green) and geometric (in light green) networks.

Figure 3.17 presents the relationships among classes of the logical and the geometric networks. Nodes of the logical network refer to *NU* instances, and edges represent the connectivity of *NU*s. Nodes of the geometric network correspond to locations. An *Edge*

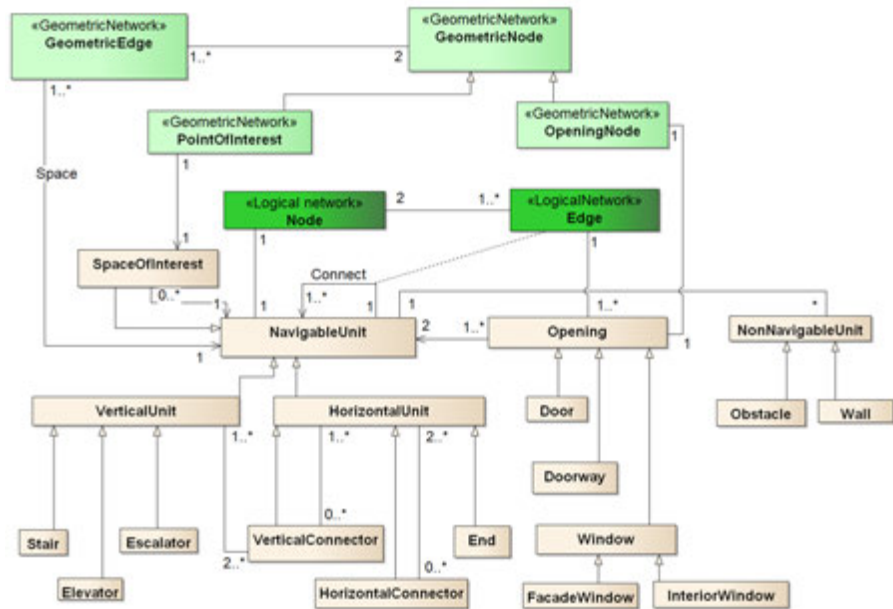

FIGURE 3.17 The relationships between the INSM and the logical/geometric network. The light green part represents nodes and edges of the logical network, and the dark green part stands for the classes of nodes and edges of the geometric network.

instance represents the connection of two *NU*s, which involves one or more *Opening* instances and thus corresponds to one or more *OpeningNodes* due to the 1-to-1 association between *Opening* and *OpeningNode* (Figure 3.17). A logical node (the class *Node*) contains none or more *PointOfInterest* instances, since each *Node* associates with one *NU*. The class *GeometricEdge* refers to a detailed path represented by a polyline and contained in a *NU*.

Generally, the logical and the geometric network focus on different levels of details; they are two ways of abstraction for one building. The logical network contains the semantics and connectivity of a building, while the geometric network is derived from the geometry of a building. *Nodes* of the logical and the geometric network refer to different spaces (e.g., *NU*s and *Doors*), thus logical nodes cannot be reused by the geometric network. Specifically, logical nodes are conceptual and geometric nodes are physical.

§ 3.4 Routing options

The previous sections have introduced *INSM* and its relationships with the logical and geometric networks. Both logical and geometric networks are used to provide routing. This section explains how they can be used individually or together. As will be shown later, one logical path can link to different geometric paths. Normally indoor path com-

putation provides one 'optimal' geometric path, but here geometric paths are computed on demand according to different conditions.

The combination of logical and geometric networks is very flexible and allows a variety of user-specific paths to be computed. Some users may be satisfied with a rough description of the path, which can be provided by using only the logical network. For instance, if a user only needs to know the names of the spaces to be passed (e.g., corridor and stairs) for orientation, then the path is represented by a logical path. If a user needs a more detailed path which shows how obstacles have to be avoided and which doors have to be used, then a geometric path is computed. Moreover, the two-level routing approach computes both logical and geometric paths when a user provides her/his preferences on spaces and geometric locations.

The following sub-subsections introduce routing options which indicate a user's needs (e.g., visiting some SOIs and/or POIs in order) and the resulting path(s) for the user. As routing can be conducted in the logical and the geometric networks independently, this section presents the separate routing options for the two types of network. In addition, the semantics in the logical network and the geometry in the geometric network can be combined to increase the flexibility for routing. For example, routing results for the logical network can exclude unrelated spaces and then derive geometric paths more efficiently. Thus, seven routing options based on combinations of the two networks are introduced in this section.

To sum up, three categories of routing options can be identified according to a user's needs: 1) only the logical network is used to compute logical paths for users; 2) only the geometric network is used to compute geometric paths for users; and 3) both the logical and geometric networks are adopted for routing (i.e., the two-level routing), and a user obtains logical and geometric paths. The next part elaborates these routing options and presents examples of them.

§ 3.4.1 Routing using the logical network

This section introduces routing options only with a logical network. In such cases, a user can find the way through spaces without geometric information. In other words, the user asks for only logical paths instead of geometric paths since the space sequences reflected by the logical paths are enough for her/him to follow. Commonly a user has no understanding about spaces' semantics, but she/he can perceive the name of spaces. Thus, a user receives paths based on the names of the spaces to be visited. For example, a logical path is presented to a user as the following description: 'I am in *Office 260*, I will pass by *left corridor*, follow down *stair 1*, and arrive at *entrance hall*'. In this description, the logical path consists of the spaces *Office 260*, *left corridor*, *stair 1*, and *entrance hall*. The logical path can be presented textually or graphically with highlighted spaces on a digital map or in a building model. In this thesis, the second approach is used.

To compute a logical path, a user needs to specify the start and target spaces. She/he can also specify some intermediate spaces (i.e., SOIs) to be visited between the start and target ones. The computed path would cross through the given SOIs in a given order. The following routing options are denoted with the prefix 'L' which means 'Logical Path'.

L1.1 A user provides NO SOI. The user receives one logical path visualized as high-lighted spaces on a digital map. The user specifies the start and the target space and requests a logical path. For example, the user is in the visitor reception (the start space) of a building and he wants to go to the conference centre (the target space). Then the user obtains a logical path referring to the names of the intermediate spaces from the visitor reception to the conference centre. Note that there may be multiple logical paths between two spaces. In such cases, the routing system would present the 'best' one (e.g., with the minimum number of spaces) for the user as the final path, which will be introduced in Chapter 4.

L1.2 A user provides SOIs to be visited and their ordering¹. The user gets one logical path through the given SOIs.

The user specifies a set of spaces and their order to be passed, and then asks for a logical path to cross through the given spaces. For example, the user is in a corridor of a faculty (the start space), and she/he wants to go to the lecture *room Z* (the target space). Before arriving at *room Z*, she/he would like to drop by the faculty's *library* (i.e., a SOI). Then the user gets a logical path which crosses the *library* to *room Z*. The resulting logical path traverses the *library* and *room Z* sequentially.

Option L1.1 and option L1.2 are applied to different scenarios. Option L1.1 generates logical paths automatically for a user according to a specified criterion (e.g., the fewest spaces to be visited). The selection criteria of logical paths will be elaborated in Chapter 4. While option L1.2 applies for the users who have specific needs (e.g., visiting SOIs sequentially), and the users can add any number of SOIs in between the start and target spaces. In the example of option L1.2, the user can add more SOIs between the *library* and *room Z*. Actually L1.1 is the special case of L1.2 where the POI number is 0.

§ 3.4.2 Routing using the geometric network

Both the geometric and the logical networks can represent all the indoor spaces, some of the spaces, or only one space of a building. Based on a complete (all spaces) or partial geometric network (one or some spaces), geometric paths between two *GeometricNodes* are computed. The *GeometricNodes* lie in one space or different spaces. In one space, the path between two *GeometricNodes* is computed in the geometric network of the space. In the complete geometric network, a path can be computed between any two *GeometricNodes*. A geometric network can be created in selected spaces, and the geometric network can be built 'on the fly'. This section presents the routing options using just the geometric network. These options can be applied to either complete or partial geometric networks. In all the cases, a user needs to specify the start and target locations to get a geometric path. Also, she/he can set some POIs where the computed path needs to cross orderly. The following routing options are denoted with the prefix 'G' which means 'Geometric Path'.

G2.1 A user provides NO POI and one size of the user. The user receives one geometric path, which is visualized on a digital map.

1 POIs not ordered are out of the discussion in this thesis.

Given the start and target locations, a user gets a complete geometric path. For example, the user is at the main entrance of a skyscraper which indicates the coordinates of the user. She/he wants to go to a clothing store in this building, and the target location is denoted by the coordinates of the store's entrance. A geometric path (e.g., the shortest path) between the main entrance and the store's entrance is computed.

G2.2 A user provides POIs and their ordering², and one size of the user. The user gets a geometric path through the given POIs sequentially.

This option offers users the possibility to specify POIs. A digital map is provided to a user to select POIs. As mentioned before, POIs refer to the coordinates related to the spaces which the user would visit (e.g., shops, coffee corners, toilets, benches, shelves, counters, etc.). The map contains POIs as the coordinates of the points close to or at these spaces. For example, a user at a hospital walks to the *reception desk* to make an appointment, then goes to a *waiting section*. After the user sees a doctor, the doctor tells the user to pass by the *inquiry point* on the same floor. Following the corridor, the user would make a right turn at the *corridor's end* to the *pharmacy counter* to pick up medicine. In this example, the user specifies POIs related to the *reception desk*, the *waiting section*, the *inquiry point*, the *corridor's end* and the *pharmacy counter*. The POIs are depicted by a point in the functional space close to the *reception desk*, a point inside the *waiting section*, a point close to the *inquiry point*, a point at the *corridor's end*, and that at the front of the *pharmacy counter*. A geometric path is computed to cross through these POIs sequentially.

G2.3 A user provides POIs with their order and different sizes of the user. The user gets a geometric path consisting of several parts. Each part is suitable for one of the given sizes.

This option enables the routing that provides paths according to a user size that is the diameter of the circumcircle covering the user and her/his operated objects. For example, in an airport a member of staff steps out of the office and walks to a cart-collection location, picks up a wheeled cart and transports goods with the cart to a port. The POIs are the *office*, *cart-collection location* and the *port*. From the *office* to the *cart-collection location*, the size is the staff's dimension. While the user size changed when the staff picked the cart, i.e., the size is determined by the shape of the person with the cart, then the person needs to know the accurate path for the new size from the *cart-collection location* to the *port*. The geometric path consists of the path from the *office* to the *cart-collection location*, and the one from the *cart-collection location* to the *port*.

Option G2.1 is used to compute a geometric path between two locations for a given user. The two locations can be inside one space or in different spaces. In such a case, the user does not specify any POI and the resulting geometric path is suitable for the user size. Similar to the option L1.2 on a logical network, option G2.2 allows the user to specify a set of POIs to be visited and the order of these POIs. A geometric path is computed to pass through all the POIs in sequence according to the given user size.

The user size in the option G2.1 is considered constant. In contrast, the option G2.3 considers changes of a user size. Figure 3.18 provides the geometric paths for two dif-

² POIs not ordered are not considered in this thesis. Also see footnote 1.

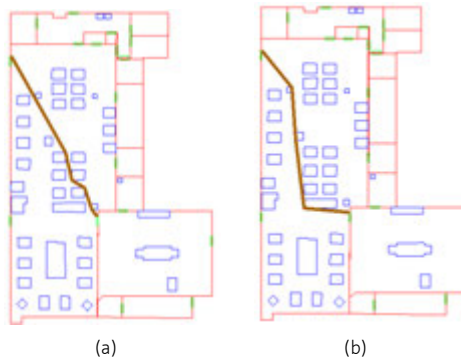

FIGURE 3.18 Paths for the user sizes of 0.4 m and 0.6 m on a floor plan. (a) A geometric path for the 0.4 m size; and (b) A geometric path for the 0.6 m size.

ferent user sizes in a floor plan. Figure 3.18a and b illustrate the geometric paths for the sizes 0.4 and 0.6 meter (m), respectively. The routing for geometric networks with different user sizes will be elaborated in Chapter 5.

In this research, a user needs to specify POI when changing sizes of the user are considered for routing. The POI is the location where the user size changes (e.g., the location where the user size increases because of picking a large tool).

Table 3.1 lists the routing options of the first and the second categories, which indicates whether each routing option includes POIs/SOIs and presents the number of user sizes assumed in each routing option. *Network* indicates the targeted network. *Need SOI/POI?* indicates whether a user needs to specify SOIs/POIs. *Adopted user sizes* refers to the number of user sizes.

TABLE 3.1 The comparison of user needs between the first and the second categories of routing options.

Option	Network	Need ordered SOI/POI?	Assumed user sizes
L1.1	Logical	No	None
L1.2	Logical	Yes	None
G2.1	Geometric	No	One
G2.2	Geometric	Yes	One
G2.3	Geometric	Yes	Multiple

§ 3.4.3 Routing using both networks

The previous two sections have explained the routing options using exclusively a logical or geometric network, while this section focuses on the combined use of the logical and geometric networks, which enables the routing computation to fulfil user needs on both of the networks. For example, a user specifies a SOI and a POI inside a building and she/he wants to get an accurate path. By routing for a logical network the user

obtains a logical path through the SOI, and then a partial geometric network is built 'on the fly' based on the logical path. Finally, the user either obtains an accessible geometric path which crosses through her/his POI, or receives a 'No Path' message.

It is necessary to further emphasize the distinction between SOIs and POIs for the routing options in this third category. A user can specify a space as SOI by its name (e.g., room 301). Thus, a SOI corresponds to a node of the logical network. As explained before, one space (e.g., SOI) can contain multiple POIs as points. SOIs are used for routing on logical networks and POIs for routing on geometric networks.

Seven options are proposed for the two-level routing. For clarity, these options are illustrated in a floor plan of *Schiphol Airport, Netherlands*. Logical networks are not shown here. Logical paths are visualized by highlighting the related spaces that need to be visited. Arrows indicate the visiting order for a user. For all cases, the user needs to specify the start and target spaces and/or locations. Optionally the user can specify: 1) SOIs and/or POIs; and 2) the order that SOIs/POIs need to be visited; and 3) the user size(s).

To clearly show the combinations of routing options of the first and the second categories, the following routing options are denoted with the prefix 'C' which means 'Combination'. The seven options are presented below:

C3.1 A user provides NO SOIs and POIs, and a constant user size. The user receives one logical path and one geometric path, which are visualized on a digital map.

This option makes use of options L1.1 and G2.1. Option L1.1 can result in several logical paths depending on the path computation criterion. From these only one path is selected (Figure 3.19b), a geometric network is built in the spaces indicated by the logical path (Figure 3.19c). A geometric path (e.g., the shortest path) is computed for the user (Figure 3.19d).

There is no accessible geometric path when one of the spaces is completely obstructed by obstacles. In this case, the user would get a message about no paths and she/he can decide to compute an alternative path. In the subsequent routing options, this 'no path' case is treated in the same way.

C3.2 A user provides NO SOIs but specifies ORDERED POIs, and a constant user size. The user receives one logical path and she/he gets a geometric path through the POIs sequentially.

This option makes use of options L1.1 and G2.2. Option L1.1 provides one logical path to the user to indicate POIs (e.g., two POIs in two spaces in Figure 3.20a). The geometric path is computed through the POIs (Figure 3.20d).

Example: A student at the front door of a faculty building wants to visit a teacher's *office 080*. According to the computed logical path the student needs to cross *corridor L*, *staircase 3*, *passage T* on another floor and then go to the *office 080*. The student knows there is an *inquiry desk* in *corridor L*, and she/he wants to go there and pick some brochure. Thus, the student adds the point in front of the *inquiry desk* as a POI, and then receives a detailed path through the POI and in the above spaces.



(a)



(b)

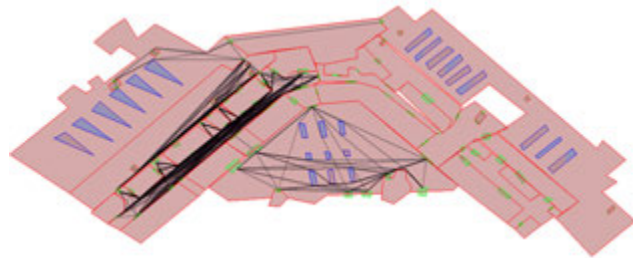

(c)



(d)

FIGURE 3.19 Illustration of option C3.1. (a) The start (in light purple) and target spaces (in light yellow); (b) A logical path (in green) is represented by a sequence of spaces, and arrows indicate the movement direction; (c) The geometric network in the spaces. Doors are nodes and black lines are edges; and (d) The geometric path.

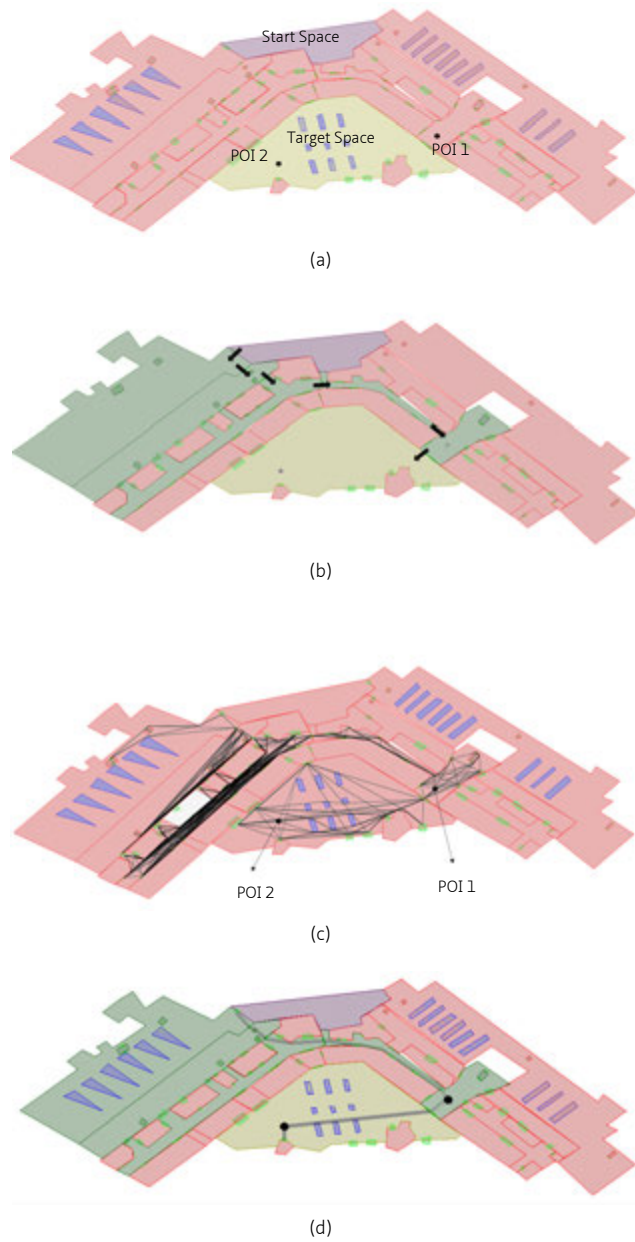

FIGURE 3.20 Illustration of option C3.2. (a) The start and target spaces. The black points are two ordered POIs; (b) The logical path; (c) The geometric network in these spaces of the logical path; and (d) The geometric path through the POIs.

C3.3 A user provides ORDERED SOIs and POIs, and different user sizes (regarding specific SOI/POI). The users get one logical path through the SOIs and one geometric path for different sizes.

This option makes use of options L1.2 and G2.3. A user first gives the SOIs where the user's size would change (Figure 3.21a). Then option L1.2 results in one logical path through the SOIs in order (Figure 3.21b). The user gets the names of the spaces to go through. Then in a digital map she/he specifies the POIs (the black point in Figure 3.21c) when the size changes. The geometric network is built in the spaces of the logical path. The resulting geometric path consists of several parts. These parts correspond to different sizes (e.g., the thin and thick lines in Figure 3.21d).

Example: As mentioned before, the staff in the airport wants to go to the *cart-collection* site and pick a cart (user size change), and then to the *port* to distribute goods. She/he would get one detailed path for both the initial size and the altered size.

C3.4 A user provides ORDERED SOIs and POIs, and a constant user size. The user gets one logical path through the SOIs and several separate geometric paths in these different SOIs.

This option makes use of Options L1.2 and G2.1. The user specifies the SOIs (e.g., the cyan space in Figure 3.22a) where she/he needs an accurate path. A logical path is computed through the SOIs (Figure 3.22b). Geometric networks are built separately in these SOIs (Figure 3.22c). The user provides POIs in each of the SOIs. Then option G2.1 is used to find a geometric path in each SOI (Figure 3.22d).

Example: A user in an airport knows the names of the spaces to go to. She/he also knows how to walk through most of the spaces. But in the large *arrival hall* (the SOI), the user needs details to confirm her/his direction. The user adds the opening between the *lounge hall* and the *arrival hall* as a POI, and specifies the *arrival hall's* exit as another POI. A geometric path is computed in the SOI between the two POIs.

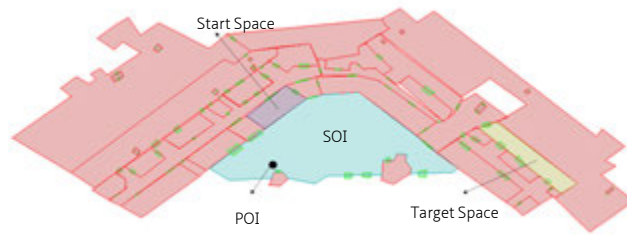

(a)



(b)

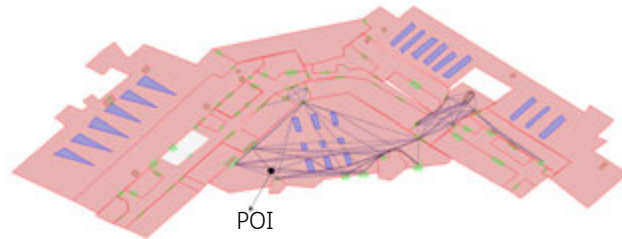

(c)

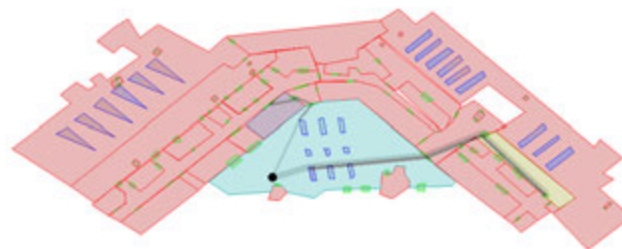

(d)

FIGURE 3.21 Illustration of option C3.3. (a) The start and target spaces, and the specified SOI (in cyan) and POI (where the user changes size); (b) A logical path indicated with arrows; (c) The resulting geometric network; and (d) The geometric path. The thin lines are for the initial size, and the thick lines for the altered size.

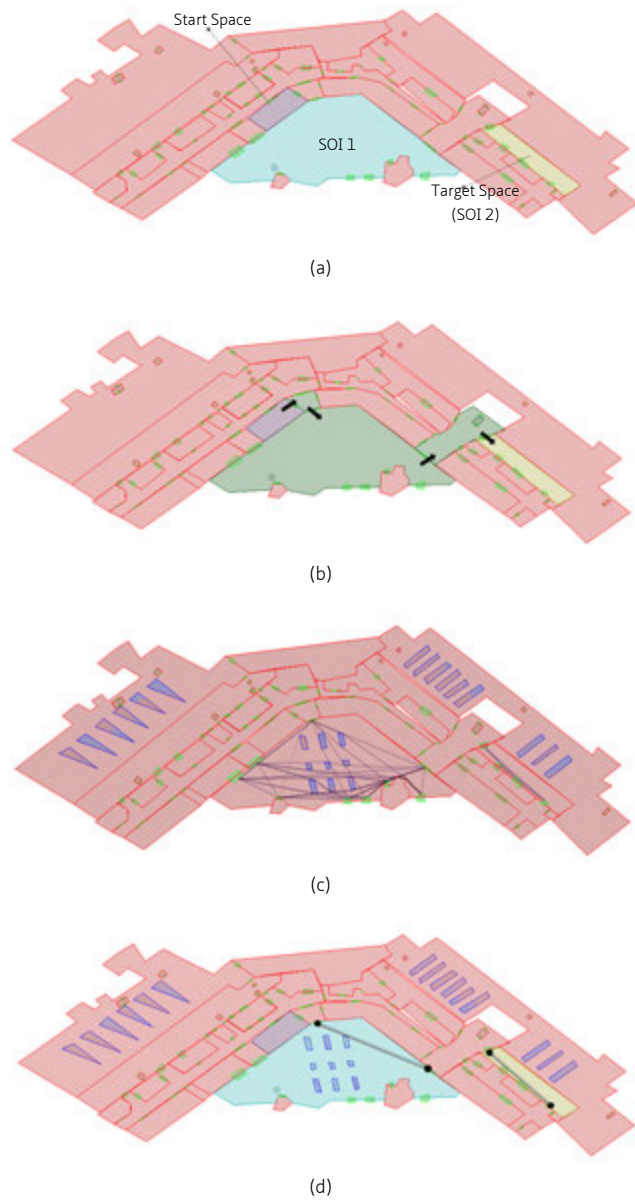

FIGURE 3.22 Illustration of option C3.4. (a) The start and target spaces. Except the presented SOI, the target space is also specified as a SOI; (b) The logical path through the SOIs; (c) Two separate geometric subnetworks in the SOI and the target space; and (d) Doors as POIs in the SOI and the target space, and related geometric paths.

C3.5 A user provides ORDERED SOIs but NO POIs, and a constant user size. The user gets one logical path through the SOIs and one geometric path.

This option makes use of Options L1.2 and G2.1. A logical path is computed through the SOIs in order (Figure 3.23b). The geometric network is built in the spaces of the logical path (Figure 3.23c), and a geometric path (*i.e.*, the shortest path) is computed (Figure 3.23d).

Example: A visitor at a skyscraper wants to visit several places (*a clothing shop, a barbershop, a coffee house and a restaurant*) in the given order. Similar to the cases above, a logical path through these places shows the user how to visit all the spaces sequentially (Figure 3.23b). The geometric path gives the user details for walking in these spaces (Figure 3.23d).

C3.6 A user provides ORDERED SOIs and POIs, and a constant user size. The user gets one logical path through the SOIs and one geometric path through the POIs.

This option makes use of Options L1.2 and G2.2. A user is orientated with some important spaces (SOIs) (*e.g.*, the cyan spaces in Figure 3.24a) and locations (POIs) in them (*e.g.*, the black dots in Figure 3.24b). A logical path is computed through the SOIs (see Figure 3.24b). The geometric network is built in the spaces on the logical path (see Figure 3.24c). Then a geometric path is computed to pass through the POIs (see Figure 3.24d).

Example: In an airport, the user walks first to the *departure hall* and finds an *inquiry desk*. Then she/he needs to find a *check-in desk* in the *departure hall*. Afterwards, the user goes to another floor, and enters the *inspection section* to pass a *security gate*. Finally, the user arrives at the *departure lounge*. The *departure hall*, the *inspection section* and the *departure lounge* are the SOIs, while the *inquiry desk*, the *check-in desk*, and the *security gate* are the POIs. In such a case, the user not only gives the SOIs, but also specifies the POIs to go inside the SOIs.

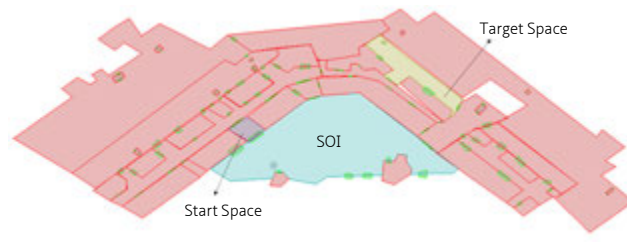

(a)



(b)

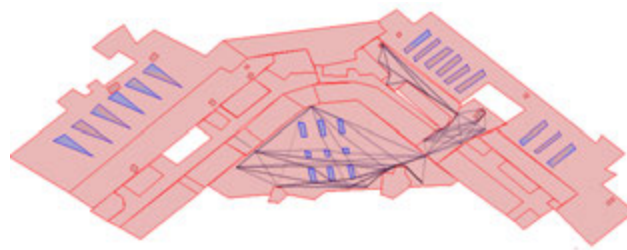

(c)



(d)

FIGURE 3.23 Illustration of option C3.5. (a) The start and target spaces, and the SOI; (b) The logical path through the SOI; (c) The geometric network in the spaces of the logical path; and (d) The geometric path.

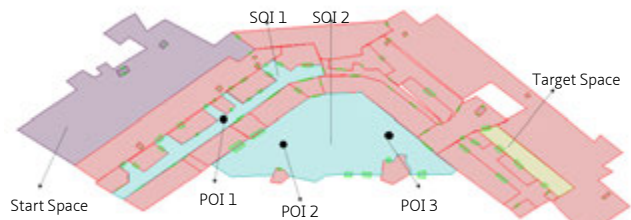

(a)



(b)

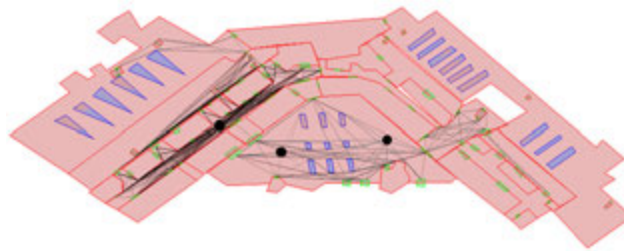

(c)



(d)

FIGURE 3.24 Illustration of option C3.6. (a) The start and target spaces. The two cyan spaces are the ordered SOIs; (b) The logical path through these SOIs orderly; (c) The geometric network in the spaces of the logical path; and (d) The geometric path through the three POIs in order.

C3.7 A user provides ORDERED SOIs but NO POIs, and a constant user size. Based on a computed geometric path and its related logical path, the user does not approve or is not allowed to pass through one or more spaces (named *Anti-SOI*). Then she/he specifies SOIs and gets one logical path and one geometric path.

This option makes use of Options G2.1 and L1.2. The user first obtains a geometric path between the start and target locations (see Figure 3.25a) from the routing on the complete geometric network of a building. If the user does not satisfy the geometric path due to some spaces crossed by the geometric path, she/he can specify SOIs (see Figure 3.25c) and get a corresponding logical path (see Figure 3.25d). Then a geometric network is built in the spaces on the logical path (Figure 3.25e). The related geometric path is computed for the user (see Figure 3.25f).

Example: In a skyscraper the user gets a geometric path from *office 1010* to the *entrance hall* on the ground floor, but the user is not satisfied with the space *stair K* crossed by the geometric path. With a smart phone visualizing the logical network of the skyscraper, the user manually adds the space *elevator L* as a SOI and gets the logical path through the *elevator L*. Then the new geometric path is computed for the user.



(a)



(b)

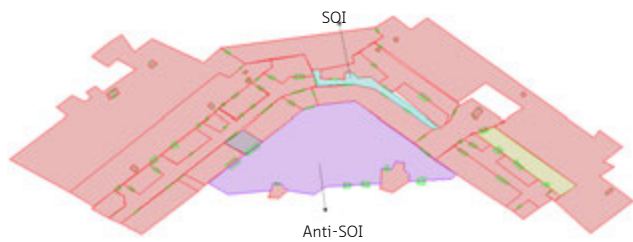

(c)



(d)

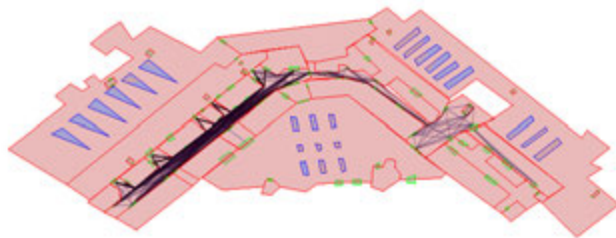

(e)



(f)

FIGURE 3.25 Illustration of option C3.7. (a) A computed geometric path for a user; (b) The corresponding logical path of the geometric path; (c) Anti-SOI (in purple) of the user, and the SOI (in cyan) for new computation; (d) A new logical path through the SOI; (e) The geometric network in the spaces of the new logical path; and (f) The final geometric path.

In the options from C3.1 to C3.6, a routing option is applied first on the logical network and then another routing option on the geometric network. In this way, only a partial geometric network of a building is needed for routing. The partial network is bound to the computed logical path (e.g., built in the spaces on the logical path) and a user's decision (e.g., option C3.4, built only in the user specified spaces). The partial network may not result in a path, which can be supplemented by re-routing. In contrast, option C3.7 applies first option G2.1 on a complete geometric network of a building, then computes a user-preferred logical path on the logical network. Option C3.7 is a special case that allows a user to adjust geometric paths on demand.

Without SOIs, option C3.1 can provide a geometric path through all the spaces on a logical path. A user can also decide to compute geometric paths in only a part of the spaces (i.e., option C3.4). Option C3.4 and C3.5 both use options L1.2 and G2.1. In the two options, a user gets a logical path through the selected SOIs. In option C3.4 the user obtains geometric paths only in the SOIs, but option C3.5 provides a geometric path through all the spaces on the logical path. This is the main difference between option C3.4 and option C3.5.

TABLE 3.2 Comparison of user needs of the routing options in the third category, including specifying POI or SOI (*Need ordered SOI?* and *Need ordered POI?*) and the number of user sizes (*Adopted user sizes*).

Option	Combined options	Need ordered SOI?	Need ordered POI?	Adopted user sizes	Resulting continuous geometric path
C3.1	L1.1 + G2.1	No	No	One	Yes
C3.2	L1.1 + G2.2	No	Yes	One	Yes
C3.3	L1.2 + G2.3	Yes	Yes	Multiple	Yes
C3.4	L1.2 + G2.1	Yes	Yes	One	No
C3.5	L1.2 + G2.1	Yes	No	One	Yes
C3.6	L1.2 + G2.2	Yes	Yes	One	Yes
C3.7	G2.1 + L1.2	Yes	No	One	Yes

Table 3.2 compares user needs of all the above options, including specifying POI or SOI and the number of user sizes. Option C3.1 does not need SOIs and POIs, while the other options take user intervention on SOIs and/or POIs. Considering the influence of a user size on routing, option C3.3 provides paths in terms of changes of the user size during a motion (the value 'multiple'). The other options all consider one user size only.

These routing options are applied to different situations where indoor paths are not unique. A user's preferences (the size and preferred SOIs/POIs) result in the suitable path(s). Table 3.2 is not an exclusive list of the routing options using both logical and geometric networks. Given other application scenarios, more options can be proposed based on the combination of routings on both logical and geometric networks. For example, a new option can be devised by changing the option C3.2, where multiple user sizes could be adopted.

§ 3.5 Summary

This chapter responded to and explained the following research sub-questions in Chapter 1:

2. *What data and navigation model is appropriate to represent the semantics, topology and geometry of indoor spaces?*
3. *What kind of user-related paths can be computed with the semantics, topology and geometry of indoor spaces?*

For question 1, though *IndoorGML* provides a description of specific semantics, topology and geometry of indoor spaces, it does not aim to generate navigation networks. Therefore, in this chapter *INSM* is proposed. The *INSM* semantics can be projected onto both simple and complex buildings with different subdivisions, which can facilitate the generation of navigation networks. Semantics in *INSM*, such as *NavigableUnit (NU)*, *VerticalUnit (VU)*, *HorizontalUnit (HU)*, *Opening (OPN)* and *Obstacle (OBS)*, are proposed according to the navigational functionality of indoor spaces. Basic measures of space such as *Name*, *Bottom Height*, and *Top Height* are designed for related classes in *INSM*. Connectivity of spaces (topology) is explicitly stored in *INSM*, which can derive logical networks automatically. Building geometry is stored in *INSM* and it can be directly used for the creation of geometric networks. In this thesis, the geometry of indoor space is represented by 2D/3D surfaces, such as 2D surfaces for *HU* and 3D surfaces for *VU*.

Regarding question 2, the two-level routing approach is proposed which adopts two types of navigation model, *i.e.*, the logical and geometric networks. The user-related paths are defined by a user's motion ability, size and space/location preferences *etc.* Based on the two types of network, the two-level routing approach aims to provide customized paths for a user when the user specifies her/his preferences on indoor spaces and/or locations. *INSM* is used to facilitate the derivation of the logical and the geometric networks (see Section 3.3). The logical network should be suitable for a user's motion ability (*e.g.*, wheelchair users). The two-level routing approach integrates routing on both the logical and the geometric network and seven routing options are designed for different applications (see Section 3.4). These routing options allow indoor routing to be flexibly computed according to user needs such as passing through ordered SOIs/POIs and obstacle-avoidance. The resulting geometric paths are always accessible to users with the given size. Note that the seven options are not an exhaustive list of the two-level routing, and it is possible to devise more options for other user-related applications. For example, a user specifies SOIs and POIs which are not ordered. In this case, the two-level routing may provide a group of geometric paths for the user.

This chapter has also introduced the other two categories of routing options (see Section 3.4). Two routing options are based on using just the logical network and three options based on using just the geometric network, respectively. This chapter has not mentioned yet the implantation of all these routing options, which will be introduced in chapters 6 and 7.

Regarding the possible 'NO Path' case in the two-level routing, the user would be informed by a message about no paths, and the user can request an alternative path. First, a new logical path is computed for the user, and then the corresponding geometric path is also provided on demand. In addition, a user may get multiple logical/geometric paths from the two-level routing. In this case, the routing system would pick one of the 'optimal' paths for the user, which can reduce the user affordance for using the system.

The subsequent chapters will further explain details of the proposed routing options. Chapter 4 will introduce routing criteria regarding space semantics and human wayfinding behaviours, and elaborate the routing computation on the logical network (*i.e.*, on the abstract level). Chapter 5 will present the routing computation on the geometric network (*i.e.*, on the detailed level), which makes it possible to compute accessible geometric paths according to a given user size. Chapter 6 will present a realization of one-level routing, *i.e.*, routing on just the logical or the geometric network. Chapter 7 will present realization of the two-level routing.

4 Routing on logical networks

The previous chapter introduced the two-level routing approach which follows a *Coarse-to-Fine* routing manner. Logical paths are computed on the logical network (*i.e.*, on the abstract level), which provides a general picture about motions passing through indoor spaces. Such paths are conceptual to pedestrians without geometric details. In some cases, given a start and a target space, there are multiple logical paths for a user. For example, a visitor at the main hall of a building can take either of two elevators/stairs to arrive at the same office on the top floor, which corresponds to different logical paths. Therefore, it is necessary to compute qualified logical paths according to user demands on space.

This chapter presents criteria for routing on the logical network, and introduces the routing procedure. Section 4.1 shows the purposes of routing on the logical network. Section 4.2 presents the process of logical network derivation from the INSM. Inspired by human wayfinding behaviours, three existing strategies are adopted and six routing criteria are proposed to simulate the wayfinding results of pedestrians (Section 4.3). The criteria involve different constraints on an indoor path, such as minimizing the NavigableUnit (NU), HorizontalConnector (HC) or VerticalUnit (VU). These criteria are defined on the *INSM* semantics and their meanings are given in Section 4.3. Section 4.4 presents the concrete steps of routing with a single criterion, and with multiple ordered criteria. With a single criterion, the logical network is weighted according to the semantics of logical nodes and then routing is conducted by using the *Dijkstra* algorithm [Dij59]. In addition, routing with the ordered multiple criteria can reduce the number of logical paths between two spaces. This chapter, which closes with a short summary (Section 4.5), is related to the following author's own publications: [LZ13a].

§ 4.1 Motivation

Two distinct users (*e.g.*, pedestrians and wheelchair users) obtain different subdivision results for the same building [BNK09]. As a logical network is derived from the building's subdivision result, the two users will navigate in different logical networks. For a given building, the user's locomotion type [KK12] and other constraints on spaces (*e.g.*, access permission) can be used to determine spaces which a user can locate and navigate to [BNZK13]. Accordingly, the two users would get different paths under the same routing criterion (*e.g.*, the minimum number of spaces to be passed). In addition, a user may have a specific preference on indoor paths with respect to a given scenario. For example, a path from the entrance hall to an office on the fifth floor in a building can be with or without the use of the elevator.

The semantics of spaces is useful for the description of paths. Pedestrians cannot precisely perceive a detailed geometric path by metric instructions. Precise distances (*e.g.*, 40 or 45 meters) can be measurable for robots, but the subtle difference between the distances cannot be distinguished very well by pedestrians. Thus, metric instructions, such as 'Turn sharp right, walk for 9 metres and reach the north stairs' [RZC14], should be replaced by other semantic descriptions. For instance, Rehl (2007) has applied semantic instructions to provide references to the semantics of indoor environments,

such as 'Walk to the end of the corridor, meet at the bottom of the stairs, and walk up the stairs' [RGL⁺07]. Here the corridor and the stairs are semantics of indoor spaces.

A pedestrian's preference for specific spaces can be reflected with semantics. For example, one needs a path to pass through the minimum number of corridors. In this case, the user preference for space is described by the number and the semantics of spaces. Similarly, a pedestrian prefers to pass through the minimum number of ordinary spaces to a destination, when a large building is subdivided into spaces with a similar size. This user has no specific need for space semantics but she/he expects the resulting path would be a short route.

In this research a user is asked to provide a similar preference description. All preferences collected from the user are sorted in a priority order. For instance, two ordered preferences are 'the minimum number of passed spaces' and 'to minimize the use of elevators'. Following the first preference, 'the minimum number of spaces', it could happen that the path crosses a stair or that there are several possible paths. Then the second preference is considered and the user is provided with a path via an elevator, which however can consist of more spaces than other path choices (without an elevator). Therefore, routing with pedestrian preferences does not ensure the shortest path.

Logical networks are often used to give an abstract representation of a building [ICC12] and support the generation of human-readable descriptions about moving through the building. According to the wayfinding theory, there are three types of knowledge supporting a person's cognitive maps, *i.e.*, *survey*, *path*, and *landmark* knowledge [SW75, TG83]. Survey knowledge is the understanding of the topological structure of an environment. Path knowledge is about the method of finding the way from a start to a destination via many intermediate locations. Landmark knowledge means finding the way with locations with high salience. 'Landmark' means the distinctive objects in a navigation environment such as high-rise buildings. Compared to survey knowledge (*e.g.*, overview of indoor maps) about a building, path knowledge (*e.g.*, steps to find a destination) better serves a user for indoor wayfinding [THR82]. Commonly, humans describe paths to each other using a logical path. For example: 'from the entrance hall on the ground floor, go up the stair to the second floor, turn left, and go to the end of the corridor'. In this example, the logical path is represented by the sequence of the entrance hall, the stair and the corridor. Also, landmark knowledge helps the user to orient and better follow the described path. Landmarks can help pedestrians to be aware of the route being followed [FLZS12]. Salient spaces acting as landmarks in a walking environment can also support users' orientation. For example, the entrance hall of a building is a salient space. A user can always step back to the hall whenever she/he gets lost in the building, and restart the walking from there.

As mentioned in Chapter 2, wayfinding is a kind of self-guidance to target locations with the help of tools (*e.g.*, signage) [SKO97], which can be considered a heuristic process. Hölischer *et al.* [HB07] mention three strategies of pedestrian wayfinding behaviour that aims to simplify the heuristic as much as possible: 1) pedestrians approach the destination by following the same floor as much as possible and then taking the closest stairs to the destination; 2) pedestrians arrive first at the floor of the destination as directly as possible, and then go horizontally to the destination; and 3) pedestrians always pass high-salience indoor areas. It is argued that the three strategies can reduce the memory load on users during wayfinding. If one computes such a path for users, *i.e.*, the users are aware of the spaces to be passed and the sequence of

the spaces, they can find the desired space by following only signage or verbal instructions (if available).

To simulate such wayfinding behaviours, this research defines appropriate routing criteria. For example, one computes a logical path related to the minimum number of visited spaces, because a user is inclined to distort her/his orientation after switching too many spaces. Figure 4.1 presents an example of two floors with different subdivision results (in a front view). The top floor (in light green) has fewer spaces than the ground floor (in dark green). Walking on the top floor would be easier for a user since she/he needs to memorize fewer spaces. Thus, logical paths derived by these criteria support the users who need a general path without the burden of details, and they can follow the general path with the help of signage or visualization on a mobile device.

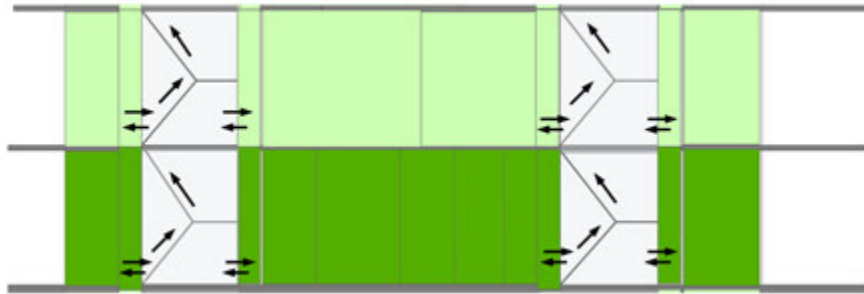

FIGURE 4.1 Two floors of a building contain a different number of spaces. The black arrows indicate the moving directions of two stairs (VU).

Each criteria is reflected by a weighted logical network, and a logical path is derived by minimizing the weights attached to each node of the logical network. To compute logical paths with multiple defined criteria, an optimization approach named *Lexicographical Goal Programming* [JT10] is adopted for routing (see Chapter 2). Section 4.2 presents the derivation process of the logical network. Section 4.3 introduces the routing criteria utilizing INSM semantics presented in Chapter 3, and Section 4.4 presents the computation of logical paths.

§ 4.2 Logical network derivation

Before the routing criteria are presented, this section introduces the derivation of a logical network from INSM. As mentioned in Chapter 3, Classes of *NavigableUnit*(*NU*) and *Opening*(*OPN*) are associated in *INSM*, which reveals the connection between *NU* and *OPN*. For instance, a door (*OPN*) links two other spaces (*NU*). Accordingly, the connection between the two spaces can be automatically confirmed (*i.e.*, edge of the logical network). In this way, all the connections can be confirmed regarding all the *NU*s in the

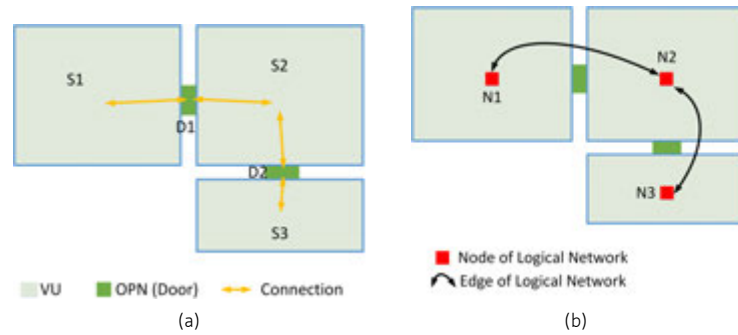

FIGURE 4.2 Derivation of a logical network. (a) Connection between OPN and NU; (b) Edges of a logical network.

building. The logical network consists of all the *NU*s (nodes) and these connections (edges). The nodes inherit the semantics of the spaces from INSM.

Figure 4.2 shows a simple example of a logical network derivation. *NU* represents the nodes of the logical network, and the connection between *NU* and *OPN* determined from INSM (D1 with S1 and S2, and D2 with S2 and S3 in Figure 4.2a). Then the edges of the logical network are inferred (Figure 4.2b).

Normally *NU*s derived from a specific subdivision would not change. As nodes of the logical network represent *NU* of a building, thus the logical network can generally be considered fixed. But the edges of the logical network can be influenced by an access permission issue, e.g., some *NU*s close due to a time restriction. In such a case, the logical network needs to be updated. In brief, for stable buildings a logical network can be created once and then stored for routing, but the logical network can also be created 'on the fly' according to the restriction on spaces.

§ 4.3 Routing criteria based on INSM semantics

Logical paths can be readily computed considering the semantics of indoor spaces. Taking INSM semantics as an example, a logical path needs to consider *VU* as the first priority when a user has to go to a different floor in a building. With more detailed semantics of indoor spaces such as a kiosk, a logical path can be computed using the functional use of the spaces. For instance, a user can ask for a logical path, which passes close to many kiosks.

This research adopts INSM semantics for routing on logical networks, which is based on three reasons: 1) The INSM semantics provides general navigational functions (i.e., horizontal or vertical, Connector or End) of indoor spaces; 2) the INSM semantics can be easily derived for different buildings in 2D and 3D data (e.g., CAD floor plans, *CityGML LoD4* and *BIM IFC*); 3) by using INSM, semantics can be assigned to any subdivision result of a building. In addition, the INSM can ideally depict complex indoor environments such as intermediate levels (a platform inside a large hall, see Figure 4.3). In

Figure 4.3, the semantics of each space indicate that the END (platform) is contained in the HC, and the VC-VU-VC connection links the END and the HC vertically.

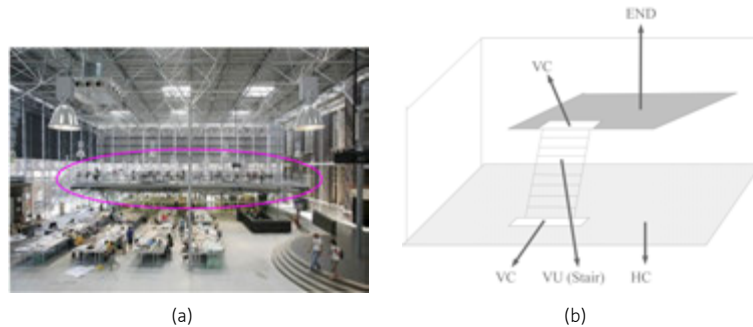

FIGURE 4.3 An example of a complex building depicted by INSM. (a) The platform in the middle of the large hall; and (b) the INSM semantics of spaces in this scenario.

To reduce the ambiguity in navigation on a logical network, six routing criteria are proposed (see below). The logical network is weighed according to each proposed criterion and minimizes the edge weights of the logical network according to the routing criterion. The proposed routing criteria aim to minimize node/edge weights to form a logical path. The weight of a node can indicate the importance of the node in the logical network for a specific purpose. Six criteria on logical network are designed from INSM semantics. Paths can then be computed with regard to each single criterion or by applying combinations of them.

These criteria are presented as follows:

- *Minimum NavigableUnit (NU)*. The criterion derives a path with the minimum number of traversed spaces (*i.e.*, *NU*). This means a user goes to a place by passing through as few *NUs* as possible.
- *Minimum HorizontalConnector (HC)*. This results in a path with the minimum number of *HCs*.
- *Minimum VerticalUnit (VU)*. The *Minimum VU* derives a path minimizing the number of *VUs* in a logical path.
- *Central HorizontalConnector (HC)*. Except for the start and target nodes, the *Central HC* results in a logical path preserving the high level of accumulated centrality of *HCs* and is also as direct as possible to the target. In a network the centrality of a node represents the accessibility and importance of the node to the other nodes [S.05].
- *HorizontalConnector (HC) Prior*. The *HC Prior* criterion results in a logical path prioritizing *HC* nodes and which is also as direct as possible to the target.
- *VerticalUnit (VU) Prior*. This criterion generates a logical path prioritizing *VU* nodes and which is also as direct as possible to the target.

The first three criteria (*Minimum NU*, *Minimum HC* and *Minimum VU*) are about the minimization of *NU*, *HC* and *VU* nodes in a logical path, respectively. The *Central HC* criterion provides a direct path (no detours) to the destination with high accumulated centrality of *HCs*. The *Central HC* path will have the higher accumulated centrality of *HCs* if there are other logical paths including the same number of spaces. The *HC Prior* and *VU Prior* paths are applied when *HC/VU* nodes have precedence to form a direct path to the destination.

The *central HC* evaluates the centrality of *HC* nodes in the logical network. There are different definitions of centrality such as degree, betweenness and closeness. The degree of nodes indicates the number of nodes connecting with a node. The closeness is the average length of the shortest paths between the node and all other nodes in the same graph [G.66, BV13]. In this sense, a node is 'central' when it is close to all the other nodes. The betweenness of a node is the ratio of the number of shortest paths via the node and that of all the shortest paths (among all the possible pairs of start and target nodes) [Bra01]. This thesis adopts the degree as the value of centrality for a logical network since it refers to the choices for the next step.

The above concepts are illustrated with the following example. Figure 4.4 presents an artificial building in the front view. Figure 4.4a presents a *minimum NU* path including the fewest number of spaces passed by a user. Figure 4.4b shows the logical network with a *minimum VU* path through only two *VUs* between the start and the destination. Figure 4.4b presents the stairs only; the *VU* class has three subtypes: *Escalator (ES)*, *Stair (ST)* and *Elevator (EL)*. Thus the *minimum VU* and *VU Prior* criteria have more derivatives, i.e., *minimum ES*, *minimum ST*, *minimum EL*, *ES Prior*, *ST Prior*, and *EL Prior*. The computation about these paths will be further explained in Section 4.4.

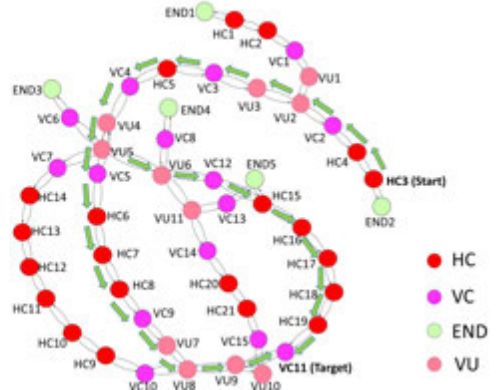
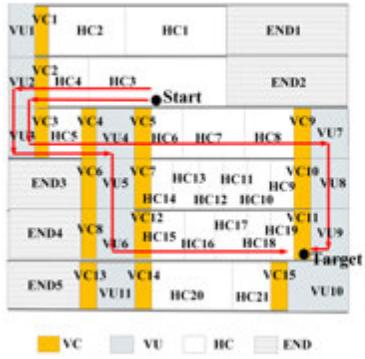

(a)

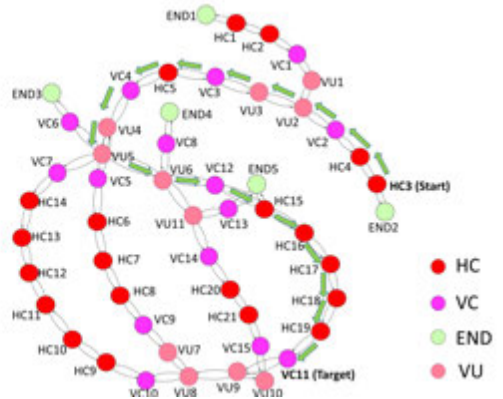
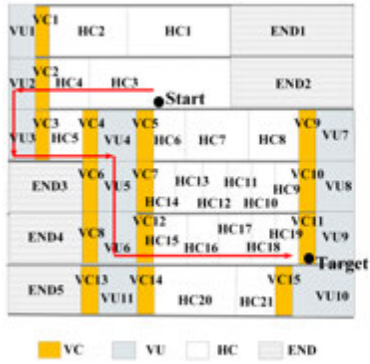

(b)

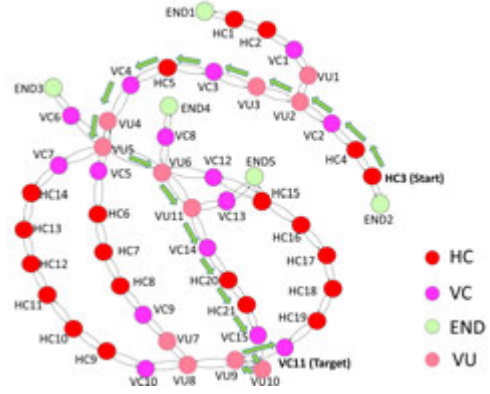
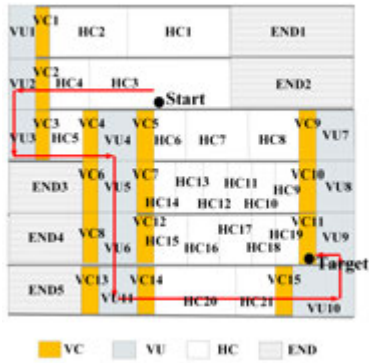

(c)

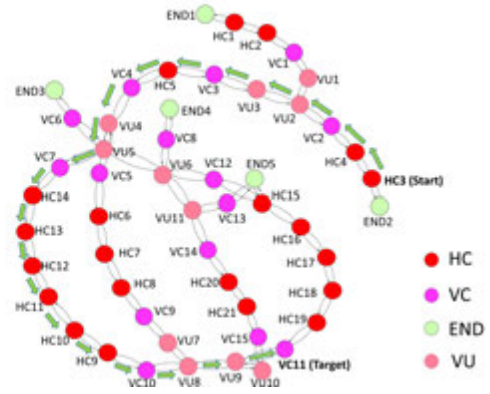
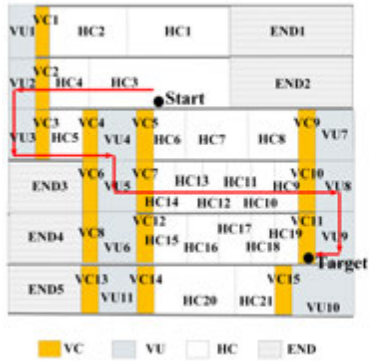

(d)

FIGURE 4.4 Illustration of four criteria in an artificial building. (a) A minimum NU path; (b) A minimum VU path; (c) A minimum HC path; and (d) An HC prior path. The HC prior path includes more HCs (HC9, HC10, HC11, HC12, HC13 and HC14) than the minimum HC path.

The *minimum HC* path ensures that a user can pass as few *HCs* as possible when she/he transits between the floors of the start and target spaces. Figure 4.4c presents a *minimum HC* path where the user transits stairs and passes only four *HCs* (HC4, HC5, HC20 and HC21) to arrive at the target.

Figure 4.4d presents an example of a *HC prior* path that crosses eight *HCs* (HC4, HC5, HC14, HC13, HC12, HC11, HC10 and HC9) to reach the target. Compared to the *minimum HC* path, the *HC prior* path includes more *HCs* and fewer *VUs*. In contrast, the *minimum HC* path has the fewest *HCs*, irrespective of the number of *VUs*.

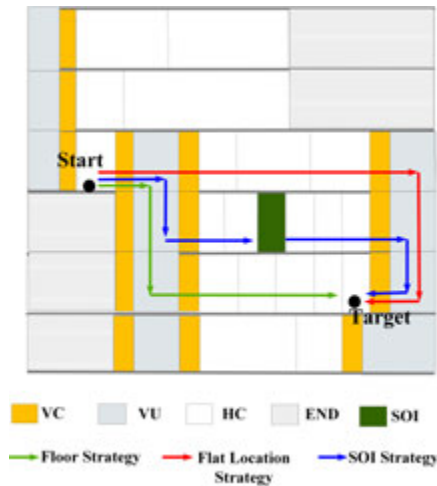

FIGURE 4.5 Illustration of the strategies of the floor, flat location and SOI.

The pedestrian wayfinding strategies mentioned by Hölscher *et al.* [HB07] can be realized by using the criterion *minimum NU*. In this thesis the three strategies are named as *floor*, *flat location* and *SOI* strategies. The *floor strategy* finds first the vertical position (*i.e.*, the floor) of the target space irrespective of the horizontal position of the target, while the *flat location strategy* aims to reach the approximate horizontal location of the space as directly as possible and regardless of switching floors. In this thesis the horizontal location is regarded as the closest *VU* space(s) to the target space on the target floor. The *SOI strategy* covers specified space(s) to be visited. These salient spaces act as landmarks [FLZS12] to the user. When the start and target spaces are on the same floor, the logical path does not need to be computed with the *floor* and *flat location strategies*, because both the strategies are related to paths crossing floors. Figure 4.5 provides examples of the paths conforming to the three strategies.

Each of the three strategies are denoted as several segmented *minimum NU* paths. The common ground among them is that the three strategies need segmented paths through one or more intermediate nodes in a logical network. Their main difference is in the choices of the intermediate nodes. The strategies of *floor* and *flat location* automatically specify the intermediate nodes by algorithms, while users need to specify intermediate nodes in the *SOI* strategy.

To implement the *floor* strategy, a simplified network of the original logical network is used to select the key *VU*. The simplified network consists of the start and target nodes and all the *VU* nodes (see Figure 4.6b). Each edge of the simplified logical network represents a number of *HC* and/or *VC* between the two nodes, and the weight of the edge is the number of these in-between the *HC/VC* nodes. The computation for a *floor* strategy path is presented in the following algorithm, which is illustrated in an artificial building (Figure 4.6):

Algorithm 1 Implement *floor* strategy in the logical network for routing.

Input: Logical network Net_l , the start node n_s , the target node n_t , the node set VU_{node} of all *VU*, and the simplified logical network Net_s consisting of just n_s , n_t and VU_{node} . Each edge of Net_s is weighted with the number of the in-between *NU* of the two nodes.

Output: The *floor* strategy path P .

```

1: procedure FLOORSTRATEGYPATH( $Net_l, Net_s, n_s, n_t, VU_{node}$ )
2:   from the set  $VU_{node}$ , select nodes  $VU_f$  on the same floor to the target.
3:   for each node  $vu_i$  in  $VU_f$  do
4:     compute the shortest path on  $Net_s$  from  $n_s$  to  $vu_i$ 
5:     record the total weight of the above shortest path to a value set  $W$ .
6:   end for
7:   locate the node VU with the lowest weight in  $W$ 
8:   compute the Minimum NU path  $p_1$  from  $n_s$  to VU on  $Net_l$ 
9:   compute the Minimum NU path  $p_2$  from VU to  $n_t$  on  $Net_l$ 
10:  aggregate  $p_1$  and  $p_2$  into the floor strategy path  $P$ 
11:  return  $P$ 
12: end procedure

```

For the *flat location* strategy, the simplified network of the original logical network is also used. The computation for *flat location* strategy path is presented in the following algorithm, which is also illustrated in the above artificial building (Figure 4.7):

Algorithm 2 Implement *flat location* strategy in the logical network for routing.

Input: Logical network Net_l , the start node n_s , the target node n_t , the node set VU_{node} of all VU , and the simplified logical network Net_s consisting of just n_s, n_t and VU_{node} . Each edge of Net_s is weighted with the number of the in-between NU of the two nodes.

Output: The *flat location* strategy path P .

```
1: procedure FLATLOCATIONSTRATEGYPATH( $Net_l, Net_s, n_s, n_t, VU_{node}$ )
2:   for each node  $vu_i$  in  $VU_{node}$  do
3:     compute the shortest path on  $Net_s$  from  $vu_i$  to  $n_t$ 
4:     record the total weight of the shortest path to a value set  $W$ .
5:   end for
6:   locate the node  $VU$  with the lowest weight in  $W$ 
7:   compute the Minimum NU path  $p_1$  from  $n_s$  to  $VU$  on  $Net_l$ 
8:   compute the Minimum NU path  $p_2$  from  $VU$  to  $n_t$  on  $Net_l$ 
9:   aggregate  $p_1$  and  $p_2$  into the flat location strategy path  $P$ 
10:  return  $P$ 
11: end procedure
```

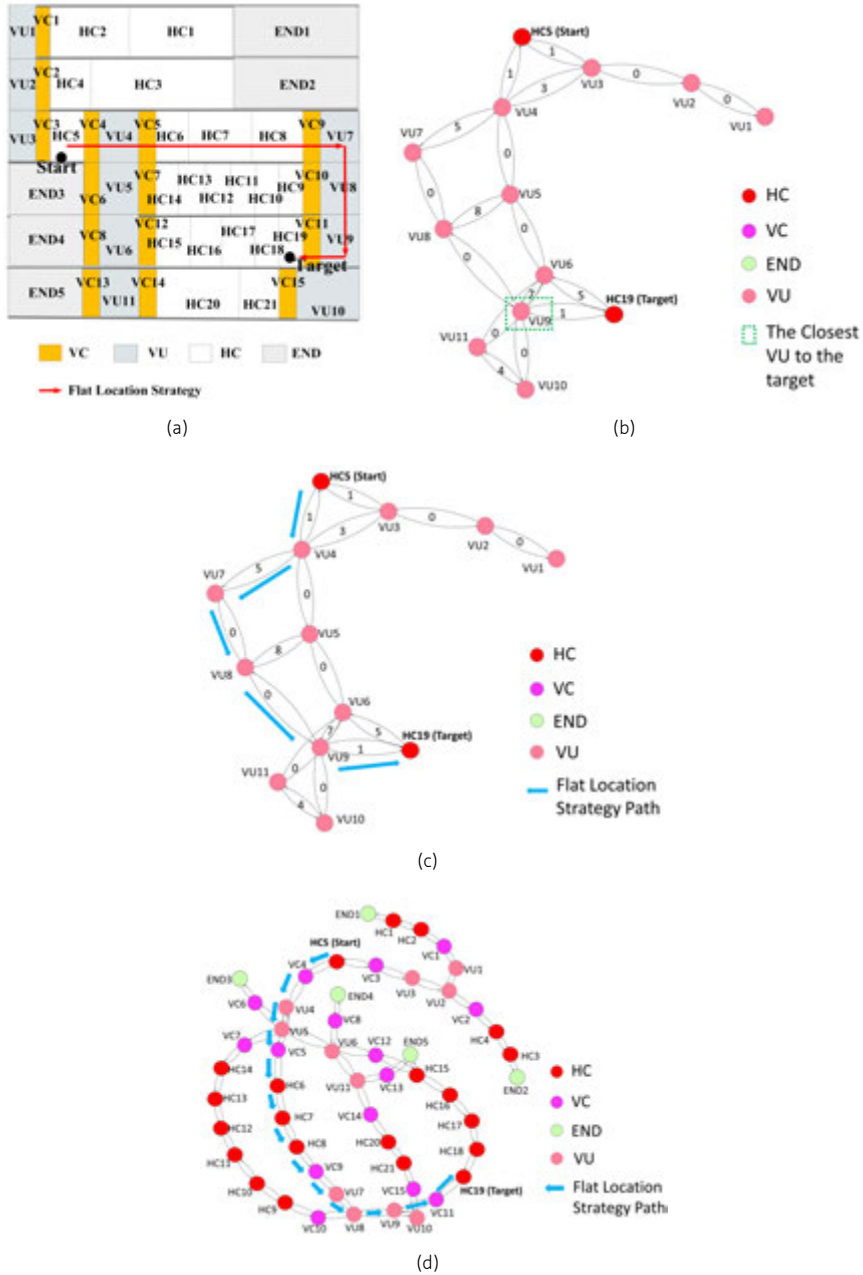

FIGURE 4.7 Illustration of the computation of the *flat location* strategy path. (a) The building in the front view. The start and target nodes are HC5 and HC19; (b) The simplified logical network. VU9 is the closest node to the target; (c) The *flat location* strategy path in the simplified network; and (d) The *flat location* strategy path in the original logical network.

The *SOI* strategy allows the user to select nodes in the logical network in an order. In such a case, a *minimum NU* path is computed between every two specified nodes sequentially (see Figure 4.5). All these *minimum NU* paths form the complete *SOI* strategy path.

Comparing the *floor* and *flat location* strategies, one can find that the two strategies first select the *VU* to the target and then compute related paths via the *VU*. However, the *floor strategy* selects the *VU* on the same floor of the target and closest to the start; the *flat location strategy* selects the *VU* closest to the target.

Additionally, a user can specify the subtype (*i.e.*, *EL*, *ST*, or *ES*) of *VU* in the *floor* and *flat location* strategies. For example, if a user specifies the subtype as *EL*, then a *floor/flat location* path is computed for the user by selecting only *ELs*.

§ 4.4 Routing procedure

Section 3.4.1 has introduced two routing options for the logical network. Option L1.1 is that a user provides NO *SOI*, while option L1.2 is the user specifies both *SOIs* and their ordering. The six proposed criteria *Minimum NU*, *Minimum HC*, *Minimum VU*, *Central HC*, *HC Prior*, and *VU Prior*, and the presented *floor strategy* and *flat location strategy* (*i.e.*, multiple segmented *Minimum NU* paths) are applied to option L1.1. In these cases, a user can receive a logical path or 'No Path' message from path computation by selected criteria/strategies. The *SOI strategy* (*i.e.*, multiple segmented *Minimum NU* paths via user-specified nodes) is applied to option L1.2, because the group of ordered nodes specified by users in this strategy are the specified *SOIs*. The rest of this section will present path computation with these criteria. Then paths from the three presented strategies [CTG⁺06] can be computed based on the *Minimum NU* criterion.

As the logical network is basically a graph, therefore these criteria have to be presented as weights to the edges or the nodes. Subsection 4.4.1 firstly introduces how to define edge weights of the logical network for different criteria. Then Subsection 4.4.2 presents routing computation with a singular criterion, and elaborates the path computation when multiple criteria are needed.

§ 4.4.1 Weighted routing

The nodes of the logical network hold the semantics of the spaces which define the priority for navigation. In a logical network, edges indicate connectivity among nodes but nothing more. A logical path represents a sequence of spaces to be passed. Thus weights are assigned to logical nodes first, then transmit these weights to logical edges. Consequently, the weight of an edge reflects the significance of its emitting node (see Figure 4.8).

Routing with the criterion is to minimize the edge weights. In this way, graph-based algorithms are employed to obtain logical paths. For the purpose of minimization, the following values are used: 0 means the node can be either in or not in a path, which is neutral (does not affect the result) to the path computation; a relatively large value such as 1000 means a user tries not to adopt the node in a path; and a lower value such

as 1 means it is a normal node and the number of nodes in the given type (e.g., HC) is preferred and would be counted in a path.

As shown previously, routing on the logical network relies only on *HC*, *VC* and *VU* nodes with the start and the target nodes. *END* nodes are not considered when routing is performed on the logical network. Therefore no weights are set for them. For each criterion, node weights are chosen in the light of node semantics. Table 4.1 presents all the node weights for the six proposed criteria and their variants (e.g., the *Minimum EL* is a variant of the *Minimum VU*). All the criteria are separated into two groups: 1) minimizing specific type; and 2) setting priority to specific types (see Table 3.2). The first group aims to minimize the given space type(s) (e.g., *HC*) in a logical path, regardless of the other types of nodes (e.g., *VC* & *VU*); the second group sets the priority for the given space type(s) and also averts the other space types as much as possible for a path.

TABLE 4.1 The weights of nodes of the logical network for these proposed criteria.

Type	Criteria	HC	VC	EL	VU ES	ST
Minimizing specific types	Minimum NU	1	1	1	1	1
	Minimum HC	1	0	0	0	0
	Minimum VU	0	0	1	1	1
	Minimum EL	0	0	1	1000	1000
	Minimum ES	0	0	1000	1	1000
	Minimum ST	0	0	1000	1000	1
	Minimum EL&ES	0	0	1	1	1000
	Minimum EL&ST	0	0	1	1000	1
	Minimum ES&ST	0	0	1000	1	1
Setting priority to specific types	Central HC	1000-Centrality	1000	1000	1000	1000
	HC Prior	1	1000	1000	1000	1000
	VU Prior	1000	1000	1	1	1
	EL Prior	1000	1000	1	1000	1000
	ES Prior	1000	1000	1000	1	1000
	ST Prior	1000	1000	1000	1000	1
	EL&ES Prior	1000	1000	1	1	1000
	EL&ST Prior	1000	1000	1	1000	1
	ES&ST Prior	1000	1000	1000	1	1

The first group (i.e., minimizing specific type) includes *minimum NU*, *minimum HC*, *minimum VU*, *minimum EL*, *minimum ES*, *minimum ST*, *minimum EL&ES*, *minimum EL&ST*, and *minimum ES&ST* (see Table 4.1).

The criterion of *minimum NU* indicates that all nodes in a logical network are equally important, because each step for a user is to pass through a space. Thus 1 is set for all the nodes. The choices of *VUs* are not important for the criterion of *minimum HC*. Thus 0 is set for all the *VC* and *VU* nodes, while 1 is set for the *HC* nodes. For the same reason 0 is set to all the *VC* and *HC* values in the logical network for the *minimum VU* path, and 1 for all the *VU* nodes (*EL*, *ES*, and *ST*). The *minimum VU* criterion has six variants including *minimum EL*, *minimum ES*, *minimum ST*, *minimum EL&ES*, *minimum EL&ST* and *minimum ES&ST*. In these variants one or two subtypes of *VU* are emphasized, which means the subtypes are the first choice as *VU* for a path. Similar to the *minimum VU*, the six criteria set all the *VC* and *HC* values to 0; and the emphasized subtypes of *VU* are set to 1, while the other subtypes of *VU* are set to 1000 (see Table 4.1). For example, in the *minimum EL* criterion, the emphasized subtype is *EL* and then all the *EL* nodes are set to 1. The rest of the subtypes, i.e., *ES* and *ST*, are all set to 1000. In contrast, for the *minimum ES&ST* criterion, all the *EL* nodes are set to 1000 and the *ES* and *ST* nodes are set to 1, because *ES* and *ST* are the emphasized subtypes (see Table 4.1).

The second group (i.e., setting priority to specific types) includes: *central HC*, *HC Prior*, *VU Prior*, *EL Prior*, *ES Prior*, *ST Prior*, *EL&ES Prior*, *EL&ST Prior*, and *ES&ST Prior* (see Table 4.1). For *central HC*, 1000 is assigned to *VC* and all the *VU* nodes, which avoids adopting many *VC/VU* nodes. The *HC* nodes are set to the value subtracting their centrality from 1000. Because the *central HC* criterion aims to collect the high accumulated centrality of nodes in a direct path to the target by minimizing weights (see Section 4.3), the weight (centrality value) is adapted to the monotonicity of the minimization (i.e., to the lower accumulation) by subtracting the centrality of the *HC* nodes from the large number 1000.

HC Prior relates to horizontal movements. Thus 1 is set to the *HC* nodes (with high priority in a path) and 1000 to the other nodes (with the lower priority). Except for the *central HC* and *HC Prior*, the others in the second group concentrate on vertical movements. Similarly, 1 is set to nodes of the specified subtype(s) of *VU*, and 1000 to *HC*, *VC* nodes and nodes with the other subtypes of *VU* (see Table 4.1).

Algorithm 3 Derive edge weights from node weights in a logical network

Input: A logical network G , the values Ws of node weights.

Output: The logical network G where the edges have been weighted in light of Ws .

```

1: procedure DERIVEWEIGHTS( $G$ ,  $Ws$ )
2:   for each node in  $G$  do
3:     find the edge set  $Es$  emitted from the node
4:     look up the weight  $val$  of the node in  $Ws$ 
5:     for each edge  $e \in Es$  do
6:       the weight of  $e$  is set as  $val$ 
7:     end for
8:   end for
9:   return  $G$ 
10: end procedure

```

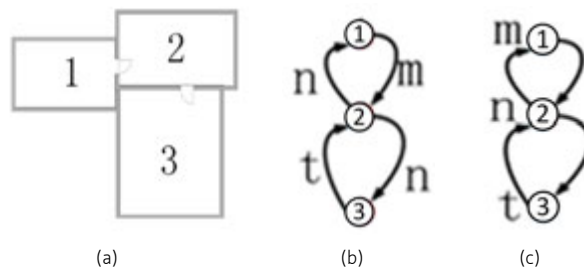

FIGURE 4.8 Derivation of edge weights from those of nodes in a logical network. (a) Three rooms; (b) Weights of nodes; and (c) Transition to edge weights.

As mentioned above, the node weights are transformed to edge weights and then the *Dijkstra* algorithm [Dij59] is applied. Given a node property, Algorithm 3 presents the method that converts the node values to those of related edges. For each node the algorithm locates first the outgoing edges of the node, and picks the node's value. Subsequently, it sets the weights of all the outgoing edges with the node's value. Figure 4.8a presents three rooms, and Figure 4.8b presents their logical network and the

attribute values (i.e. m , n and t) of the nodes. Figure 4.8c presents the derived edge weights in the logical network.

§ 4.4.2 Multi-criteria routing

As discussed previously, a logical network is tailored for each specific user. Firstly, accessibility to all the edges of the logical network is confirmed. Secondly, the time restriction on all the edges will be investigated as well. Next, the network is simplified by removing all the nodes which are not accessible. These inaccessible nodes and related edges are removed in a given period. Then the remaining logical network is what is used for path computation. Figure 4.9 provides an example of time constraint on accessibility in a floor plan. This is the ground floor of the Architecture Faculty building at the Delft campus. The spaces of one section are inaccessible to visitors after 6 p.m. every day. Thus the related nodes and edges are removed (see Figure 4.9). Generally users with different authorizations obtain distinct logical networks.

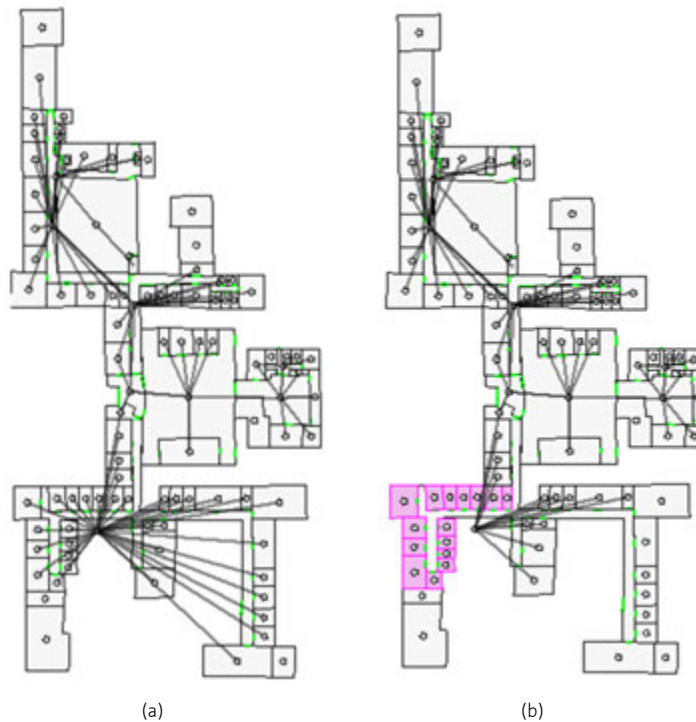

FIGURE 4.9 Time constraint on accessibility to a logical network. The logical network is embedded in spaces. (a) The original logical network; and (b) The modified logical network where the nodes and edges of a section are removed after work time.

Multiple logical paths may be derived with just one single criterion. All the resulting paths can be reported if they are equal according to a singular criterion. For example, in a building a user gets two *minimum NU* paths from the entrance hall to an offices via

two separate stairs. The user can select one of them based on the visualization of both paths.

To find out a subset of the 'better' paths for users among a number of alternatives, multiple criteria are employed in sequence (the 1st, 2nd, 3rd...) in routing according to the *Lexicographical Goal Programming* [JT10]. The users can specify multiple criteria in different priority orderings. Thus a priority ordering of criteria is leveraged to compute logical paths.

Algorithm 4 Compute logical paths with ordered criteria in a priority list on a logical network

Input: A prioritized list of ordered routing criteria F , a logical network N .

Output: The set of logical path(s) Sp .

```

1: procedure MULTICRITERIAROUTING( $F$ ,  $N$ ,  $Sp$ )
2:   for criterion  $f_i$  in order in  $F$  do
3:     if  $Sp$  is empty then
4:       compute paths in  $N$  according to  $f_i$ 
5:       add the paths into  $Sp$ 
6:     else
7:       compute paths in the paths of  $Sp$  according to  $f_i$ 
8:       replace the  $Sp$  by the new paths
9:     end if
10:
11:   if  $Sp$  contains only one path then
12:     return  $Sp$ 
13:   end if
14: end for
15: return  $Sp$ 
16: end procedure

```



FIGURE 4.10 The workflow of routing with priority ordering of criteria.

Algorithm 4 presents the computation process with a priority order of multiple criteria. By following the *Lexicographical Goal Programming* [JT10], this procedure is to compute a set Sp including all the semantic paths with the first criterion (lines from 3 to 5); second, it continually selects paths from Sp with the next criterion, and then replaces Sp with the newly selected paths (lines from 6 to 9). If there is only one path in Sp , then it is the final path (line 12); otherwise, this procedure keeps selecting paths from Sp according to the next criterion in the order. If all the criteria in the priority order have been applied and Sp still includes multiple paths, then all the paths in Sp are regarded as the final paths. Ultimately, the set Sp includes all the semantic paths resulting from the priority order. This computation obtains either one path or several equally-optimal paths. Figure 4.10 presents the workflow of routing with priority ordering.

In practice, when considering the profile of users the importance of each type is sorted for distinct users with different profiles. These sequences of types of path are transformed into the priority ordering of criteria.

To sum up, in order to compute logical paths for a specific user, this research requires: 1) a user-related logical network; 2) a priority ordering of criteria to the user; and 3) the routing workflow. This workflow may generate one or several paths at the end of the computation. The final paths are regarded with the same importance. In an application, one can visualize all the paths and ask users to select one, or randomly choose one.

Besides the *Lexicographical Goal Programming*, there are more means to reduce the chance of getting multiple logical paths. For example, to design more criteria by assigning distinct weights in the logical network. Multiple logical paths can result from simple weights, such as *HC* nodes with 1 and the others with 0 in minimum *HC*. In this case, if *VC* nodes are set to a larger value (e.g., 3) to emphasize their importance, then the previously multiple paths may be reduced. However, the difficulty is to motivate the increased weights of *VC*, i.e., what kinds of scenarios need them. Thus this topic is left for future investigation.

§ 4.5 Summary

Routing on the logical network is related to user status (e.g., motion ability, size of user and access permission) and her/his preference for indoor spaces and paths. Two users with different access permissions would get distinct logical networks for the same building. In the same network, two users with different preferences may obtain different logical paths. This chapter answers and explains the following research sub-question:

4. What kind of routing criteria can be built (or specified) by using the semantics of indoor spaces?

Section 4.1 introduces the motivation of routing on the logical network, i.e., to simulate human wayfinding behaviours. In such a routing users involve different preferences of space. In order to reflect the preferences, routing criteria are designed based on the semantics of indoor spaces.

Section 4.2 presents the derivation of a logical network. Based on the association of *NU* and *OPN* in *INSM*, the logical network can be automatically derived. The semantics of nodes in the logical network is retrieved from *INSM*.

For the research question, Section 4.3 explains why the semantics of spaces is needed by pedestrians for routing and presents the advantages of using *INSM* semantics for routing. Then six routing criteria are proposed on the *INSM* semantics: 1) *Minimum NavigableUnit* minimizes the number of traversed spaces; 2) *Minimum HorizontalConnector* minimizes the number of *HorizontalConnector* in a path; 3) *Minimum VerticalUnit* minimizes the number of *VerticalUnit* in a path; 4) *Central HorizontalConnector* preserves the high accumulated centrality of *HorizontalConnector* in a path; 5) *HorizontalConnector Prior* prioritizes *HorizontalConnector* nodes and also makes the path as

direct as possible to the target space; and 6) *VerticalUnit Prior* prioritizes *VerticalUnit* nodes and also makes the path as direct as possible to the target space. Besides, three existing pedestrian wayfinding strategies [CTG⁺06] are adopted as algorithms in Section 4.3, *i.e.*, *floor strategy*, *flat location strategy*, and *SOI strategy*. These proposed criteria are not an exhaustive list. More routing criteria can be designed in terms of other user needs on space.

Section 4.4 introduces the computational steps of routing on the logical network that are weighted according to the semantics of logical nodes for different criteria. Logical paths can be computed for users by using only a singular criterion or a sequence of ordered criteria. A criterion reflects a specific user's preference on indoor spaces; and the user profile can be linked to the priority ordering of multiple criteria for the user.

As mentioned in Section 3.4.1, two options (L1.1 without SOI and L1.2 with ordered SOI) are summarized for obtaining logical paths. Option L1.1 is related to the six proposed criteria, the *floor* and *flat location* strategies. These criteria and the two strategies can automatically derive logical paths for a user. Option L1.2 is reflected by the *SOI* strategy where a user needs to specify nodes (SOIs) to be passed in the logical network.

In the two-level routing approach, a logical path is computed first when geometric paths are required. The geometric network can be generated 'on the fly' for the relevant spaces after the logical path is given. Specifically, a new logical path is needed when there is no available geometric path in the geometric network. The next chapter will present the generation of the geometric network and routing in this network. Routing in the geometric network generates accessible and obstacle-avoiding paths for users with a given size.

5 Routing on geometric networks

This chapter presents routing on the geometric network of a building. As addressed in previous chapters, this routing aims to compute a detailed geometric path that avoids indoor obstacles with respect to pedestrian-related sizes. Indoor spaces can contain a large variety of static objects, which obstruct navigation, such as desks, chairs, tables and other furniture. A geometric network can be created for specified spaces by considering the shapes of the indoor static obstacles. In this thesis, a visibility graph method [OW88, AW88] is adopted to generate geometric networks regarding obstacles. In order to compute accessible paths for a given user, the distance between the obstacles and their distance to walls should be taken into account. In the 2D plane, a pedestrian-related size is defined as the diameter of the circumcircle that covers the pedestrian and the devices/objects (e.g., wheelchair or suitcase) she/he carries/drives. The size of pedestrian is named 'user size' in short.

This chapter focuses on the generation of geometric networks and proposes the generation approach: for the selected spaces of a given logical path, a subnetwork is created for each space and then the subnetworks form the geometric network for the selected spaces. Routing on the geometric network can be computed by using traditional methods, such as the *Dijkstra* algorithm [Dij59]. Section 5.1 presents the motivation for using the visibility graph method to construct geometric networks, which can preserve corner points (i.e., turns) in geometric paths. Section 5.2 elaborates the generation of geometric networks considering user sizes, including the method to include user size, creation of geometric edges, the network formed by the edges, and geometric network generation for changing user sizes. Section 5.3 briefly summarizes the whole chapter. This chapter is based on two author's own publications: [LZ11a, LZ15].

§ 5.1 Motivation

As presented in Chapter 3, the geometric network is created on the second level in selected spaces. This section introduces the general process of geometric network derivation for indoor spaces with obstacles. Except for obstacles, a user needs to specify POIs and their ordering in routing option G2.2 (with ordered POI, see Section 3.4.2). In this case the generation of the geometric network needs to input the given ordered POIs.

Chapter 2 discussed several approaches for computing the geometric network. The commonly used S-MAT [EE99, CL09] paths do not provide direct paths inside of irregular indoor spaces (see Figure 5.1), and therefore other approaches have been investigated. For example, the approach direct path graph (DPG) [YS11] computes the shortest paths in spaces without creating a complete geometric network. However, this method cannot ensure the shortest path in a given space (see Figure 5.2), e.g., some irregular-shaped spaces [LZ11b]. For comparison, Figure 5.2 illustrates a DPG path between two doors in an irregular-shaped room. The DPG path is derived by dividing the straight line between the start and target locations each time when the line intersects

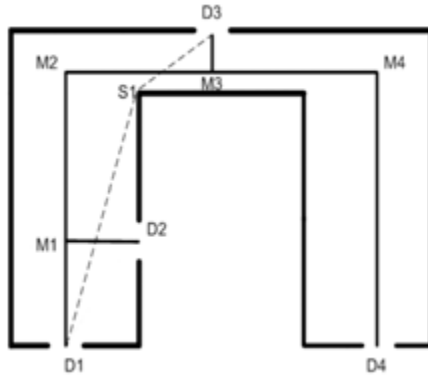

FIGURE 5.1 Comparison of S-MAT and direct paths. A S-MAT path (solid lines) along a corridor is D1-M1-M2-M3-D3, and the shorter direct path (dashed lines) is D1-S1-D3 without considering user size (from [LZ11a]).

a non-convex boundary. The path computed based on the VG (Figure 5.2b) is the genuine shortest path between the two locations.

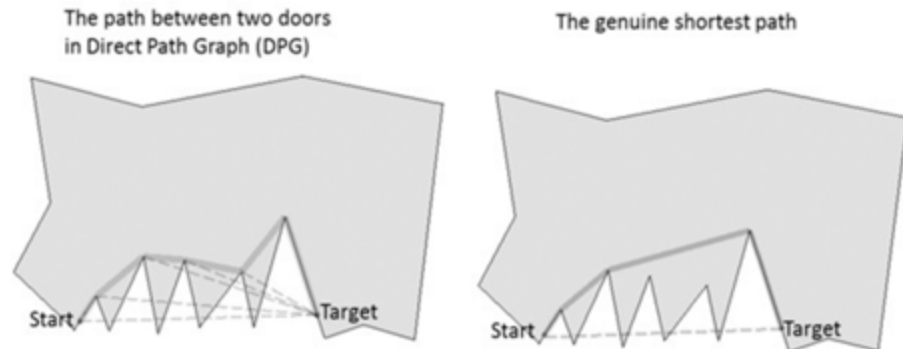

FIGURE 5.2 Comparison of a DPG path and the shortest path. On the left is the DPG path, and on the right is the shortest path between the start and target locations (from [LZ11b]).

As mentioned in Chapter 2, this thesis adopts the visibility graph (VG) method [OW88, AW88] to facilitate the generation of geometric networks. Indoor obstacles significantly influence the form of a geometric network. This thesis concentrates on static obstacles represented by disjointed 2D polygons (e.g., floor plans) or 3D volumes (e.g., IFC data). An obstacle (i.e., an object) occupies a certain region in a space. To be able to create a geometric network, a number of vertices are considered: opening centers, obstacle vertices, POIs and non-convex corners of the related spaces. Edges of the VG are the direct path between two VG nodes.

This thesis denotes geometric paths by straight lines. It is assumed that a user can perceive a turn (or a corner) as a significant 'landmark'. This path is computed considering the corner points and they are indicated in the path. In reality a user would keep a distance to obstacle corners as a collision-free path but such computation and visualization of the path is not realized. This thesis adopts the simple visualization of a path which clearly includes corner locations, which highlights the turns for pedestrian motions. However, the distance between obstacles is taken into account, which lays a foundation for routing regarding user sizes.

According to the definition in Chapter 3, a geometric network consists of the shortest paths among opening locations and POIs. Specifically, the geometric network is a subset of the VG (see Figure 5.3). Nodes of the VG include obstacle vertices, door center locations, POI and non-convex vertices of the space. Once the VG is created for a space, the geometric network for the space can be derived by computing all the shortest paths between openings (doors) and POIs (see Figure 5.3). Similarly, geometric networks can be created in a set of spaces or all indoor spaces together.

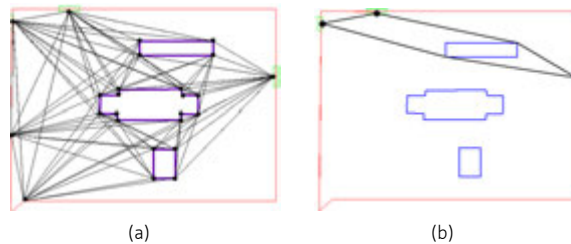

FIGURE 5.3 Comparison of VG and geometric networks. (a) VG. Dots represent VG nodes and black lines are VG edges. Blue polygons are obstacles; and (b) The geometric network. Dots represent geometric nodes (doors), and the shortest paths among the nodes are geometric edges.

§ 5.2 Geometric network generation

A geometric network can be derived from the geometry stored in the INSM. In this chapter, nodes are referred to as the center of door locations, and these nodes normally would not change in the building. It should be noted that nodes of a geometric network are always the same, but edges may differ for distinct users. When a new geometric network is created for a given user, only the edges need to be updated among these doors according to the user. Thus this section focuses on the computation of geometric edges among door nodes considering user sizes. In this thesis the term 'bottleneck' is introduced to indicate the region (*i.e.*, inaccessible gap) between two obstacles where a user with the given dimension cannot pass through.

Subsection 5.2.1 presents the adopted method to consider user size for routing in geometric networks. This method groups obstacles by comparing distances among obstacles to a user's size, and then derives geometric edges among these groups of obstacles. Subsection 5.2.2 briefly introduces the computation of accessible geometric edges between two doors, which includes six steps: 1) find bottlenecks (Subsection

5.2.3); 2) group obstacles according to these bottlenecks (Subsection 5.2.4); 3) select obstacle groups between the two doors (Subsection 5.2.5); 4) create boundaries for selected groups (Subsection 5.2.6); 5) find bottlenecks with walls (Subsection 5.2.7); 6) create a VG based on these groups by avoiding the bottlenecks with walls (Subsection 5.2.8) and then compute the accessible edges. Subsection 5.2.9 introduces how to construct a geometric network from the accessible edges in the given spaces for an independent user. Finally, Subsection 5.2.10 presents the generation of different geometric networks for users with dissimilar sizes.

§ 5.2.1 Approach to consider user size

User sizes are specifically important for facility management and maintenance. For example, a member of the maintenance staff in a factory operates a large vehicle (see Figure 5.4a, or a staff member in an airport transports different goods with a wheeled cart (see Figure 5.4b). All of these cases require paths that can consider the total size of pedestrians and the objects they operate/carry.

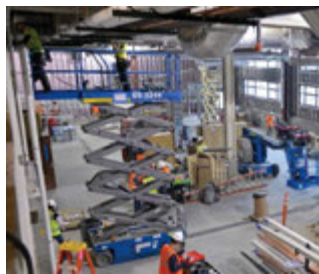

(a) (from: www.jw.org/nl/jehovahs-g-etuigen/activiteiten/bouwprojecten/warwick-fotogalerij-mei-augustus-2014/)



(b) (from www.upi.com/Business_News/2013/03/12/Spain-airports-to-start-luggage-cart-fee/53421363096254/)

FIGURE 5.4 Example of user sizes. (a) Building maintenance with equipment; and (b) Staff with a baggage cart in an airport.

As discussed in Chapter 2, robot motion planning has always taken into consideration robot dimensions. The so-called *Minkowski sum* method [dBCvKO08, Coe12] has been commonly applied to identify inaccessible areas for a robot, yet the Minkowski sum approach tends to generate non-simple geometry (see Figure 5.5). Such a geometry is not convenient for creating a navigation network, because it can derive inner rings and self-intersection of polygons. Thus the generated geometry needs to be merged and cleaned. Edges touch each other at the polygon of the merged Minkowski sums, which increases the redundancy of vertices (Figure 5.5b). Furthermore, the generated polygons (see Figure 5.5) either include arcs or too many vertices (e.g., the ‘curved’ parts). Figure 5.5 presents two union results of the Minkowski sums. An isolated inner ring (see Figure 5.5a) is part of the merged Minkowski sums of the six objects. The inner ring can be removed since the user can never access it from outside. Figure 5.5b presents the case of self-intersection: several edges touch each other or overlap within a tolerance at the polygon of the merged Minkowski sums, which increases the redundancy of vertices. They need to be cleaned, i.e., the edges are merged and removed. The

generated polygons include arcs or too many vertices (e.g., the 'curved' parts), which complicates the creation of the network.

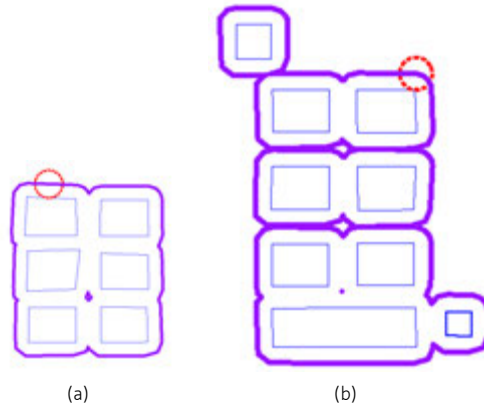

FIGURE 5.5 The union of Minkowski sums contains inner rings and self-intersections. (a) The union of Minkowski sums with one inner ring (the circle denotes a user); and (b) Self-intersection and inner rings of the Minkowski sums.

This thesis addresses the inner rings and self-intersection issues by directly measuring the *minimum distance (MD)* between the obstacles and determining the boundaries of obstacle-occupied areas with fewer vertices. One can find bottlenecks between obstacles with MDs. A bottleneck is inaccessible since the MD of the bottleneck is shorter than the user size. Indoor obstacles sharing bottlenecks are regarded as a group. A simple polygon is computed to bound multiple obstacles when their inside is not accessible to the user. The term 'simple' refers to the simple features in the standard [OGC11] of the Open Geospatial Consortium. With the same objects in Figure 5.5, simple polygons are derived as the boundaries of the two groups of obstacles (see Figure 5.6). Compared to Figure 5.5a, the polygon (*i.e.*, boundary) in Figure 5.6a has no inner rings. The polygon in Figure 5.6b has fewer vertices compared to the one in Figure 5.5b.

An accessible shortest path (*i.e.*, geometric edge) can be computed between two given locations with groups of obstacles when the obstacle groups influence the path. Regarding this approach, all the following illustrations are only about 'door-to-door' computation in a space. In this section, only doors are considered to compute geometric edges, and no POIs or windows are presented.

In Figure 5.7a, the obstacles on the left side of (outside the convex hull denoted by black lines) the room do not influence the direct path between the two doors (the blue line) based on the VG. These obstacles are excluded by the method in Section 5.2.2 about selecting obstacle groups with a convex hull with the proof in Appendix A. Figure 5.7 illustrates geometric edge generation with simple boundaries of obstacle groups for a user:

1. A VG for the user is constructed with only the two groups on the right side of the room (see Figure 5.7b);

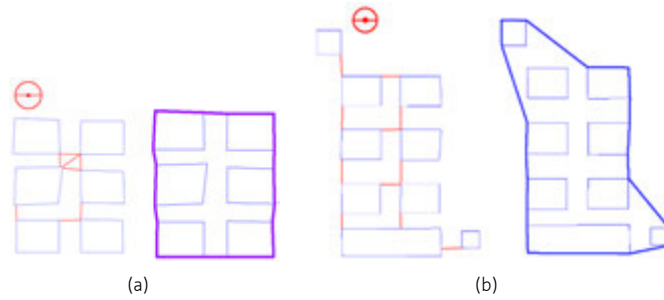

FIGURE 5.6 Polygonal boundaries of objects according to inaccessible gaps. The circle denotes a user with a device, and the red lines represent inaccessible gaps. (a) The polygonal boundary without inner rings; and (b) The simple non-convex boundary.

2. To consider the gaps between walls and obstacles, a buffer is introduced (see Figure 5.7b) which is equidistant from all of the walls with the user size. The final VG for the user is computed by considering the inaccessible gaps in the area of the buffer. In this buffer, the inaccessible gaps between the walls and the obstacles are presented as red lines in Figure 5.7b. The edges of the VG that intersect these inaccessible gaps are removed.
3. Subsequently, the shortest path (*i.e.*, geometric edge) is computed on the VG (see Figure 5.7c). The path on the nodes of the boundaries (see Figure 5.7c) is a schematic path, and it provides clear directions and illustrates where the user can pass.
4. A realistic path considering the size of the user is visualized in Figure 5.7e.

For the sake of simplicity, the remainder of this thesis only visualizes paths as schematic paths. But as an example, a simple method to reconstruct a realistic path is presented in Figure 5.7d:

1. Find the related obstacle groups to the schematic path;
2. Compute Minkowski sums for these groups;
3. Locate the intersection points of these Minkowski sums and the schematic path, and find the part of the schematic path inside the Minkowski sums;
4. If any part of the schematic path is inside these Minkowski sums, then replace the part by the bound of the corresponding Minkowski sum, which forms a realistic path as a user's accurate trail (see Figure 5.7e).

For a space, a geometric network consists of all the accessible paths when a user size needs to be considered. As mentioned before, based on a VG the shortest paths among door locations and/or POIs form a geometric network. For distinct user sizes, different geometric networks could be created in a space.

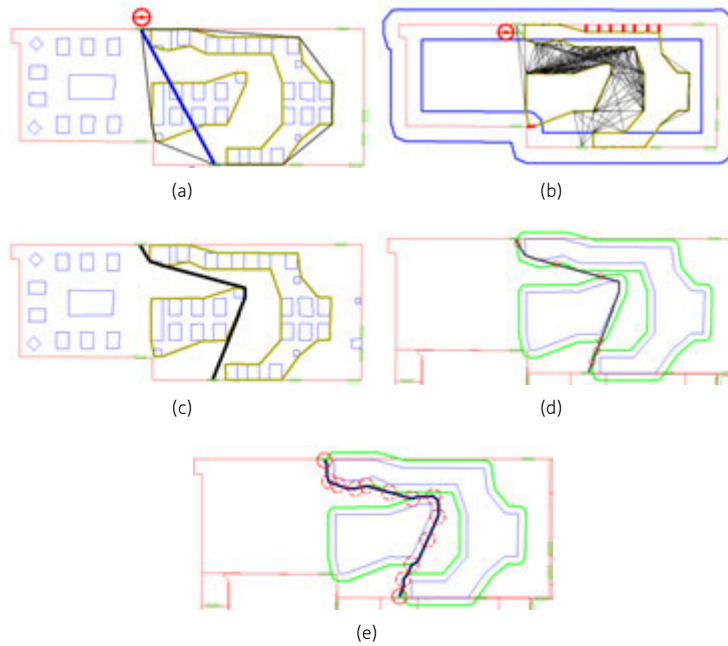

FIGURE 5.7 Path computation with simple boundaries of obstacle groups for a user: (a) Selection of groups of obstacles between two locations. The circle denotes the user; (b) the VG considering the inaccessible gaps between obstacles and walls; (c) a schematic representation of the computed 'shortest' path (in black) in the VG; (d) a way to compute the realistic path; and (e) a realistic path by considering the user size.

§ 5.2.2 Edge generation of geometric networks

In this thesis, a new path computation approach is proposed to avoid static obstacles and obtain indoor paths with respect to the user dimension. In a space, the approach computes the accessible shortest paths between two locations for users with different sizes. A geometric network is created for a set of spaces, which is the union of the sub-networks in each space.

The proposed approach excludes inaccessible spaces for a user in six steps (see the highlighted parts in Figure 5.8):

1. Compute the MDs between the indoor obstacles of each room by applying the Rotation Callipers algorithm [Tou83]. Inaccessible gaps are obtained when an MD between obstacles is shorter than the user's dimensions (Section 5.2.3).
2. Group obstacles according to the inaccessible gaps (Section 5.2.4).
3. Between two locations, select necessary groups of obstacles to construct a geometric network by applying a convex hull-based method (which will be elaborated in Section 5.2.5).
4. Compute non-overlapping boundaries with simple geometry for the selected groups based on the Delaunay Triangulation [dBCvK008] and the alpha shape method [EM94, AEF⁺95] (Section 5.2.6).
5. Compute MDs between these selected groups and walls, and locate inaccessible gaps (Section 5.2.7).
6. For single spaces, create geometric edges for users with the groups' boundaries and remove edges crossing inaccessible gaps between the boundaries and walls (Section 5.2.8). Then form a geometric network for related spaces with these geometric edges (Section 5.2.9).

Finally, a path can be computed to accommodate the user with the given size. The following subsections elaborate each of the above steps.

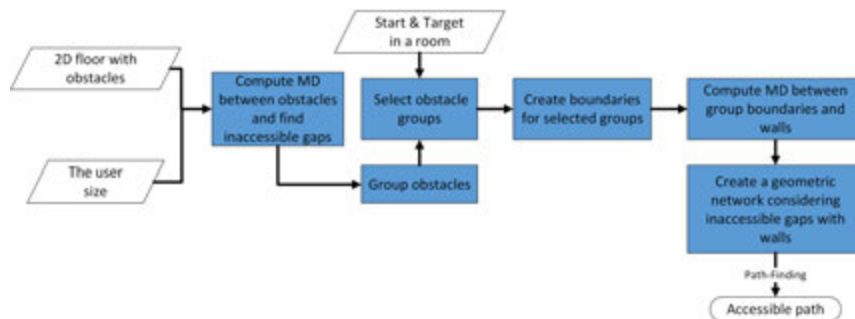

FIGURE 5.8 Overview of the proposed approach.

§ 5.2.3 Compute MD between obstacles and find inaccessible gaps

As mentioned before, the proposed approach makes use of the MD between obstacles, which aims to detect bottlenecks. Obstacles with bottlenecks are to be categorized into a group. A path around the group is provided to the user. This paper employed the rotation callipers algorithm [Tou83] to compute the MD between obstacles. As this algorithm is applied to convex polygons, non-convex obstacles are subdivided into convex parts to compute their MDs with other obstacles. Figure 5.9 illustrates the MD computation between two non-convex polygons:

1. The two polygons are subdivided into different convex parts [CD85] (Figure 5.9a), such as convex parts of 1 and 2 to the non-convex polygon A, and the convex parts 3 and 4 to polygon B;
2. To compute the MD between each convex part of A and that of B with the rotation callipers algorithm, and four MDs are derived *i.e.*, D_{13} , D_{23} , D_{14} , and D_{24} (Figure 5.9b). The subscripts denote the related convex parts of A and B;
3. Finally, the lowest MD is the MD between the non-convex polygons A and B (Figure 5.9c).

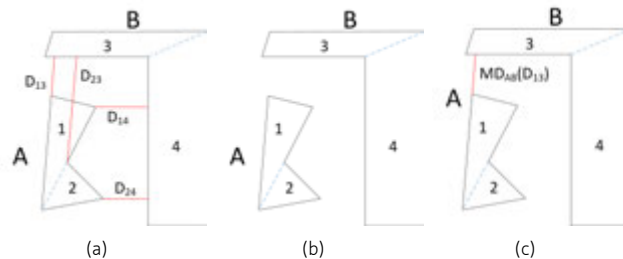

FIGURE 5.9 MD computation for two non-convex polygons. (a) Each non-convex polygon becomes different convex parts; (b) MDs between each convex part of A and that of B, *i.e.*, D_{13} , D_{23} , D_{14} , and D_{24} (in red); and (c) The lowest MD is the MD between A and B, *i.e.*, MD_{AB} is D_{13} .

The MDs of each static obstacle are computed with the other obstacles. If an MD is smaller than a given dimension, then it indicates a bottleneck (*i.e.*, the user with the given size cannot pass). In this manner, all of the bottlenecks between the obstacles are collected (see Figure 5.10).

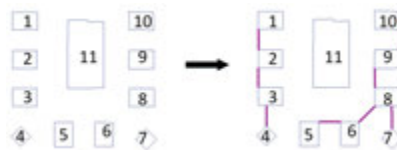

FIGURE 5.10 Bottleneck detection between obstacles. The thick lines indicate the bottlenecks.

Figure 5.10 presents bottlenecks between obstacles for the user with a given size. The bottlenecks are denoted with the lines linking the convex hulls (CH for short) of obstacles (see Figure 5.10). If an obstacle has no bottleneck with the other obstacles, then the obstacle is an individual group (e.g., Obstacle 11). Otherwise, the obstacles that 'connect' to each other by these lines are put into the same group (e.g., Obstacles 1–4).

§ 5.2.4 Group obstacles

This section introduces the method for grouping obstacles by using the MD between them. Obstacles with bottlenecks (*i.e.*, the MDs are smaller than a user's size) are put into a group. A linked list is created for each obstacle. Each bottleneck between two obstacles is regarded as a connection of them. The linked list contains all of the other connected obstacles. The following steps illustrate the process (see Figure 5.11).

- Step 1. Pick an unchecked obstacle as the current obstacle 'obs'. If there is no unchecked obstacle, then go to Step 5. Otherwise, create an empty group 'gop'; add obs to gop; and go to Step 2.
- Step 2. In the linked list of obs, add all of the unchecked members within the distance to gop.
- Step 3. For the previously added members, add all of the unchecked members in their linked lists to the gop.
- Step 4. Repeat Step 3 until no unchecked members are found. Then, the obstacles in the gop form a group. Go to Step 1.
- Step 5. All of the groups have been identified. Count the number of groups and assign each group an ID.

Figure 5.11 presents an example of grouping obstacles. The groups of obstacles are the actual obstacles for users with a given size. The user has to avoid any obstacle groups that can have different shapes. Accordingly, the boundary of every obstacle group needs to be generated, which will be addressed in Subsection 5.2.6.

§ 5.2.5 Select obstacle groups

This step is introduced to reduce the number of groups that will be used for path computation. Between two locations, some indoor objects may not interfere with the path for a user with a given size. Hence, it is necessary to ascertain the groups of obstacles that influence a path.

In a room, the shortest path is computed first between two locations without respect to the obstacles. The path is named the *direct path*. The *direct path* and CH of obstacles are employed to select obstacle groups. The selection process consists of the following steps:

- Step 1. Find the obstacles intersecting the *direct path*.

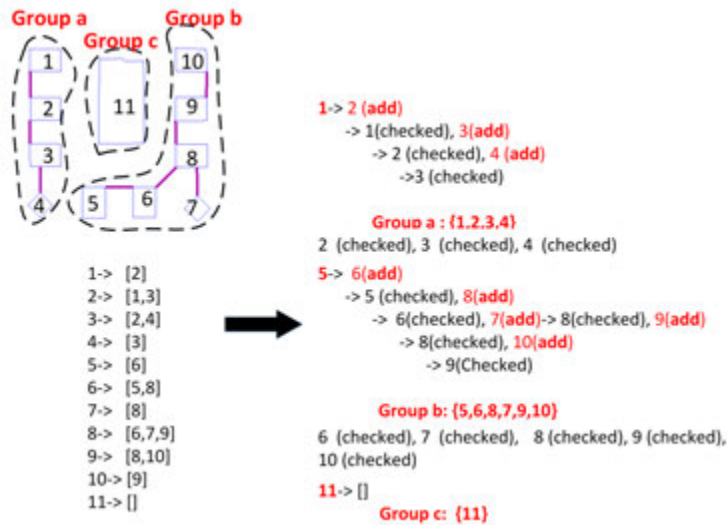

FIGURE 5.11 Grouping 11 obstacles into three groups with respect to bottlenecks.

- Step 2. Select all of the obstacles from the groups that have an obstacle intersecting the *direct path*.
- Step 3. Compute a *CH* with the nodes of all of the selected obstacles and the *direct path*.
- Step 4. If the current *CH* intersects or contains new obstacles, look up the groups of the new obstacles, and select all of the obstacles from the new groups. Re-compute a *CH*.
- Step 5. Iterate Step 4 until there are no other obstacles included by the current *CH*.

The obstacle selection aims to choose obstacle groups in a limited region for path finding. The iterative procedure will stop when the *final CH* (*FCH* for short) does not include any new obstacle. For a user with a given size, the shortest path in the VG can be found in the *FCH* or the bound of the *FCH* (see Lemma 2 and 3 in Appendix A).

To ensure the correctness of the above algorithm, three Lemmas are introduced whose proof can be found in Appendix A:

- **Lemma 1** If a polygon contains some indoor static obstacles, then the polygon also contains all visibility edges of the VG derived with these obstacles.
- **Lemma 2** Given a user size, related grouped obstacles, and the start and target in a space, if a computed *FCH* does not intersect exterior obstacles, then the shortest path from the start to the target is either inside or in the bound of the *FCH*.
- **Lemma 3** Given a user size, related grouped obstacles, and the start and target in a space, the real shortest path from the start to the target is the shortest path derived in the VG of the obstacles in the *FCH*.

Lemma 1 indicates a *CH* (polygon) contains the whole *VG* among the obstacles in the *CH*. *Lemma 1* is the base for *Lemma 2*; *Lemma 2* ensures the shortest path inside or in the bound of the *FCH*; and *Lemma 3* ensures that the shortest path derived from the *FCH* is the real shortest path among all the obstacles for the given size of user.

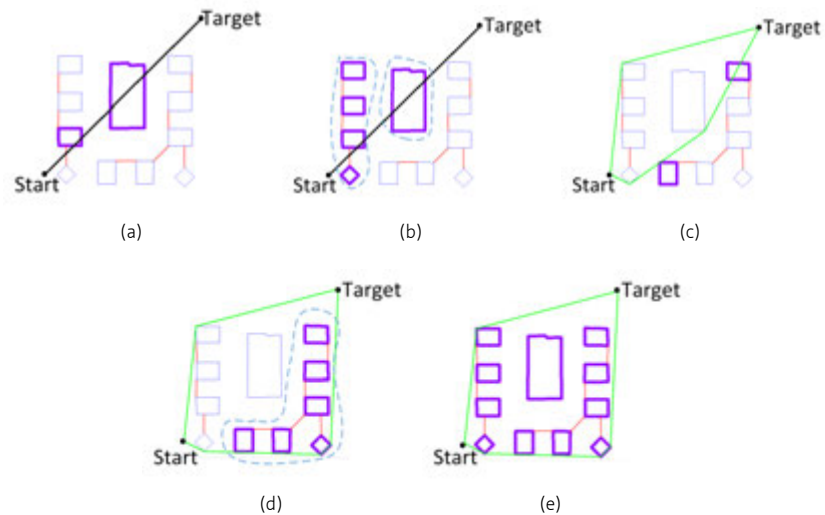

FIGURE 5.12 Selection of obstacle groups with respect to the start and the target location of a user. (a) The direct path intersects two obstacles; (b) Groups of the intersected obstacles; (c) A convex hull (CH) of obstacles and the CH intersecting other obstacles; (d) Groups of new obstacles and the new CH; and (e) The final CH with three selected groups.

Figure 5.12 illustrates the selection process. The obstacles have been grouped according to a given dimension of users. A *direct path* is computed between two locations. First, the *direct path* intersects two obstacles (Step 1). The two obstacles belong to two different groups; second, all of the obstacles in the two groups are selected (Step 2); third, a *CH* is computed with the selected obstacles (Step 3). Then, the *CH* intersects two new obstacles; fourth, the group of the two new obstacles is found. All of the obstacles in the group are selected, and then, a new *CH* is computed (Step 4); finally, the new *CH* has no other intersections (Step 5). Thus, the *CH* is the *FCH*, and the three groups of obstacles are selected. The extreme case is that all of the obstacles in a room are selected in the *FCH*. This means that all of the obstacles will be used for path computation. This case may happen in an obstacle-dense scenario. Large sizes of humans and equipment can also result in the extreme case. But in common indoor scenarios only some of the obstacles in a room are selected, especially in a large room/hall where a user just needs to pass through part of the room from the start to the target location.

§ 5.2.6 Create boundaries for selected groups

This section presents the generation of non-overlapping boundaries for the selected obstacle groups. The *alpha shapes* [EM94, AEF⁺95] method can be employed to compute non-convex boundaries of a point set. In the 2D plane, the *alpha shapes* of a point set are different polygons formed by this point set. Each alpha shape (*i.e.*, a polygon) is determined by a value (*i.e.*, the alpha value). The *alpha shape* is the *CH* when the alpha value approaches infinity, and it becomes the set of points when the alpha value equals zero [EM94]. Other alpha values in between zero and infinity correspond to a number of non-convex polygons of the point set. The *alpha shape* method is adopted to compute non-convex boundaries for obstacle groups, which ensures separate boundaries for different groups of obstacles. Thus the boundary of an obstacle group is an *alpha shape* of the vertices of all the obstacles in the group.

A common method [EM94] is used to compute alpha shapes by employing *Delaunay Triangulation (DT)* [dBCvKO08]. For the set of points P , the *DT* is a decomposition consisting of a set of triangles in which there is no other point inside the circumcircle of each triangle [dBCvKO08]. Based on the *DT*, the *alpha test* results in the *alpha shape* by using an alpha value: for each triangle in the *DT*, if the length of every edge in the triangle is shorter than the alpha value, then the triangle needs to be preserved; otherwise, the triangle will be removed. The boundary of the union of all the preserved triangles forms the *alpha shape*.

The *alpha shape* is computed based on the alpha value equal to the given size of a user. As a result, there is only one *alpha shape* (*i.e.*, the boundary) for the user. This method generates non-overlapping boundaries of all the obstacle groups (see Figure 5.13). The procedure for boundary generation is presented below:



FIGURE 5.13 Non-overlapping boundaries of obstacle groups. The brown polygons are the generated boundaries.

- Step 1. For a selected obstacle group, check the number of obstacles. If the group includes only one obstacle, then the obstacle's polygon is the boundary. Otherwise, go on to Step 2.

- Step 2. Create a *DT* with the vertices of all the obstacles in the group, and assign the given size of the user to the alpha value.
- Step 3. Compute all of the lengths of the edges of each triangle in the *DT*. Preserve a triangle if its edges' lengths are all smaller than the alpha value.
- Step 4. In all of the preserved triangles, find the edges only used for one triangle (*i.e.*, other edges shared with two triangles are interior edges). Form the edges into a boundary.

Three groups of obstacles are shown in Figure 5.14. The boundaries are derived in the same number of obstacle groups. The alpha value is set to the user size 0.8 meter (m). At first, two groups' *DTs* overlap. After the alpha test has been applied to the *DTs*, non-overlapping boundaries are computed for the groups.

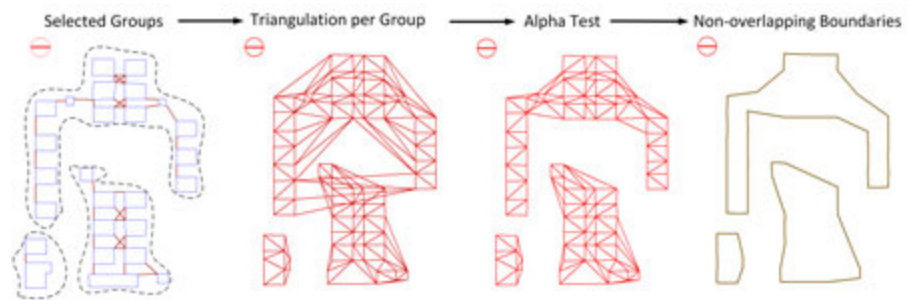

FIGURE 5.14 Boundary generation of three obstacle groups for a user with size 0.8m.

§ 5.2.7 Compute the MD between the boundaries of the obstacle group and walls

There are two possibilities for paths. Paths can be found either in the gaps between the groups of obstacles or the gaps between obstacles and walls of a space. If such a path is not found, this space cannot be passed by a user with this size.

Similar to the bottlenecks between obstacles, bottlenecks are also defined for a wall as the inaccessible gap between the wall and the boundary of an obstacle group. For a user with a given size, bottlenecks are detected for walls by using the buffer of a space (see Figure 5.15). The buffer is computed with the offset value equal to the user's width. In the selected obstacle groups, if a node of the boundary is inside the buffer, then a perpendicular line is derived for the wall (see Figure 5.15). The perpendicular line represents the bottleneck (*i.e.*, not possible to pass through) for the wall.

§ 5.2.8 Create a VG considering inaccessible gaps with walls

For a user with a given size, a VG can be created in a space with the boundaries of the selected obstacle groups. The edges crossing the bottlenecks to the walls are inaccessible to the user (see Figure 5.15). The edges should be removed for path computation.

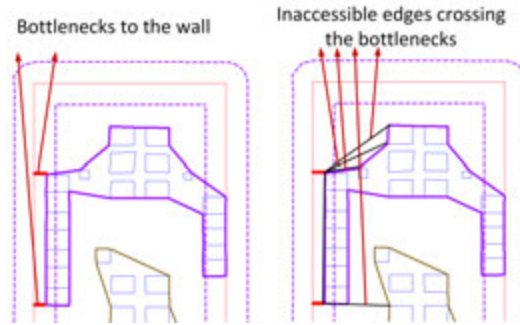

FIGURE 5.15 Bottleneck detection between a wall and the boundary of an obstacle group and identifying inaccessible edges crossing the bottlenecks.

The VG is adopted to compute geometric edges. Figure 5.16 illustrates the creation of a VG and presents the shortest path between two locations for users of 0.8 m. First, the VG is created with the nodes of three selected group boundaries (see Figure 5.16a). Second, a buffer of the space is computed, and the three boundaries overlap the buffer (see Figure 5.16b). Third, all of the bottlenecks between the boundaries and walls are found (see Figure 5.16c). Consequently, the inaccessible visibility edges are located. Fourth, the inaccessible visibility edges are removed (see Figure 5.16d). Finally, the shortest path (see Figure 5.16e) is computed in the VG. A user with the given size can follow the path. As addressed in Section 5.1, though the computed path touches corners of obstacles (Figure 5.16e), the schematic visualization of geometric edges is used instead of precise trails for a user, *i.e.*, the form derived from the above VG.

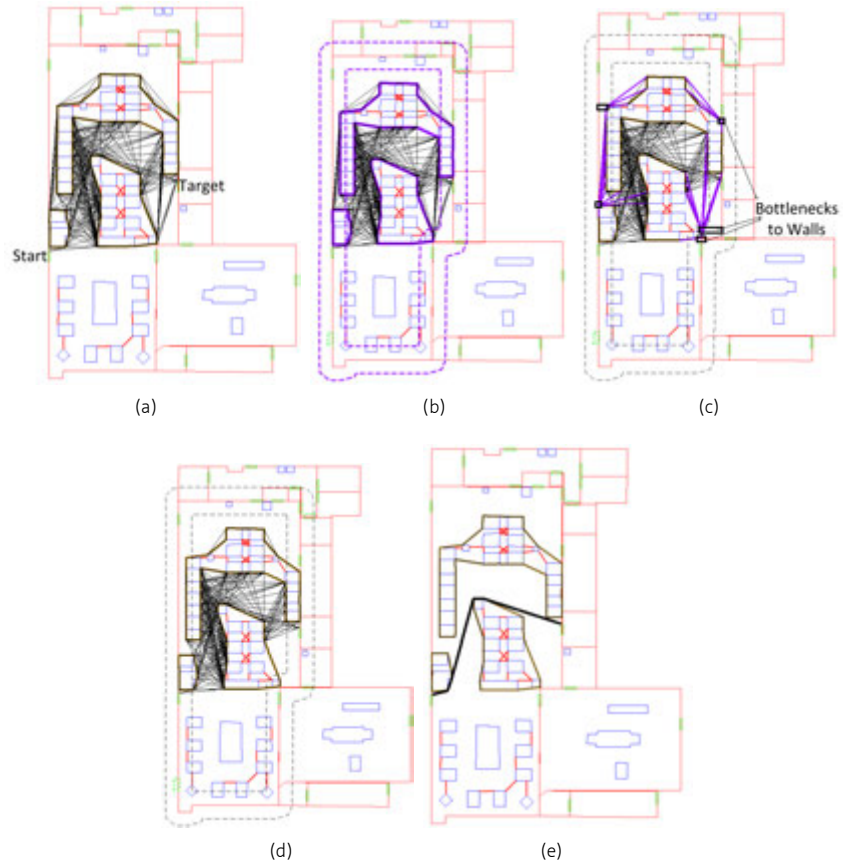

FIGURE 5.16 A visibility graph (VG) and a space buffer. Inaccessible edges are removed and a path is computed for users with size 0.8m. (a) The VG; (b) Space buffer; (c) Inaccessible edges in the bottlenecks; (d) The VG without inaccessible edges; and (e) The computed geometric edge.

§ 5.2.9 Network from edges

The above approach is used to generate geometric edges for users with different sizes. For each given user size the proposed approach is employed to compute all of the shortest paths among the doors/POIs in a space (see Figure 5.19). These shortest paths (e.g., geometric edges) form the geometric network for the given user.

A geometric network can be derived in a space. Given a user size, the proposed approach is iterated for every pair of start and target doors/POIs in a space:

1. For all obstacles, conduct the first two steps 'Compute MD between obstacles and find inaccessible gaps' and 'Group obstacles'.
2. Iterate the third step 'Select obstacle groups' for each pair of start and target, and record all the groups selected with each pair of start and target. Then the union of all these selected obstacle groups is used to compute the geometric network in the space.
3. Apply the fourth step 'Create boundaries for selected groups' for the above obstacle groups.
4. On the above obstacle groups, conduct the fifth step 'Compute the MD between the boundaries of the obstacle group and walls'.
5. Derive a VG for routing by the final step 'Create a VG considering inaccessible gaps with walls'.
6. In this VG compute all the shortest paths among all the pairs of doors/POIs in the space for the given user size. These paths form the geometric network.

Obstacle groups selected with each pair of start and target is the subset of all the obstacle groups. According to *Lemma 3* (see Appendix A), given a start and a target and a user size, the shortest path (i.e., geometric edge) can be computed with the selected obstacle groups. Therefore, the above process can ensure geometric edges for the geometric network in this space.

In the above process, unrelated obstacle groups are excluded for VG generation by the iteration of 'Select obstacle groups' for each pair of start and target. But in some cases (e.g., very large user sizes and a few obstacle groups), the iteration may select all the obstacle groups in the space. In such cases, the iteration would stop, and immediately go to the next step ('Create boundaries for selected groups') with all the obstacle groups in the space.

Based on the derived VG, all the geometric edges between the doors can be computed in this space. Figure 5.17 gives an example of geometric networks for a space. Figure 5.17a presents a geometric network between doors for a user with size 0.6m. In Figure 5.17b, two POIs (in red) are specified and added by the user and another geometric network is computed that consists of edges among the doors and POIs. One can find that the two POIs significantly change the geometric network regarding only doors (Figure 5.17a). Once the POI changes, the geometric network needs to be re-generated. Therefore, it is not necessary to store geometric networks when POIs are frequently added and/or deleted.

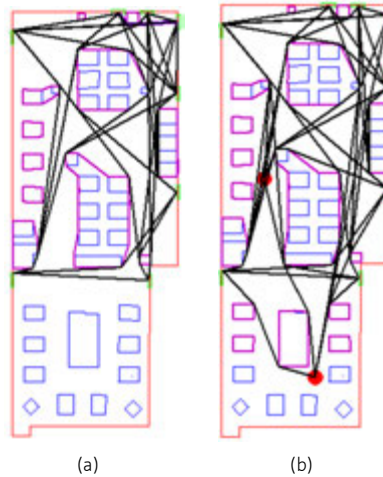

FIGURE 5.17 Example of geometric networks for a space. The user size is 0.6m. (a) A geometric network between doors; and (b) A geometric network among doors and POIs (two red dots).

The proposed approach is also used to form a geometric network for a number of spaces. As addressed before, this research focuses on navigational functions of indoor spaces, *i.e.*, to find indoor paths by considering different space choices. In this sense, routing criteria for the selection of spaces (see Chapter 4) are prior to the geometric criteria (*i.e.*, the shortest distance). Therefore, in this thesis a geometric network is the combination of all the subnetworks in the given spaces.

Two spaces are connected via specific doors. According to the sequence of spaces, the sequence of doors can be confirmed. Then in each space the geometric network is generated according to the related doors. For example, Figure 5.18 presents a geometric network for the user size 0.6m in a sequence of spaces. Figure 5.18a shows the space sequence is $S1-S2-S3-S4$. The highlighted doors are geometric nodes. The sequence of doors is $D1-D2-[D3,D4]-D5$ which depends on the space sequence. In the space $S2$, there are two geometric edges from $D2$: $D2-D3$ and $D2-D4$; in the space $S3$, there are two geometric edges to $D5$, *i.e.*, $D3-D5$ and $D4-D5$. To construct this geometric network, five obstacle groups are selected in $S1$ and $S2$ (see Figure 5.18b). The geometric edges between doors for the given size can be stored to be reused when the same space sequence is frequently used for logical paths.

§ 5.2.10 Geometric network for users with changing sizes

The computed geometric networks contain only edges that can be followed by a specific user. As mentioned before, doors for the geometric networks are the same. However, if there is not any accessible path starting from or leading to a door node, then this node can be removed from the geometric network since it is isolated.

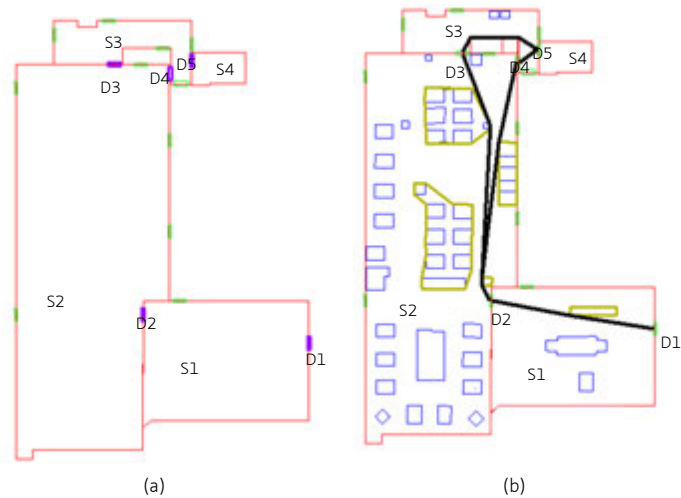

FIGURE 5.18 A geometric network for a sequence of spaces. The user size is 0.6m. (a) The space sequence and door sequence; and (b) The geometric network.

Regarding the same set of geometric nodes (doors) in a space, Figure 5.19 illustrates different edges for distinct user sizes. Figure 5.19a presents the VG created with all the obstacles without a user size. It is visible that VG has too many edges, which will influence the computational performance. The geometric networks (Figure 5.19b–d) consist of the shortest paths among the doors, and they are computed for the users with the sizes 0.5 m, 0.6 m, 0.8 m, respectively. For other users with the given sizes, geometric networks can be immediately created in the space. Moreover, the inaccessibility among doors can be recorded and be reported to the users. For instance, there is no geometric edge between the doors $D2$ and $D8$ for users of 0.8m (Figure 5.19d), but geometric edges between the two doors exist for users of 0.5m and 0.6m (Figure 5.19b-c).

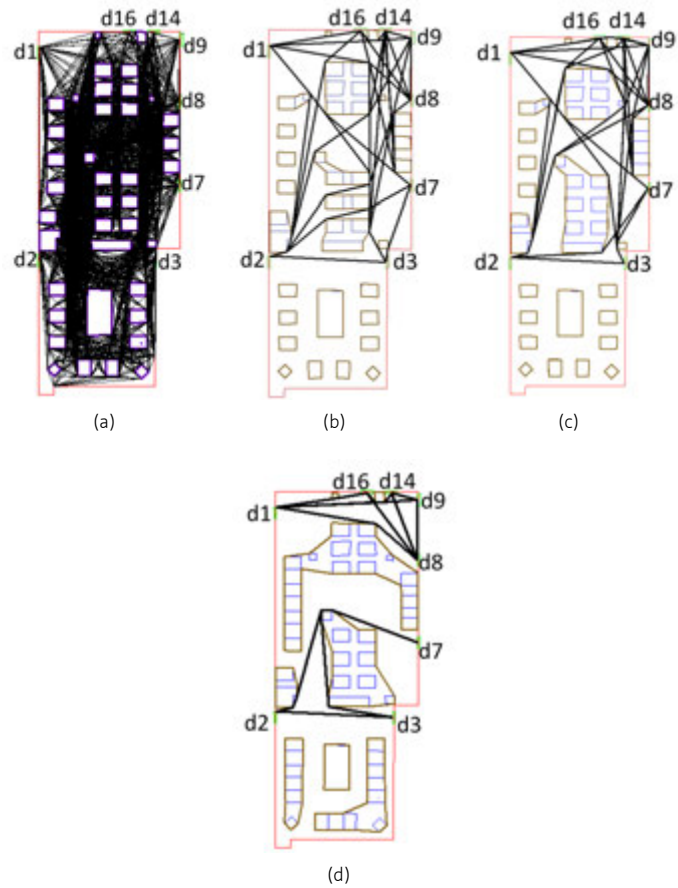

FIGURE 5.19 Geometric networks for different user sizes. (a) A complete VG regardless of a user's size; (b) The geometric network for size 0.5 m; (c) The geometric network for size 0.6 m; and (d) The geometric network for size 0.8 m.

Generally the geometric network of the larger size can be re-used in those of smaller sizes. For example, the geometric network of 0.8m can be computed and stored, and then edges of this network can be added to the geometric network of 0.6m or 0.5m.

The geometric networks can be maintained in a database and used according to path requests. The user can also be informed if no path exists. The accessibility information can even be recorded as the attribute to each space and employed for users to estimate generally the possibilities to pass through certain spaces.

§ 5.3 Summary

This chapter elaborates on the generation of user-dedicated geometric networks, taking into account the size of the user. This chapter responds to the following research sub-question:

5. Which approach should be used to compute the exact geometric description of accessible paths according to the size of a user?

Accessible paths are computed on the geometric network for a given user. The generation of a geometric network is based on the *Visibility Graph (VG)* method [OW88, AW88], which is motivated in Section 5.1. Section 5.2 introduced the new method to derive accessible geometric edges for a user in a single space to avoid obstacles. This method includes the following steps: 1) compute the *minimum distance (MD)* between obstacles; 2) group obstacles according to inaccessible gaps; 3) select obstacle groups with the *Convex Hull* method; 4) create boundaries for selected groups; 5) compute the *MD* between obstacles and walls; and 6) create the *VG* considering all the inaccessible gaps and compute the geometric edge. All the geometric edges in a space form the geometric network for this space. The generation of a geometric network for a sequence of spaces is also illustrated.

Besides doors, this approach can be used to include POIs or other openings (e.g., windows) in the geometric network. The geometric network should be re-created before routing, when a user specifies a new POI or multiple ordered POIs. In this case, the network cannot be pre-stored since the POI was not known in advance.

Section 5.2 also presents the example of geometric networks for changing user sizes. These geometric networks contain the same set of geometric nodes but distinct edges. POI can be changed according to different users, but doors of a building are constant. Thus the edges between doors can be stored, and edges related to POI can be computed in real time. As the illustrated geometric networks are only in regard to doors, these networks can be pre-computed and stored for a user or computed on demand. For instance, the geometric network can also be generated when the user walks into the space.

To compute accessible paths between two locations at different spaces, a geometric network is created regarding a set of related spaces which can result from routing on the logical network. So far, routing on the logical and the geometric network has been

thoroughly introduced. Chapter 6 and 7 will present the realization of the two-level routing approach.

6 Realization of one-level routing

Chapter 3 has introduced the design of the two-level routing approach, such as the definitions of logical (abstract level) and geometric (detailed level) networks, the INSM data model that structures building data for routing, the logical and geometric networks and routing options using the two types of network. Chapter 4 and 5 have elaborated the routing procedures and algorithms on the logical and the geometric networks, respectively.

This chapter presents an assessment based on the realization of the proposed concepts. Section 6.1 introduces the adopted software tools, building data and user-related information in a profile. Section 6.2 introduces the generation of the INSM from the used datasets, including the mapping procedure of the INSM from photographic or digital floor plans, IFC and CityGML LoD4 models. Section 6.3 presents tests of the routing on the logical and the geometric networks of buildings independently, which are named *logical routing* and *geometric routing*. Either of them uses just one type of network for routing, thus *logical routing* and *geometric routing* are regarded as *one-level routing*. Chapter 7 will address integrated two-level routing. Tests of *logical routing* illustrate the implementation of three typical criteria: *Floor strategy*, *Minimum NavigableUnit (NU)* and *Central HorizontalConnector (HC)*; tests of *geometric routing* show the following results: 1) for different users; 2) the same user with changing sizes; and 3) the generation of a large geometric network from the ones in each space considering POIs and different user sizes.

Section 6.4 discusses the test results, explains the main use of *INSMs*, and indicates possible extensions of *logical routing* and *geometric routing*. This chapter closes with some concluding remarks in Section 6.5.

§ 6.1 Software, data, and user profiles

The software and tools used in this research include *MicroStation V8i of Bentley Systems* [Sys16c], *Visual Studio 10.0* and *igraph* (an open-sourced *Python* package) [ict16] for graph computation and visualization. *MicroStation* is Computer Aided Design (CAD) software which makes it possible to digitalize photographic building data and to visualize routing results. *MicroStation* provides SDK for secondary development to customize functions. The *NativeCode* method is used, *i.e.*, to compile C or C++ source files with *MicroStation/Windows* resource files and then generate executable applications. The *NativeCode* method has a better performance in computation-intensive tasks compared to *MicroStation BASIC* applications, and it can make use of debugging functionalities in the *Microsoft Visual Studio 10.0* environment.

One desktop application with integrated functionalities (*e.g.*, network creation and routing) is developed in *MicroStation*. It supports the creation of a logical network, helps to derive geometric networks 'on the fly', and conducts logical and geometric routing according to user information and preferences (*e.g.*, *SpaceOfInterests* and *PointOfInterests*). Another application developed with the *igraph* package is used to compute

and visualize logical paths. Logical paths are also visualized in the desktop application as a sequence of spaces. Geometric paths are computed and visualized as polylines in selected spaces in the *MicroStation* application.

The general steps are presented as follows:

- First the *INSM* of a building is created in *MircoStation V8i*;
- Within *Visual Studio 10.0*, logical networks are created and are enriched with the *INSM* semantics;
- Logical paths are computed for users and visualized with *igraph*;
- Geometric networks are created for users, and geometric paths are computed and visualized in *MircoStation V8i*.

As mentioned before, the *Dijkstra* algorithm [Dij59] is adopted for routing on logical and geometric networks. Three groups of routing test are performed:

- Routing just on the logical network, *i.e.*, *logical routing*. For routing with multiple criteria, the computation adopts the workflow of routing with a priority ordering of criteria (see Chapter 4). In the following experiments, the priority order of criteria was decided according to specification in user profiles.
- Routing just on the geometric network, *i.e.*, *geometric routing*. To create a geometric network for a specific user, steps presented in Chapter 5 were implemented including computing minimum distances (MD), grouping obstacles, creating group boundaries and creating VGs. Full steps were implemented by C++ language in the *Visual Studio 10.0* environment.
- Two-level routing, based on both logical and geometric networks. This is tested in the desktop and a mobile application which will be elaborated in Chapter 7.

§ 6.1.1 Data Preparation

This chapter presents tests in the desktop application for the assessment of one-level routing (*i.e.*, to use one single type of network for routing). The first step is data preparation. The input data is *INSMs* from which logical and geometric networks can be created automatically. As mentioned before, *INSM* is a data model for storage and management of indoor spaces whose geometry can be denoted by 3D volumes or surfaces. In this thesis, an *INSM* is referred to as 3D floor plans with the *INSM* semantics stored in different *MicroStation* layers. The geometry of indoor spaces is represented by 3D surfaces (*e.g.*, stairs extended in vertical directions). Specifically, horizontal spaces are abstracted as flat polygons (in 3D space but without vertical walls) and vertical passages are symbolically represented by 3D polygons (reflecting boundaries).

In reality, datasets organized according to an *INSM* are not directly available. The most commonly available data source of buildings is floor plans (*e.g.*, images of evacuation plans or architectural plans) in paper-based or digital form. 3D building models, such as *BIM IFC* and *CityGML LoD4*, include rich geometric details. They can be used for

indoor navigation. This chapter presents the mapping from such data sources to an *INSM*. Three types of data source are used:

1. no vector geometry and semantics of spaces (*i.e.*, photographic floor plans);
2. no dedicated geometry for indoor spaces (*i.e.*, architecture plans);
3. with 3D geometry and semantics of indoor spaces (*i.e.*, *IFC* and *CityGML LoD4*), but no navigational semantics.

For the first type, the spaces and attached semantics are created manually. In the second type, digital architecture plans contain many lines and line strings to represent building elements but most of them are not closed. Thus, these spaces are manually closed and the original semantics is kept, such as *Wall*, *Space*, *Door*, *Window*, *Stair*, and so on. Work [Wu15] related to this thesis presents semi-automation for reconstructing 3D building models from architectural plans, which should comply with certain rules. More research by Dominguez-Martin *et al.* [DMvOFH⁺15] presents the automation of building reconstruction with geometry at a non-refined level. This reconstruction result still cannot be as detailed as a complete geometric representation of the building. Besides, it does not provide semantics for indoor navigation. Therefore, it is difficult to automatically generate either 3D models or just 2D topologically clean floor plans (*e.g.*, polygons with topology and semantics) from architectural plans.

The ideal group of input data is *IFC* and *CityGML LoD4* models. The geometry of horizontal spaces in *IFC* is solid, but they are not directly used. Instead, only the accessible surface (*e.g.*, ground surfaces) of a solid is used. Some vertical passages such as stairs are represented by a composite of solids (steps), which impedes the automatic abstraction of walkable surfaces. The floor surfaces of horizontal spaces are automatically abstracted, but surfaces representing vertical passages are manually created. For a *CityGML* model, spaces are also denoted by surfaces, which can be easily extracted. But the geometry of spaces is extended manually to create space semantics.

Tests of *logical routing* and *geometric routing* are implemented based on four photographic floor plans, one digital architecture plan, one *IFC* building model and one *CityGML LoD4* model.

Photographic floor plans (the first type of data) are listed as follows:

- The image of *Schiphol Airport*, the Netherlands (Figure 6.1a). This image is downloaded in the webpage of the airport [Ams15]. It contains *Stairs*, *Elevators* and *Escalators*.
- The images of the 22, 23 and 24 floors of the *Vermeertoren* building, Delft, the Netherlands (Figure 6.1b). It contains *Stairs* and *Elevators*. The three floors share the same configuration and they are represented by the same image (Figure 6.1b). The image is accessed at: [http://www.vermeertoren.nl/media/Vestia/nl_NL/Documents/Product ion_documents/Binnenwerk.pdf](http://www.vermeertoren.nl/media/Vestia/nl_NL/Documents/Product%20ion_documents/Binnenwerk.pdf)
- The image of the first floor of the *Museum of Fine Arts (MFA)*, Boston, USA (Figure 6.1c). *Stairs* and *Elevators* related to this floor are included but not used, because this plan is used to test routing on only one floor. The image is accessed at: <http://www.mfa.org/visit/plan-your-visit/floorplans>.
- The image of the floor plan of a *conventional neonatal intensive care unit (CNICU)* at Sanford Children's Hospital, USA (Figure 6.1d). *Stairs* and *Elevators* are not included because it is only for tests on this floor. This image is from the literature [SAKM⁺07].

The floor plans of *Schiphol Airport*, which is adopted as a complex building, include large irregular shaped spaces with many obstacles (see 6.1a). The building of the *Vermeertoren* in Delft contains many doors and it is a typical residential building. The first floor of the *MFA* includes many spaces and many of them are passages (see Figure 6.1c), which is a typical case to test multiple paths between two spaces on a floor. The *CNICU* contains many obstacles (see Figure 6.1d), so it is suitable for testing the proposed approach that computes geometric paths regarding user sizes among doors/POIs in single spaces.

A digital architecture plan (the second type of data) is listed as follows:

- The architecture plan of the ground floor of the *Architecture Faculty building 'BK'* at Delft University of Technology, the Netherlands (Figure 6.1e). It is a vector-based plan provided as a CAD file, and the data is authorized by the Map Room of this faculty. This plan is used to test routing on a single floor, and *Stairs* and *Elevators* are not included.

The ground floor of the BK building includes considerable indoor spaces and some of them contain a number of obstacles (see Figure 6.1e). The lines and symbols of this architecture plan are converted into spaces to analyse the influence of user sizes on geometric paths, and to discuss the creation of geometric networks with respect to these spaces.

Two 3D semantically rich models (the third type of data) are used:

- An *IFC* design model of a residential building (Figure 6.1f) which is provided by *Bentley System Inc.*;
- A *CityGML LoD4* model of the old *OTB* building, Delft (Figure 6.1g) which is provided by the *OTB Department of Architecture Faculty*, Delft University of Technology.

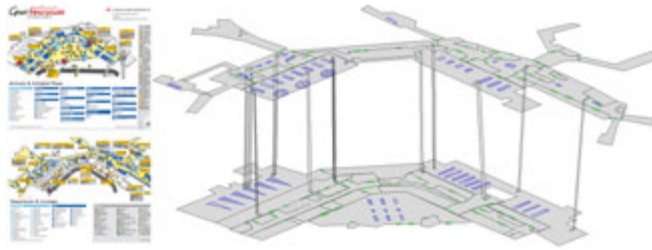

(a)

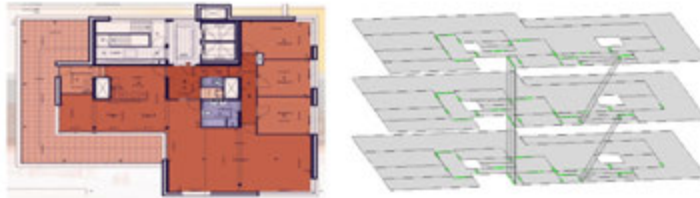

(b)



(c)



(d)

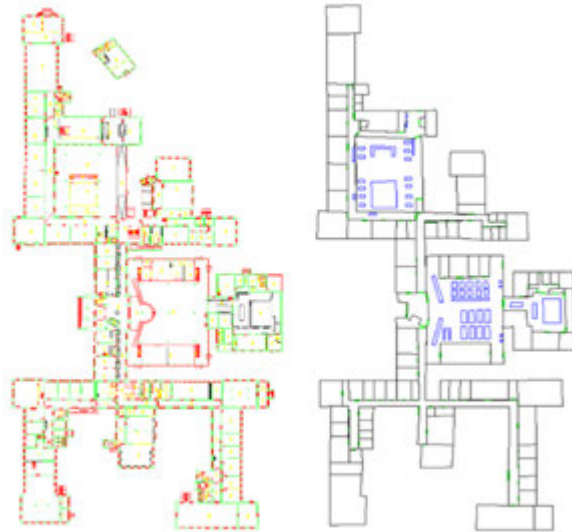

(e)

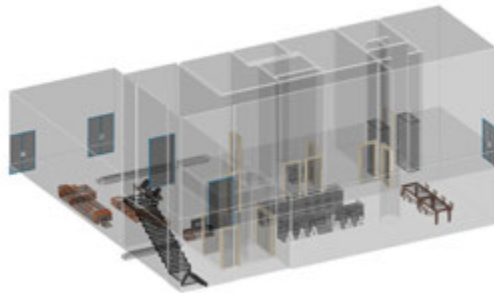

(f)

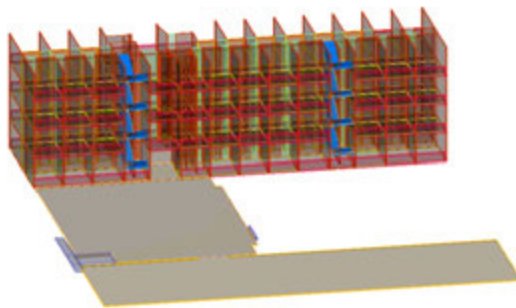

(g)

FIGURE 6.1 Images of input datasets and the corresponding INSM representations. (a) Schiphol Airport; (b) The Vermeertoren building; (c) The MFA museum; (d) The CNICU floor plan; (e) The ground floor of the BK building (raw plan and clean version for routing); (f) A residential building provided by Bentley System Inc.; and (g) The old OTB building.

The two datasets are selected mainly based on the following reasons: 1) the indoor spaces of the buildings are well defined; 2) *VerticalUnit(VU)* information is easy to obtain. Subclasses of *VU* (*Stair*, *Escalator* and *Elevator*) can be distinguished with corresponding classes of the *IFC* and *CityGML* formats.

The *IFC* model of the residential building is selected as a simple case that contains a few spaces and only one staircase (Figure 6.1f). As introduced in Chapter 2, the *IFC* 2.3x standard includes several hundred classes. With the residential model, only the basic *IFC* classes are needed to support the mapping to the *INSM*. Furthermore, the data amount of the building geometry is small, which ensures the building geometry can be loaded with logical and geometric networks into a mobile application in the later test (Chapter 7).

The *CityGML* *LoD4* model of the old *OTB* building (see Figure 6.1g) is adopted because it presents a typical office building that contains regular shaped offices and few obstacles. Each floor of the old *OTB* building has a similar configuration. The building contains one elevator and two stairs to change floors.

In the next part, a short name is given to all the above datasets: *BK* for the ground floor of the *BK* building at the Delft campus; *Schiphol Airport* for Schiphol Airport; *Vermeertoren* for the three floors of the Vermeertoren; *MFA* for the first floor of the MFA museum; *CNICU* for the CNICU at Sanford Children's Hospital; *Residence* for the residential house; *OTB* for the old *OTB* building.

§ 6.1.2 User Profile

To reflect the relationship between routing and users, user profiles are introduced and connected to *logical routing* and *geometric routing*. As this research does not aim to develop a comprehensive user profile, a simplified version of a user profile is used, including four essential parameters: *age*, *mobility*, *role* and *size* of a user. More parameters and a comprehensive description about the user profiles for indoor navigation can be found in the work of Heckmann *et al.* [HSB⁺05] and Tsetsos *et al.* [TAKH06].

It is assumed that users have distinct routing criteria for logical paths. The parameter *age* makes it possible to distinguish suitable *VUs* for different users. A child may not be allowed to take the *Escalator* alone, and an elderly person may tend to use the *Elevator* to save effort. The *mobility* also helps to decide on proper *VUs* for a user. For example, a *With-Wheel-Devices* user can be a wheelchair user or a member of the maintenance staff with a vehicle equipment. They both prefer the *Elevator* to switch floors. Another example is an *Effort-Saving-Motion* user who prefers the *Elevator/Escalator* rather than the *Stair*, because she/he does not plan to walk vertically. The parameter *role* of a user indicates the user's level of access permission. A *Visitor* can only visit public spaces, a *Maintenance-Worker* can access facility spaces (e.g., the electrical distribution room), but an *Administrator* can access all the indoor spaces of the building. The last parameter is the *size* of a user which reflects the dimension of the user. Values for these parameters considered in this thesis are listed below:

1. Age. Options: Child, Adult, Elderly Person.
2. Mobility. Options: Walking, With-Wheeled-Devices, Effort-Saving-Motion.

3. Role. Options: Visitor, Maintenance-Worker, Administrator.
4. Size. Options: values from a user.

TABLE 6.1 Combinations of parameters of a user's profile. The symbol '+' indicates the choice is available, and '-' means the combination is not applicable.

Age	Mobility			Role		
	Walking	With -Wheeled -Devices	Effort -Saving -Motion	Visitor	Maintenance -Worker	Administrator
Child	+	+	+	+	-	-
Adult	+	+	+	+	+	+
Elderly Person	+	+	+	+	-	+

Combinations of these parameters in a profile are listed in Table 6.1. As the preferences on logical paths are subjective to humans, only the assumed associations are presented between user profiles and the priorities of routing criteria. In this implementation, a user is allowed to specify her/his priority order.

The parameter size is used to compute accessible geometric paths for a given user. As mentioned in Chapter 5, different user sizes correspond to distinct geometric networks and paths. More details about the use of the size parameter will be introduced in Section 6.3.2.

§ 6.2 Generation of an INSM for tested data

This section shows the generation of an *INSM* with all the datasets presented above. Section 6.2.1 introduces the general procedure for *INSM* generation. Section 6.2.2 explains how to transform input data into an *INSM*. Based on the logical networks of a transformed *INSM*, Section 6.2.3 distinguishes between *complex* and *simple* buildings by using the ratio of *Connector* nodes to all the nodes of a logical network.

§ 6.2.1 General procedure

The generated data are stored in a *Bentley DGN* file (a *MicroStation* format) [Sys16c] that contains floor plans of a building with different semantics stored in *MicroStation* layers. For instance, a 'Space' layer contains the geometry of indoor horizontal spaces (i.e., *HorizontalUnit (HU)*), a 'VU' layer for vertical passages (i.e., *VUs*), and an 'Opening' layer stores all *Openings (OPN)* of the building. Similarly, the 'Obstacle' and 'POI' layers are designed for the classes *Obstacle (OBS)* and *PointOfInterest* in the *INSM*. Specifically, different subtypes of *VU* are clarified, i.e., *Stair*, *Escalator*, and *Elevator*.

This subsection elaborates on the transformation of raster image and vector-based floor plans, *IFC* and *CityGML LoD4* models to an *INSM*. Theoretically *INSM* can represent either 3D geometry (volumes) or 2D geometry (polygons in the 3D space) for indoor spaces. For tests in this research, polygons are adopted to represent spaces.

The transformation is based on the manual digitalization of non-digital materials (*i.e.*, *paper/image*) and semi-automatic geometric computations of digital materials. The general procedure of *INSM* generation includes ten steps, which are listed below:

1. Load an original dataset into *MicroStation V8i*.
2. Generate 2D/3D floor surfaces of *HorizontalUnit (HUs)* and *OPNs* as polygons. Create a new larger *OBS* when two or more *OBS* polygons overlap.
3. Add space semantics to the polygons, and store them in different *MicroStation* layers (*e.g.*, 'Space' and 'Door').
4. Create 3D polygons to represent vertical passages between different floors, assign the *VU* semantics to the polygons and store them in a *MicroStation* layer.
5. Add a *VerticalConnector (VC)* for each *VU*. As the *VC* is not available in the original building models, the geometry of the *VC* is manually created for each *VU*.
6. For two connected spaces with a void doorway, create polygon geometry and the *Door* semantics to this doorway. Store the polygon in the *Door* layer.
7. Ensure *Doors* and *Windows* overlap the corresponding spaces. Though there is no overlap between spaces of the *INSM*, this step is designed to support automatic detection of the connection of spaces.
8. Create *OBSs* as polygons and ensure every *OBS* is contained in a related space.
9. Generate *POIs* as points and store them in the *MicroStation* layer *POI*. *POI* can be manually selected, or be generated by input coordinates.
10. Assign the semantics of *HC* and *END* to *HU* spaces, according to their definitions in the *INSM*.

As building data are not acquired with accurate coordinates in the absolute systems (*e.g.*, the geographic coordinate systems), the created *INSM* only refers to local systems. Using the local coordinate systems would not impair the computation and visualization of the two-level routing results. The length of geometric paths can be compared in local coordinate systems. Alignment to outdoor coordinate systems is left to future work (see Chapter 1).

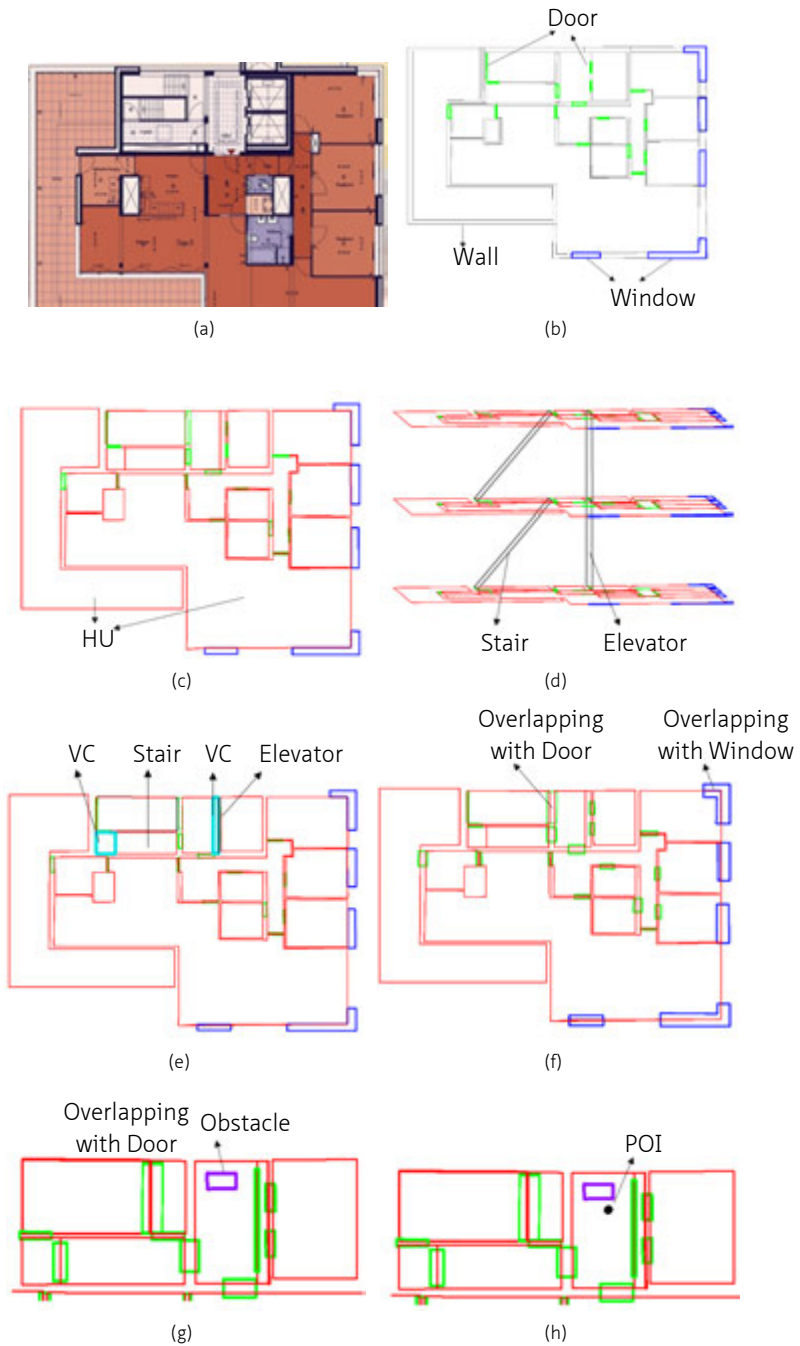

FIGURE 6.2 Vermeertoren. (a) Image; (b) Digitalized Doors (in green), Windows (in blue) and Walls (in black); (c) Navigable spaces such as HUs (in red); (d) VUs including Stairs (slope) and an Elevator (vertical polygon); (e) VCs neighbouring the VUs; (f) Doors and Windows are extended to overlap NUs; (g) OBSs (the purple polygon); and (h) POIs close to the OBSs (black dots).

§ 6.2.2 Transformation of the INSM from tested data

In this subsection three alternative data sources are used in the above proposed procedure to create content for the INSM: 1) floor plans; 2) IFC and 3) CityGML. Currently this procedure is semi-automated. At the end of this subsection, cases of full automation will be discussed.

Floor Plans

As mentioned previously, indoor spaces are manually created according to the *INSM* from floor plans. Given the *Vermeertoren* as an example, Figure 6.2 presents the whole mapping procedure of floor plans. In step 1 the image (JPG format) of the *Vermeertoren* is loaded (Figure 6.2a) in *MicroStation V8i*.

In Step 2, *Doors* (in green), *Windows* (in blue) and *Walls* (in black) are digitalized (Figure 6.2b). Based on the wall boundaries, *HUs* (Figure 6.2c) are created. In the implementation for this research, *Walls* are only used to locate the *HU* boundaries.

In Step 3, *HUs*, *Doors* and *Windows* are stored in *MicroStation* layers 'Space', 'Door' and 'Window', respectively (Figure 6.2b and 6.2c).

In Step 4, *VUs* are manually created in floor plans. Although the boundary of indoor spaces can be semi-automatically traced from architecture plans along with some rules [Wu15], *VUs* are difficult to be traced. According to the entrances of a staircase, it is symbolically created (*i.e.*, no actual steps) as a 3D polygon (Figure 6.2d) and stored in the 'VU' layer with the *Stair* attribute. Similarly, an elevator is created between two floors (Figure 6.2d), and it is put in the 'VU' layer with the *Elevator* attribute.

In Step 5, polygons with the *VC* semantics are manually created to link *VUs* (Figure 6.2e). The *VCs* are stored in the 'Space' layer with the *VC* attribute.

In Step 6, doorways are added between the *VC* and *Stair*, because they connect to each other but they have no physical doors. The doorways are put in the 'Door' layer with the 'Doorway' attribute.

In Step 7, *OPNs* (*e.g.*, *Doors*) are extended to overlap corresponding *HUs* (see Figure 6.2f). In this way, the connection between *HUs* and *OPNs* can be automatically detected, and the connectivity between *HUs* can be computed to generate a logical network. Note that this step is a temporary measure for automation purpose, and the subdivision of the building still results in indoor spaces without overlaps or gaps. In this test, the accurate building subdivision is kept.

In Step 8 two pillars are created as *OBSs* contained in two different *HUs* (Figure 6.2g). The *OBSs* are used in *geometric routing*.

In Step 9 a *POI* is specified close to the pillar (see Figure 6.2h), because the pillar is a salient object for users. In the *MicroStation* layer of 'POI', a user can add her/his preferred locations as *POIs* or provide coordinates to obtain this *POI* automatically.

In Step 10, *HUs* and *Ends* are distinguished automatically. From Step 1 to 9, the semantics of *HU*, *OPN*, *VU*, *OBS* and *POI* are obtained. However, for all the *HUs* in the



FIGURE 6.3 The automatic derivation of the *HC* semantics.

'Space' layer, their subtypes of *HC* and *End* are not differentiated. Based on their definitions, a simple procedure (see Figure 6.3) is used to assign the semantics of *End* and *HC* to polygons in the 'Space' layer.

IFC

The mapping of the *IFC* model to the *INSM* follows the general procedure (as that used for floor plans). Indoor spaces in the *IFC* model are separated solids. Instances of the *IfcSpace* are related to *NavigableUnit* (*NU*, including *HUs* and *VUs*), and instances of *IfcDoor* are related to *Doors* of the *INSM* (see Figure 6.4). The geometry of vertical passages (e.g., *IfcStair*) and *IfcDoor* is a composite of solids. As it is difficult to trace the accurate steps of *IfcStair* instances automatically, instances of *IfcStair* are converted to the ones of the *Stair* in the *INSM* (Figure 6.4). Figure 6.5 presents the generation of geometry of an *IfcStair* instance: the stair boundary is traced with a 3D polygon without steps, which would not influence routing directions. Figure 6.6 presents the *INSM* of *Residence*.

Compared to floor plans, the *IFC* model has different implementation details in Step 2. In Step 2, *HUs*, *OPNs* and *OBSs* in each floor can be automatically derived (see Figure 6.4). This automation requires only several *IFC* classes such as *IfcSpace*, *IfcDoor*, and *IfcFurnishingElement*. The *IfcSpace* and *IfcDoor* correspond to the classes of *NU* and *Door* in the *INSM*, respectively. The *IfcFurnishingElement* is related to *OBS* in the *INSM*. The geometry of *IfcSpace* is a simple solid, but *IfcDoors* and *IfcFurniture* contain a collection of different solids. In *MicroStation* the following surfaces are extracted: the bottom surfaces of *IfcSpace* instances and the bounding boxes of *IfcDoor* and *IfcFurniture* instances. These extracted surfaces are put in layers of *NUs*, *Doors*, and *OBSs*, respectively. When surfaces of *OBSs* (e.g., a desk and chairs around it) overlap, they are merged into a larger one (e.g., the far right red polygon in Figure 6.6).

In Step 6, besides doorways between the *VC* and *Stair*, doorways are also added between the connected *HUs*. In the original dataset, two *IfcSpace* instances are connected without an *IfcDoor* instance in between them (Figure 6.7a). This problem results from the subdivision of *Residence*: the two spaces represent the whole hall but they are separated in the dataset. Thus a doorway is generated between the two *HUs* after the *INSM* of *Residence* is created (Figure 6.7b).

CityGML

The *CityGML LoD4* model is mapped to the *INSM* following the general procedure presented previously. Figure 6.8 illustrates the mapping between *CityGML LoD4* and the *INSM*. Surfaces for *HU*, *OPN* and *OBS*, *Stair* and *Elevator* are manually created (Figure 6.9). According to the latest version v2.0.0 of *CityGML*, instances of *Room* can be

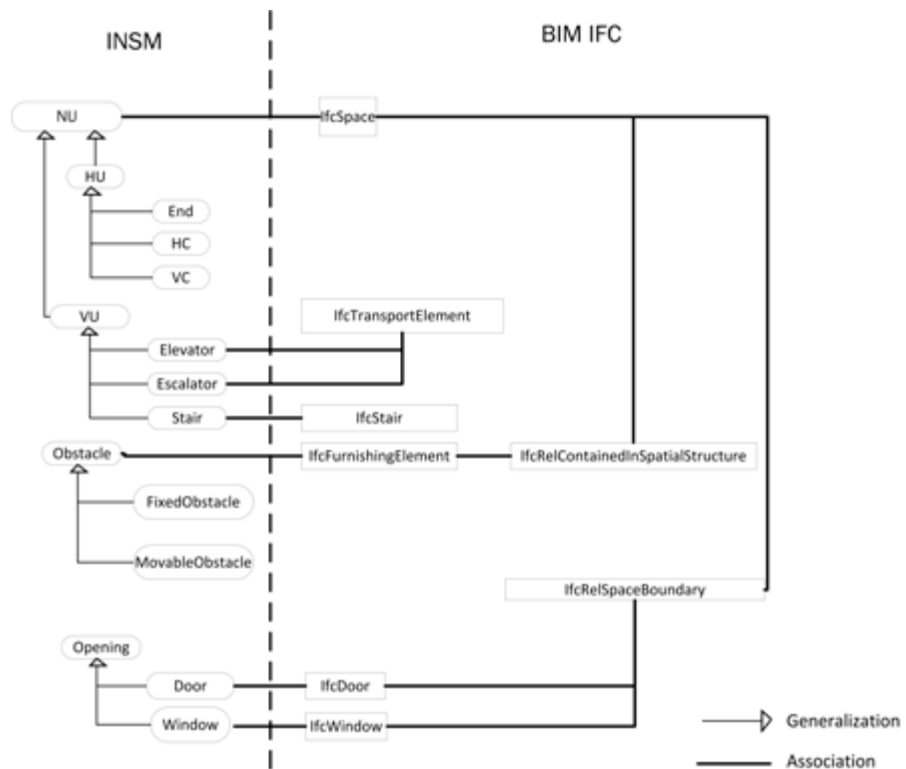

FIGURE 6.4 The associations between the IFC classes and INSM classes, i.e., the mapping of the two models.

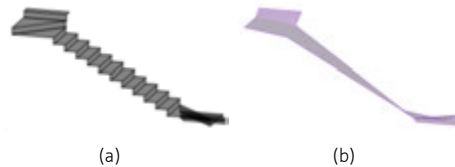

FIGURE 6.5 Creation of INSM geometry from an IfcStair instance. (a) The stair as a composite solid; and (b) The stair as a 3D polygon.

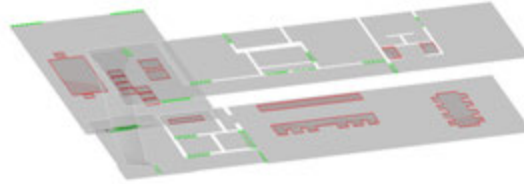

FIGURE 6.6 The INSM of *Residence*. Grey polygons represent *NUs*, green ones are *OPNs*, and red ones are *OBSs*.

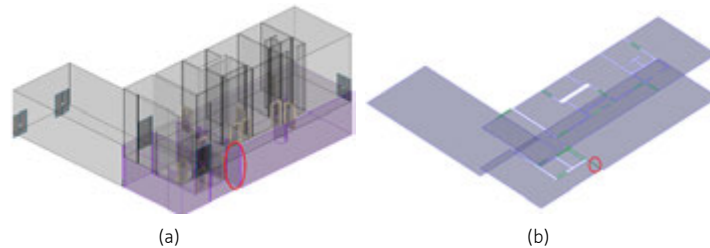

FIGURE 6.7 An example of a NO explicit door. (a) No *IfcDoor* instance between two *IfcSpace* instances; and (b) A *Doorway* is added.

mapped as either *HU* or *VU* based on the specified attribute values. In addition, *Int-BuildingInstallation* instances can be either an interior *stair* or an *OBS* (e.g., a fixed installation). Such 'Multiple-to-One' relationships usually complicate or impede an automation procedure to obtain surfaces of *HU*, *VU* and *OBS*. Thus the above spaces are manually created by copying the available geometry in the *CityGML* files.

Towards full automation of INSM generation

Although the automatic mapping is outside the scope of this research, some ideas for facilitating the automation are discussed. First, closed spaces with semantics should be automatically derived from architecture plans by applying some rules. In research [Wu15] related to this thesis, an initial automation is developed to trace closed spaces bounded by openings and their adjacent walls. In this method windows and doors of input floor plans are drawn, and the unnecessary details of the plans are cleaned manually. This method can recover indoor spaces for regular structured buildings, but re-drawing rules and multiple thresholds for the automation need to be specified manually based on specific scenarios. Another building reconstruction method designed by Dominguez-Martin *et al.* (2015) presents the automation of a building reconstruction with a part of geometric details [DMvOFH⁺15]. They take a CAD file in three views (top, front and side) as input, generate contours of the three views, and then extrude a volume (*i.e.*, space) from these contours. But this method still cannot reconstruct a complete geometric representation of building.

Second, intelligent use of semantics can help in the automatic mapping. As mentioned above, the mapping from *CityGML* to the *INSM* includes many 'multiple to one' cases

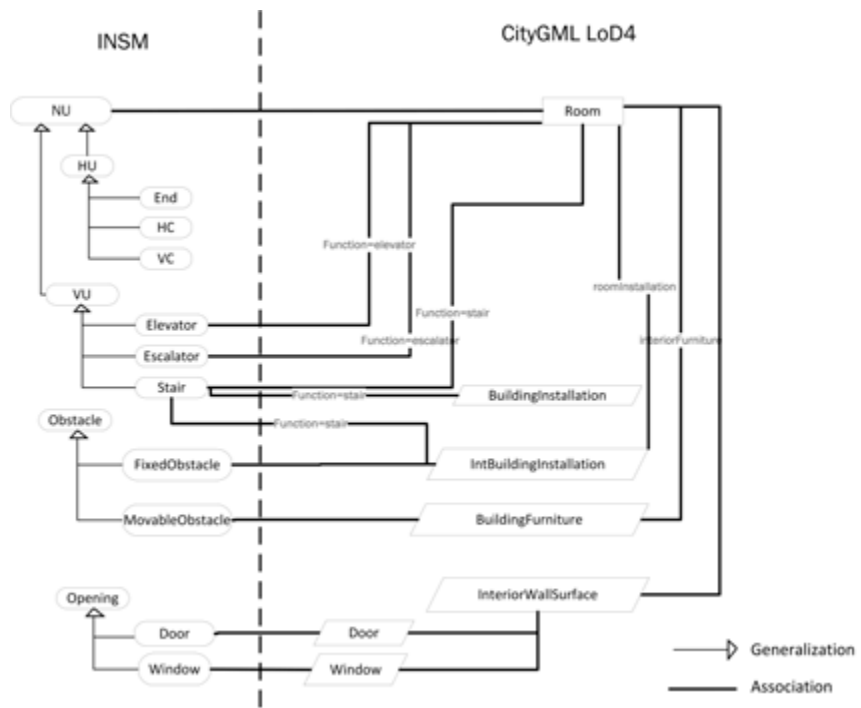

FIGURE 6.8 The conceptual mapping between CityGML and INSM.

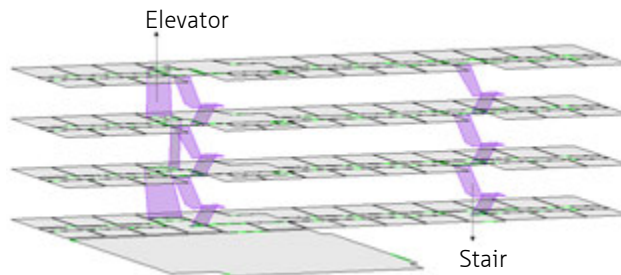

FIGURE 6.9 The INSM of the old OTB building. The stairs and the elevator are manually digitalized as 3D polygons.

(see Figure 6.8). For example, a *Room* instance of CityGML can be a *HU* or an *Elevator* in the *INSM*. When tags of *Room* instances are clearly attached by automatic classification based on certain rules (e.g., shapes or other geometric characteristics), an automation method can be developed for this mapping.

Third, the reconstruction of vertical passages in the three types of adopted data can be automated by approximating the geometry. For instance, it may be difficult to extract an accurate 3D surface automatically for vertical passages if the geometry of the vertical passage is represented by a composite of multiple surfaces (i.e., steps). An automation can be developed to fit a stair with several slopes, which omits steps of the stair as they are not important for routing. The geometry of an elevator in *IFC* or *CityGML* is represented by solid or multiple surfaces. In such a case, one of the wall surfaces of the elevator can be extracted automatically to represent the elevator.

§ 6.2.3 Estimation of the INSM complexity

For the coming tests, *complex* and *simple* buildings need to be distinguished, which reflects the complexity of their related *INSMs*. To define what is a relative *complex* or *simple* building, the distribution of node degrees of logical networks is computed and compared. As mentioned in Chapter 4, the degree of a node reflects the number of other connected nodes, and the logical network is a direct graph where one node has bi-directional degrees (*in-degree* and *out-degree*). A node with the total degree value 4 connects to two other nodes in the logical network, *i.e.*, *Connector*. The ratio of *Connector* nodes (degree ≥ 4) to all the nodes (*Connector ratio* for short) is calculated for a logical network. A high ratio indicates that many *Connectors* exist and may increase path choices between two locations in the building. In this sense, buildings with a high *Connector ratio* are regarded as *complex*.

TABLE 6.2 *Connector ratio* of logical networks for all the *INSMs*. *Schiphol Airport* has the highest ratio (35.79%) and *Residence* includes the lowest ratio (10.00%).

Building	Nodes more than 4 degrees	All nodes	Connector ratio (%)
Schiphol Airport	34	95	35.79
OTB	26	139	18.71
MFA	45	131	34.35
Residence	2	20	10.00
Vermeertoren	11	45	24.44
CNICU	3	13	23.08
BK	14	91	15.38

The *Connector ratio* is computed for logical networks of all the *INSMs*. *Schiphol Airport*, *OTB*, *MFA*, *Residence*, *Vermeertoren*, *CNICU* and *BK* contain ratios of 35.79%, 18.71%, 34.35%, 10.00%, 24.44%, 23.08% and 15.38%, respectively (see Table 6.2).

Then *complex* and *simple* buildings are defined based on the above results. A building is *complex* when its *Connector ratio* is higher than 30%; otherwise, the building is a *simple* one. As *Schiphol Airport* has the highest ratio (35.79%), it is regarded as the most *complex* of all the others. *MFA* is also considered *complex* with the second highest ratio (34.35%). The other buildings with low ratios (*Residence*, *OTB*, *Vermeertoren*, *CNICU* and *BK*) are regarded as *simple* buildings.

§ 6.3 Routing

§ 6.3.1 Logical network

This section discusses the implementation of routing on a logical network. Logical networks are created for two complex and three simple buildings: *MFA* (complex), *Schiphol Airport* (complex), *Residence* (simple), *OTB* (simple), and *Vermeertoren* (simple).

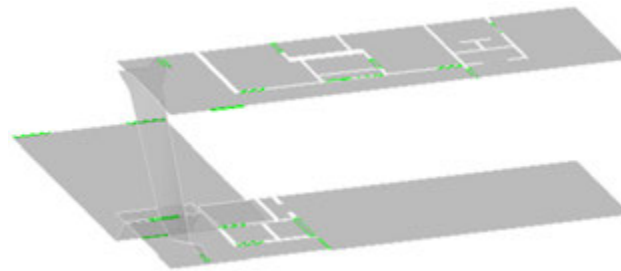

(a)

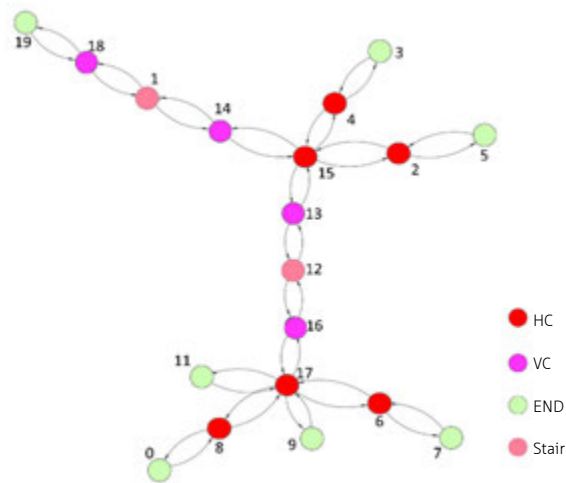

(b)

FIGURE 6.10 The logical network of *Residence*. (a) The INSM of *Residence*; and (b) The derived logical network.

Based on the *INSM* of *Residence* (Figure 6.10a), a logical network is derived automatically from the connectivity of spaces. *NU*s are connected when they all link to a *Door*. In addition, multiple *Doors* between two *NU*s are represented by only one logical edge. According to the definition of logical networks (see Chapter 3), the logical network is represented by a directional connectivity graph (see Figure 6.10b). The *INSM* semantics of nodes are differentiated in distinct colours.

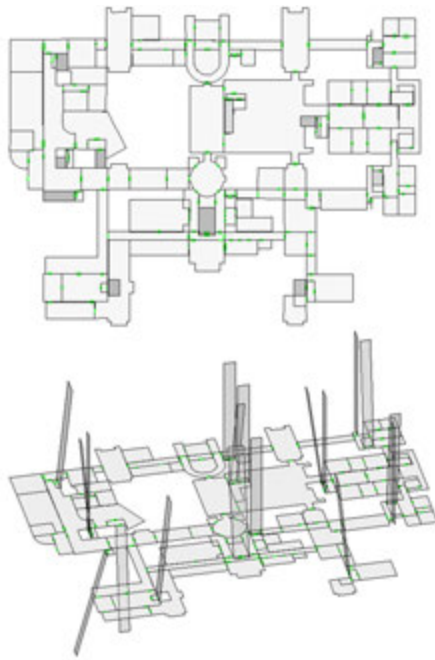

(a)

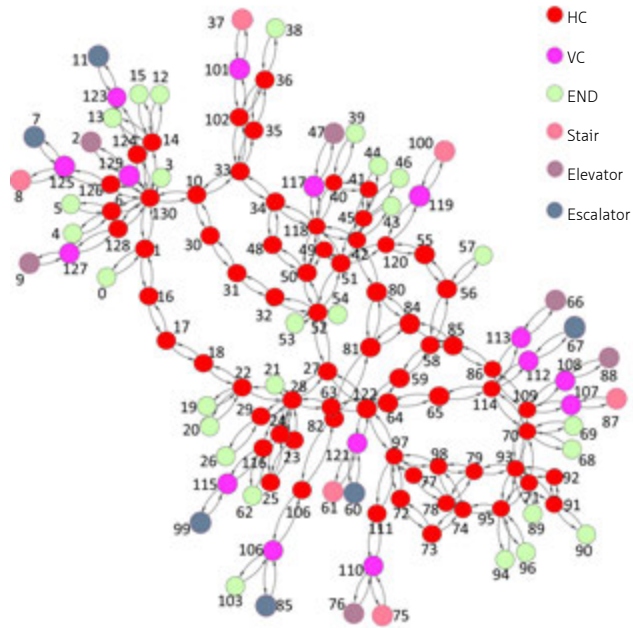

(b)

FIGURE 6.11 The logical network of *MFA*. (a) The INSM shown in an aerial view and in a rotated view. 3D polygons in the vertical direction are *VUs*; and (b) The logical network.

Similarly, the logical network of *MFA* is obtained (see Figure 6.11a). In this logical network, some *VU* nodes seem like *End* nodes (see Figure 6.11b) because the other related floors are not presented. As mentioned before, *MFA* is a *complex* building, thus multiple logical paths may exist between two spaces.

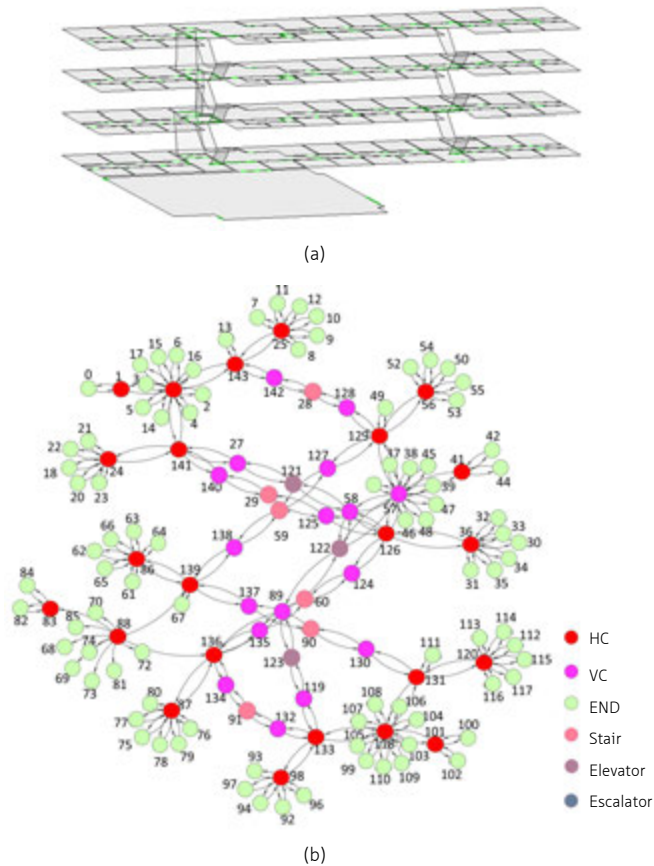

FIGURE 6.12 The logical network of *OTB*. (a) The INSM; and (b) The logical network.

The logical networks of *OTB* and *Schiphol Airport* are given in Figure 6.12 and Figure 6.13. The one of *Schiphol Airport* is used to test the *Floor* strategy. The other two criteria applicable to single floors are tested in *MFA*: the *minimum NU* and *central HC* are applied in a priority order. On both logical networks, the routing option L1.1 (see Chapter 3) is implemented. Details of the tested routing criteria are below:

- *Floor strategy*. The Floor strategy helps a user to arrive first at the floor of a destination. This means *VUs* near the user are located first.
- *Minimum NU*. The Minimum NU criterion aims at a logical path through the fewest number of spaces.

- *Central HC*. The Central HC criterion collects the high accumulated centrality of HCs in a logical path without detours to the target, which ensures the horizontal motion is on the central sections (e.g., main corridors) of each floor.

The *Floor strategy* is realized because *Schiphol Airport* (see Figure 6.13) is a multi-floor complex building where multiple paths can exist between two spaces on different floors. Suppose that a traveller needs to find her/his path from the entrance hall to the correct check-in point. The traveller has the following profile: [*Adult, With-Wheeled-Devices, Visitor, 0.6m*]. This is a typical profile for travellers since most of them bring some luggage on trolleys to their destinations. In this example, a size of a traveller with luggage is set to 0.6 meter(m) which is only used for geometric routing. *Escalator* is specified in the *Floor strategy* for the traveller, because it saves the traveller effort to bring the luggage to the target location. There are two resulting logical paths through *Escalators* (Figure 6.14).

Another routing test is presented on *MFA* (Figure 6.15). This is a case that routing is conducted with multiple criteria on the logical network. In the logical network of *MFA* (Figure 6.11), a visitor is assumed to have the following profile: [*Adult, Walking, Visitor, 0.5m*]. A priority order is set for two criteria for routing: 1) *minimum NU*, and 2) *central HC*. This order means firstly the visitor needs to walk to the target room by crossing the fewest number of spaces (*minimum NU*), and secondly she/he aims to pass through the central section of *MFA* (*central HC*). In this example the visitor does not change floors. After applying the criterion *Minimum NU* to the logical network, two logical paths are computed (Figure 6.15a). A unique path (see Figure 6.15b) is obtained after applying the criterion *Central HC* to the previous two logical paths. This unique path has higher node centrality and it is relatively easy to change the path at each node.

As can be observed from the images (Figure 6.14 and Figure 6.15), the above logical paths are visualized as a sequence of spaces, which helps a user to identify the path that she/he needs. In both the complex buildings of *Schiphol Airport* and *MFA*, multiple logical paths exist between the given start and target spaces. In such a case, it is necessary to select the proper logical path according to a user profile when the user requests a definite path. Using the priority order of multiple criteria is an efficient method to select logical paths.

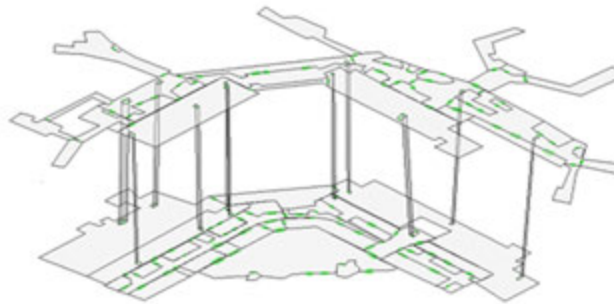

(a)

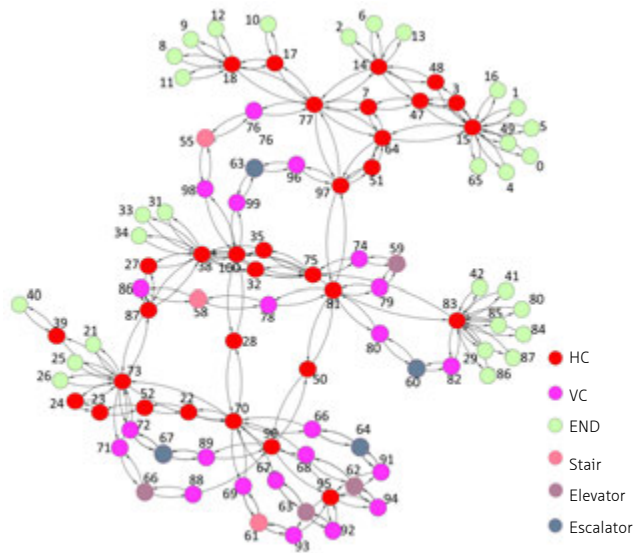

(b)

FIGURE 6.13 The logical network of *Schiphol Airport*. (a) The INSM; and (b) The logical network.

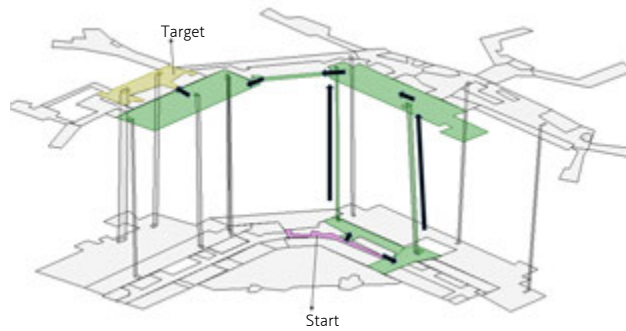

FIGURE 6.14 Paths complying with the *Floor* strategy. Two logical paths are derived. The black arrows show the directions of the logical paths.

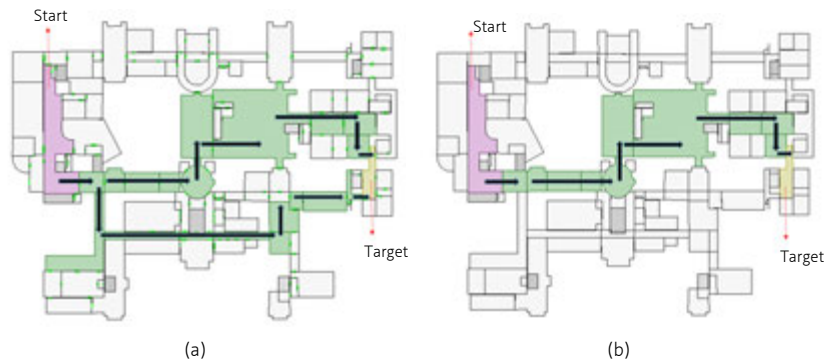

FIGURE 6.15 Routing with two criteria on the logical network of MFA. (a). Two *minimum NU* paths; and (b) The *minimum NU + central HC* path.

§ 6.3.2 Geometric network

This section presents routing on geometric networks in a single space and a sequence of spaces. Such a routing depends on the size of users. Chapter 5 mentioned that the complete geometric network of a building can be formed with geometric networks in each single space, without details of the procedure. This section presents the implementation of geometric network generation, which is influenced by obstacles and user size. As mentioned before, *INSMs* contain obstacle information and the designed user profile includes the parameter of user size.

The following tests are conducted:

1. In a space, routing with different sizes between the same start and target doors, to check geometric paths from the different results of obstacle grouping. For example, a visitor and a maintenance worker go to the same target location. Because the maintenance worker brings an indoor investigation device, her/his size is larger than the visitor. The routing regarding each size is related to routing option G2.1 (see Chapter 3) that needs no POIs but a user size.
2. In a space, routing when the same user moves in a space changing different sizes. For example, a person needs to pick up a luggage trolley at a specific location in a space, and then pushes it to the next location. This test is the implementation of routing option G2.3 (see Chapter 3) where POIs with different user sizes are specified.
3. Given a sequence of spaces, to form geometric networks in each space into a larger geometric network including doors and POIs. For example, a person assigns a logical path indicated by a number of spaces, and then she/he requests an accessible geometric path passing through some POIs. Thus a geometric network is created first regarding these spaces. This test is related to routing option G2.2 (see Chapter 3) that provides multiple POIs and their ordering.

The first test is to demonstrate the influence of obstacles and user size on geometric paths. In the second test, routing with two different sizes of one user is applied in one space. The third test demonstrates how a geometric path can be computed for more than one space. As mentioned in Chapter 3, all the locations represented by geometric nodes are doors and *POIs*. The third test also includes some windows, and they are specified as *POIs* since normally they are not used for transfer among spaces.

Geometric paths are computed based on two *INSMs* of *CNICU* (see Figure 6.16a) and *BK* (see Figure 6.16b). The *CNICU* contains many indoor obstacles, but the *BK* contains few indoor obstacles.

In the *INSM* of *CNICU*, the test is conducted for users with respect to three sizes: 0.5 m, 0.6 m and 0.8 m. The first size represents a common width of a person (Figure 6.17a). The second size 0.6m can be considered for a person who is pushing a wheelchair (Figure 6.17b), e.g., a care worker. The third size 0.8 m is used for a maintenance worker (Figure 6.17c), for example, one who needs to bring equipment to repair electrical wiring in the ceiling.

The test clearly shows the effect of user sizes on the computed paths. In the test it is assumed that users keep a distance from the walls. Therefore, a buffer of 0.5/0.6/0.8m

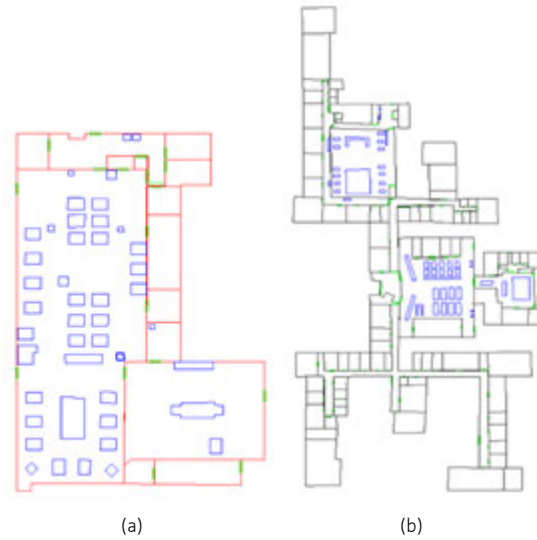

FIGURE 6.16 The INSM of two buildings. (a) CNICU; and (b) BK.

is created around the walls (the dashed polygons in Figure 6.18). In Figure 6.18a, the shortest path for 0.5 m lies in the middle of the *Final Convex Hull* (FCH, the black polygon) between two doors. Figure 6.18b presents the path for 0.6 m where a part of the path is on the edge of FCH. There is no path for 0.8 m users (see Figure 6.18c).

A user can be informed in advance about the accessible geometric path for a given size, or no available paths. As visible in Figure 6.18, there is a small difference (0.3 m) between the user sizes in figures 6.18a and 6.18c, but there is no path in Figure 6.18c.

In the *INSM* of BK, routing for a person with changing sizes in selected spaces is presented. Given a student with the size 0.5 m, she/he walks into the designing hall to get a trolley to move a number of architectural models, and then crosses the space to arrive at the next one (Figure 6.19). The start location is an entrance door on the left of the hall (Figure 6.20a), and the target location is the door on the right of this hall (Figure 6.20b). The size of the student increases to 1.2m after she/he arrives at the trolley place. After the student walks into the next space, the user size does not change. To realize this case, a POI is added at the location of the trolley (the black point in Figure 6.20a). A path is computed first for the original size 0.5m by grouping related obstacles. Then another path is computed for the changed size 1.2m from the POI to the target location. The two geometric paths are combined as one for both the sizes before and after the change (Figure 6.20c). A geometric network (Figure 6.20d) in the next space for the size 1.2m is also generated.

As described in Chapter 5, the set of all the shortest paths for a given size compose the geometric network. Normally one geometric network in a space is computed for a given user size. This network can be either created 'on the fly' or pre-computed. However, in the case in Figure 6.20c, it is not wise to pre-compute several geometric networks

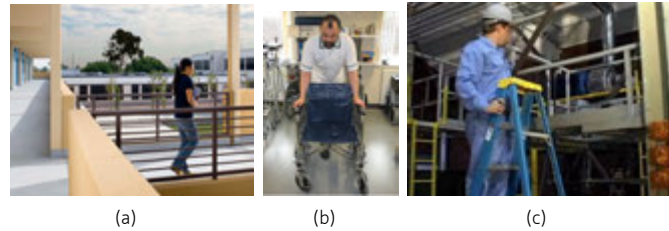

FIGURE 6.17 Different users. (a) Common pedestrian (from www.prefast.com); (b) Care worker (from www.friendsofsavernake.org); and (c) Maintenance worker (from www.americantrainingresources.com/ptv-127.aspx).

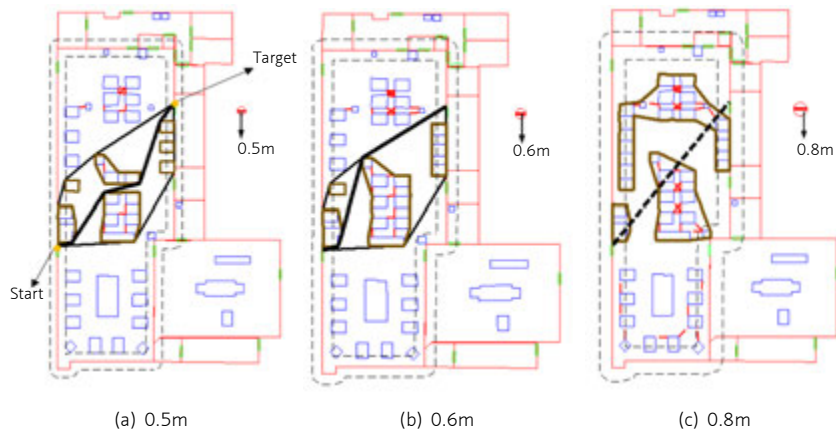

FIGURE 6.18 Routing for the sizes of 0.5 m, 0.6 m and 0.8 m. (a) The shortest path for 0.5 m; (b) The shortest path for 0.6 m; and (c) No path for 0.8 m. The dashed polygons represent the buffer to the walls.

in the space and store them. Thus paths are computed on the geometric network derived 'on the fly', based on the start and target doors and the POI where the user size changes.

The following test will demonstrate how to link geometric networks in single spaces and aggregate them into a larger geometric network. Four spaces are selected to construct geometric networks sequentially. All the creation of geometric networks in these spaces is for a user size of 0.5 m. Firstly the shortest paths for 0.5m among the doors and POIs are computed in each space, and then the geometric network consists of all these shortest paths. Door-to-door paths are used for transfer among spaces since the inside of spaces is not interesting to a user. But a door-to-POI or a POI-to-door path is contained inside a space and refers to a location to be visited, such as the reception desk, the platform, or the window in Figure 6.21b. When the geometric networks in the four spaces are combined into one (Figure 6.21b), a geometric path through three ordered POIs is computed (Figure 6.21c).



FIGURE 6.19 The designing hall in *BK* (from tudelft-architecture.nl). It is a space with a group of obstacles where routing is conducted for a user with changing sizes.

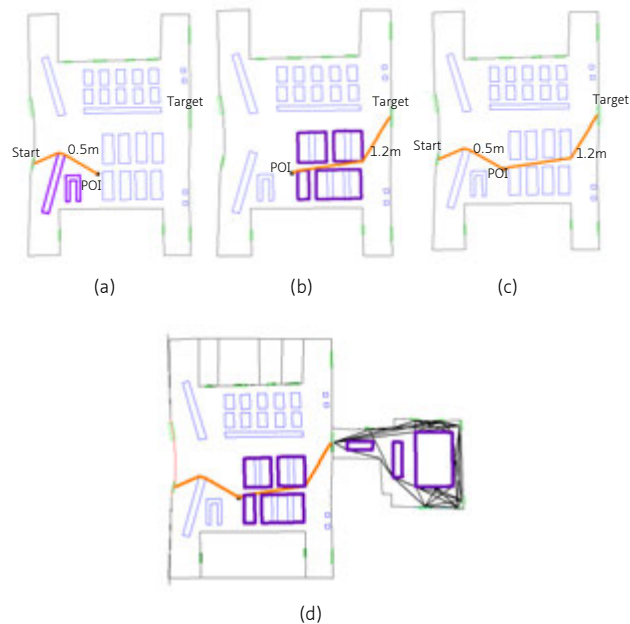

FIGURE 6.20 Change of user size in one space. (a) Path for the 0.5 m size from the start door to a POI. The highlighted polygons represent the grouping results of obstacles; (b) Path for the 1.2 m size from the POI to the target door; (c) The final path for the user between the two doors; (d) A geometric network for 1.2m in the next space.

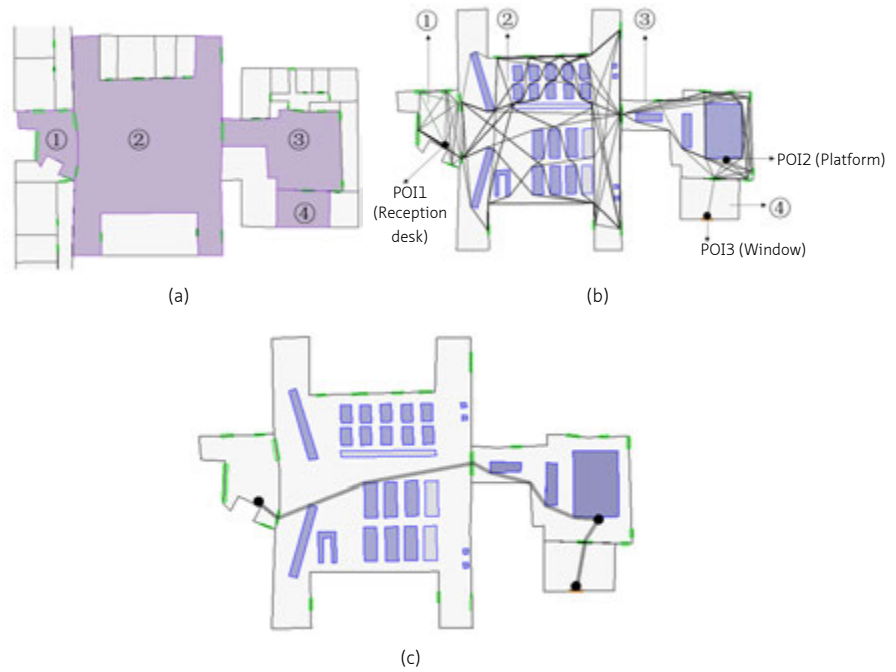

FIGURE 6.21 Geometric network for four spaces in *BK* for the size 0.5m. (a) A logical path (highlighted spaces). Space 1 is the start, and space 4 is the target; (b) Complete geometric network for the four spaces, regarding doors and POIs; and (c) A geometric path from the POI in space 1 to the POI in space 4.

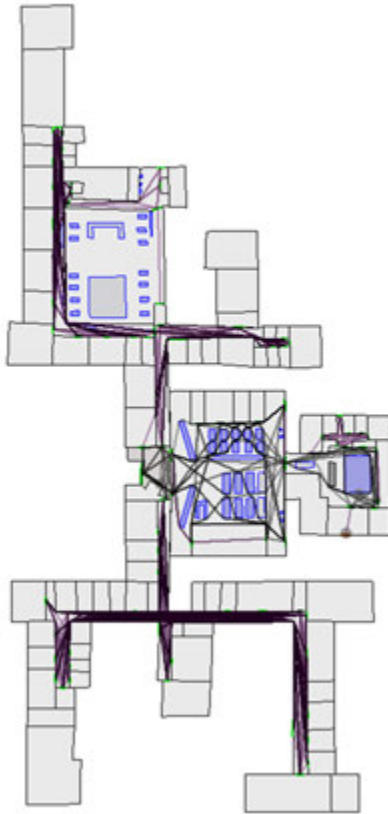

FIGURE 6.22 The complete geometric network of *BK* for the size 0.5m. This network considers only door-to-door paths and it contains 2216 geometric edges.

Similarly, if a complete geometric network of the whole floor is needed for a user with a given size (e.g., 0.5 m), the complete geometric network can be constructed by putting together all the geometric networks in all these spaces (Figure 6.22).

§ 6.4 Analysis of the tests

This section elaborates on the results presented in sections 6.2 and 6.3, discusses the used classes of *INSM* and suggests future implementation of one-level routing.

As mentioned in Section 6.2.1, the main classes of *INSM* (*HU*, *VU*, *Opening*, *Obstacle* and *PointOfInterest*) are implemented as *MicroStation V8i* layers. To generate the logical network, *NU* and *OPN* are mostly used. In particular, *VC*, *HC*, and *End*, the subclasses of *HU*, are automatically determined by a procedure (see Figure 6.3). Other bottom-level subclasses of the above classes, such as *Stair*, *Elevator*, *Escalator*, *Door*, *FacadeWindow* and *InteriorWindow*, are attached to instances in related layers as attributes in *MicroStation V8i*. The aggregation classes (*HS*, *VS*, *NBS*, *BP* and *BLD*) are omitted for the generation of logical networks.

Though not all *INSM* classes are necessarily used for the generation of logical networks, the aggregation classes should be adopted when a hierarchical structure of a building needs to be created for other applications. These classes are designed to increase the abundance of semantics of *INSM*. For instance, when a logical network for floors is required, *HorizontalSpace* (*HS*) instances representing floors and *VerticalSpace* (*VS*) instances linking the floors would be used to generate this logical network (see Figure 3.5 in Chapter 3). According to a functional subdivision, some conceptual regions (without physical boundaries) of a building can be depicted as well. In such cases, *HS* and/or *VS* can also represent the collection of these regions. Thus *HS* and *VS* can be applied to distinguish between different granularities. *NavigableBuildingSpace*, the superclass of *HS* and *VS*, is useful for inquiries about the free space in a whole building. The class *BuildingPart* can depict some special cases of buildings, such as several building parts connected by sky bridges. In general, these aggregation classes can be applied to different granularities for a hierarchical model of the building. But in this thesis, the focus is only on two granularities, i.e., independent spaces physically bounded by walls and the details in the spaces.

For the generation of geometric networks, three main *INSM* classes – *NU*, *OPN* and *OBS* (one of the subclasses of *NonNU*) are adopted. *Wall*, another subclass of *NonNU*, would not influence the created geometric networks since its instances are not accessible. Although they are digitalized (see Figure 6.2b), they are used only to support the creation of *HUs*. As a *Wall* is separate from navigable spaces, the two-level routing would not be impacted by the absence of it. In the *INSM* model *Window* and *Door* are subclasses of *OPN*. *Door* is mostly used in the previous tests, while *Windows* are also applicable as POI. Whenever a user plans to consider windows for indoor routing (e.g., in emergency cases), they could be added in a geometric network. Figure 6.21 presents an example of a window as a POI. In general, both *Door* and *Window* can be specified as POIs.

For the creation of geometric networks, the aggregation classes (e.g., *VerticalSpace*(*VS*), *HorizontalSpace*(*HS*), *NavigableBuildingSpace*(*NBS*) and *BuildingPart*(*BP*), see figures

3.5 & 3.6) in the conceptual data model of *INSM* are also not used. In a word, all these classes enhance the representational ability of *INSM* with cases of composition spaces, but in the tests they are not used for the generation of logical and geometric networks. Only a part of *INSM* is used to conduct the routing. These aggregation classes can be useful for some other applications (e.g., needing a detailed hierarchy of spaces).

In a building, different users can reach distinct parts of the building in the form of *INSM*. Even for public buildings, it is not recommended to expose all the building information to all. In this case, *INSM* can be used to decide which parts of a building are to be exposed and to what type of user. For instance, the image of *Schiphol Airport* contains only a part of the airport information for the public. With regard to data safety, a user can access building information in light of her/his permission level. A part of a building model needs to be selected for a specific user according to the user's profile. For example, a visitor cannot access electricity wells for maintenance. Thus all the spaces for technicians are not open to the visitor. Paths for the visitor are computed on the basis of a subset of the overall *INSM*. In contrast, an administrator gains the complete view on the *INSM* since she/he has the highest access permission in the building.

The test results of logical networks (see Section 6.3.1) indicate there can be multiple logical paths between two spaces, even after applying a priority order of criteria. At present, all the related logical paths for a user are computed. To handle multiple paths, three methods can be applied: 1) to provide all the logical paths to a user; 2) to ask a user to select one of them; 3) to compute first all their corresponding geometric paths, and then select the logical path regarding the 'best' geometric path (e.g., it can be the 'shortest' one among them).

The main advantage of using logical networks is that spaces are represented conceptually. For instance, a coffee corner is an open space without a physical boundary, but it can be considered an SOI and be represented in a logical network. Humans can understand the logical path as verbal or textual descriptions, such as 'the current space is the *entrance hall*, the next space is the *long corridor*, and then the *left stair...*'.

Logical networks are derived from *INSM* according to connectivity relationships among spaces. Edges of logical networks represent the connectivity of spaces regardless of one or multiple doors. For instance, two spaces are connected via three doors (Figure 6.23a) and in the logical network the three doors are represented by two directed edges (see Figure 6.23b). Although in a logical path a user can understand which spaces would be visited, the door to pass is not specified. This can be done in the two-level routing approach, where a user is given the exact door to use.

To consider multiple doors connecting two spaces in a logical path, multiple edges should be allowed to connect the two spaces (Figure 6.23). Such a network is called *multigraph* [Die10]. However, such networks still do not help to mediate a specific door. It simply provides the information that more options are possible. Therefore, the logical network used in this research does not allow multiple edges between two spaces.

The tests in Section 6.3.2 show that a geometric path between two doors of a space is influenced by the distance among obstacles and those between obstacles and physical boundaries of space. For a user whose size changes while moving in a space, the creation of a complete geometric network in advance is not recommended, because the

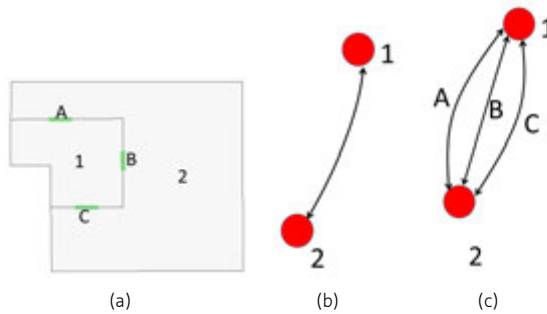

FIGURE 6.23 Multiple connectivity between two spaces linked with three doors. (a) Two spaces and three doors; (b) Logical edges of the spaces representing the connectivity; and (c) A network where the edges represent multiple directed connections between the spaces.

network heavily depends on the motion (the start location, intermediate POIs and the target location) and the user sizes. The test result (Figure 6.21c) suggests that a good option would be to compute a geometric path only 'on the fly' in the space. In this case it is unnecessary to maintain two different networks for the two user sizes in the same space.

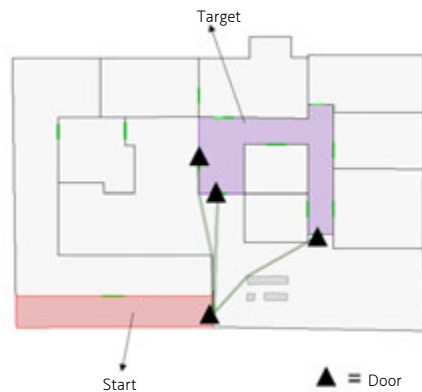

FIGURE 6.24 Door selection for a geometric path based on a logical path. The black lines are three geometric paths to the target space via different doors. The middle path refers to the closest door to the start location.

In this implementation, routing on geometric networks is conducted without consideration of user profiles (except user size). As given in Chapter 5, geometric paths are computed with the *Dijkstra* algorithm, *i.e.*, the shortest path in a geometric network. Doors in between multiple spaces are determined by the shortest path. However, geometric paths can also be computed in each space and be formed into a whole path, when the routing takes into account a user's needs on doors and turns. Figure 6.24 is an example of a user that is given the option to select a geometric path in a space. The red space is the start space and the blue one is the target space. There are three geo-

metric paths inside the current space. The user selects the middle path (Figure 6.24) since it leads to the closest door. In this way, given a logical path, paths in each space can be determined by a certain criterion (e.g., the closest door) and then be aggregated into a complete geometric path.

§ 6.5 Summary

Section 6.1 presents the used software tools, data and user profile format for implementing one-level routing. Section 6.2 presents the creation of *INSM* based on the adopted real building data. A general procedure of *INSM* generation is elaborated and illustrated with floor plans, *IFC* and *CityGML LoD4* models. This procedure requires manual effort. Section 6.3 presents the results of logical and geometric routing with designed scenarios of real buildings. Section 6.4 discusses the use of *INSM* based on these routing results and elaborates on further cases about both logical and geometric routing.

This chapter partially answers the following research sub-question:

6. How are the new proposed user-related paths implemented and applied to realistic cases?

Section 6.3.1 presents the implementation of three proposed routing criteria as typical examples (*Floor strategy*, *Minimum NU* and *Central HC*). The user-related information is reflected in the designed user profile (see Section 6.1.2) including parameters of *age*, *mobility*, *role*, and *size*. Combinations of these parameters for a user can be linked to specific path preferences in the logical network. In the implementation an association is assumed between a user profile and her/his preference of logical paths.

Section 6.3.2 illustrates the implementation of geometric routing in three realistic scenarios: 1) separate users with distinct sizes; 2) one user with changing sizes; and 3) formation of a geometric network from a sequence of spaces. Tests show that the size of a user critically influences the shape of a geometric path. In the proposed routing method (see Chapter 5), both the cases of distinct user sizes and one user with changing sizes are tested. According to the interaction of a user, an aggregated geometric network can be formed from any selected spaces, which shows the flexibility of generating user-related geometric networks. This flexibility stimulates a user to give more consideration to the abstract level (about spaces), and obtain customized logical and geometric paths.

For the same research sub-question, the next chapter will introduce the implementation of the two-level routing, which integrates both the logical and geometric routing for different users.

7 Realization of two-level routing

In this chapter, three factors are considered for the implementation of two-level routing: 1) the way to compute the data content for three models (*INSM*, and two derived models – the logical network and the geometric network); 2) the place to store the three models (*i.e.*, data organization); and 3) user interaction. In Section 7.1 five cases are presented with client-server architecture that can be implemented for desktop and mobile platforms: one of them is for desktop applications and the others for mobile applications. Two of the implemented cases are elaborated, *i.e.*, the desktop application (Section 7.2) and a mobile application (Section 7.3). To cater for different user sizes, the desktop application derives geometric networks on the fly, and two-level routing is conducted with three typical routing options (C3.1, C3.3 and C3.6) that were introduced in Chapter 3. Option C3.1 is routing regarding a constant user size without SpaceOfInterest (SOI)/PointOfInterest (POI); Option C3.3 refers to changing sizes with ordered POIs; Option C3.6 is about a constant user size with ordered SOIs/POIs. Routing results for two different buildings are compared and analysed in performance and the involved number of points used for geometric networks.

A two-level routing mock-up is implemented with *Bentley Systems Mobile SDK* in a Bentley mobile application *Navigator Mobile*. With a lightweight dataset of logical and geometric networks, the two-level routing function has been developed in the simulator of the *Navigator Mobile*. The exchangeable data format *i-model* [Sys16c] of Bentley Systems is used for this mock-up. The conceptual models of the logical and geometric network (see Chapter 3) are implemented as XML-based data schemas for the mock-up. The logical and geometric networks of the building are derived first in the desktop application, and they are stored in *ECSchema* files (a XML-based file of Bentley Systems) [Sol16]. Finally, the *INSM*, the *ECSchema* files and the 3D building model are wrapped into an *i-model* dataset. Section 7.3 will present routing on the logical and geometric networks in the mobile application. The two-level routing mock-up demonstrates the feasibility of the two-level routing on a mobile device. This mobile mock-up stores one complete geometric network for users with a given size. The testing results show the two-level routing can be independently conducted in this mobile mock-up. Section 7.4 discusses the test results and provides the future improvement on the two-level routing approach. This chapter is closed with a summary in Section 7.5. This chapter is based on three author's own publications: [LZ11a, LZ13b, LZ13a].

§ 7.1 Factors considered for realization

Model creation. For the implementation, the first factor to be considered is how the data content for *INSM* and two sub models (the logical network and the geometric network) can be created. The *INSM* is too complex to be obtained automatically, thus it is worthwhile being created once and stored. The logical network of all the spaces in a building can be created once and maintained, because in normal conditions these spaces do not change. For certain cases, a part of these spaces needs to be selected to form a specific logical network for a user (*e.g.*, a visitor with a wheelchair). Access permission and accessibility for different users are stored as an attribute of the edges. In

this case, a sub-logical network can be selected 'on the fly'. Therefore, a logical network for users can be either pre-computed or derived 'on the fly'.

Similarly, for a given user the complete geometric network can be maintained for a building. According to the building owners, they may only need several geometric networks for different user sizes in common situations. They also need to adopt new user profiles to derive suitable geometric networks 'on the fly'. In addition, when a logical path is re-computed in the light of a changed user size, only the related spaces contribute to the creation of the corresponding geometric network. In this case, the geometric network is computed 'on the fly' as well. Thus the geometric network can be either pre-computed (for one or more sizes) or derived 'on the fly' (for different sizes).

Model storage. The second factor is where the three models can be stored. The Client-Server architecture provides different possibilities to deploy the three models for two-level routing. Specifically, INSM and the logical and the geometric networks can be flexibly computed and stored in different hosts. The generated data are stored in *DGN* (*desktop*) files and *i-model* (*mobile*) files of Bentley's format functionally similar to a Database Management System (DBMS) [Sys16c].

For example, one can store the INSM in a user's mobile device for visualization, develop an application in a server to compute paths on the logical and geometric networks for the user, and send the paths back to the mobile device. For a building, a complete geometric network is always larger than a logical network, and the INSM of a building can be larger than the geometric network. An alternative is to store all these models in a server, and the mobile device can then download and visualize the necessary parts of the INSM and computed paths.

Generally, a thin client is considered only for the visualization of paths in the building, without keeping all three models (INSM, and the logical & the geometric networks) and path computation. The data for visualization is downloaded from the server side. A thick client is dependent on its functionality: it should be able to locally compute the two-level routing results customized for a user's profile. In order to process the routing tasks, a thick client requires higher processing ability than a thin client. The routing computation on the thick client includes the creation of logical and/or geometric networks and path computation on these networks. For a mobile application, in addition to routing computation the data amount should also be considered for a client, because considerable storage may increase the load for mobile devices (e.g., the INSM of a group of buildings in a campus). Along with the increasing computational ability of mobile devices, the thick client would be more affordable and users can benefit from routing on mobile devices in the offline phase.

Five cases are presented for implementation of two-level routing with the Client-Server structure (see Table 7.1). The first two cases have been implemented in this thesis. They are both thick clients, *i.e.*, both the logical and geometric routing is conducted on the client. The main difference of the two cases is if they are desktop (Case 1) or mobile (Case 2) clients for implementation (see Table 7.1). The other three cases are thin clients, which means the client only stores lightweight data (INSM and/or a logical network) or no data, and receives computed geometric paths from the server. In the third case, the server owns the complete geometric network while the client maintains only the logical network and the INSM. The fourth case adds the INSM, and the logical and the geometric networks on the server, and thus the client does not conduct any compu-

TABLE 7.1 Five cases of the implementation of two-level routing in a Client-Server structure. '+' is stored and '-' is not stored or derived on demands.

Case		INSM data	Logical network	Geometric network	Type	Application	Implemented in this thesis?
1	Client	+	+	-	Thick client	Desktop	Yes
	server	-	-	-			
2	Client	+	+	+	Thick client	Mobile	Yes
	server	-	-	-			
3	Client	+	+	-	Thin client	Mobile	No
	server	+	+	+			
4	Client	-	-	-	Thin client	Mobile	No
	server	+	+	+			
5	Client	-	-	-	Thin client	Mobile	No
	server	+	+	-			

tation but only visualize paths received from the server. The fifth case is similar to the fourth one, but the server stores no pre-computed geometric network. In this case, all the geometric paths are computed 'on the fly'.

Table 7.1 indicates the places to store the three models and the creation of geometric networks. Case 1 represents a thick client: the INSM and the logical network are stored in the client. The client computes geometric networks 'on the fly'. This case is suitable for a desktop application since the desktop is capable of deriving geometric networks in real time for the two-level routing. For example, routing services are requested by an airport administrator who needs to check suitable paths for different people. Logical paths and geometric paths are all computed in the desktop client. It provides indoor routing and only serves a local user. Then Case 1 can present the requested path on the desktop computer.

Case 2 is similar to Case 1 but it pre-computes and stores geometric networks for certain user sizes in the client. Case 2 is implemented as a thick client. This case can be applied to mobile device. Suppose that the facility manager of an airport wants to find her/his way using a tablet. As all three models are stored on the mobile device, the two-level routing can be conducted in the offline phase (without the internet), which is quite convenient for specific users (e.g., an employee in a factory without a WiFi connection). Thus the application in the tablet provides indoor two-level routing for the user. Case 1 and Case 2 are implemented and will be introduced in Section 7.2 and 7.3, respectively.

In Case 3 the client only stores the INSM and the logical network, while geometric networks (for different user sizes) are pre-computed and stored on the server side (See Figure 7.1a). This case is a thin client since the two-level routing is conducted on the server, which can be a mobile application. For example, the mobile application sup-

ports visualization of the logical network, and a user is familiar with the indoor environment and she/he wants to specify logical paths on demand. The user-specified logical paths can be sent to the server to generate geometric paths, then the geometric paths are sent back to the user on the client. In the mobile client an interface should be developed for a user to input preferences on routing (e.g., to select routing criteria and their priority order, to select SOIs and POIs in the building model or input space ID and/or POI coordinates). Also, the start and target locations are specified by the user via this interface. The selected routing criteria of logical paths are sent to the server, and then the server will compute the logical path and the corresponding geometric path and return this result to the user.

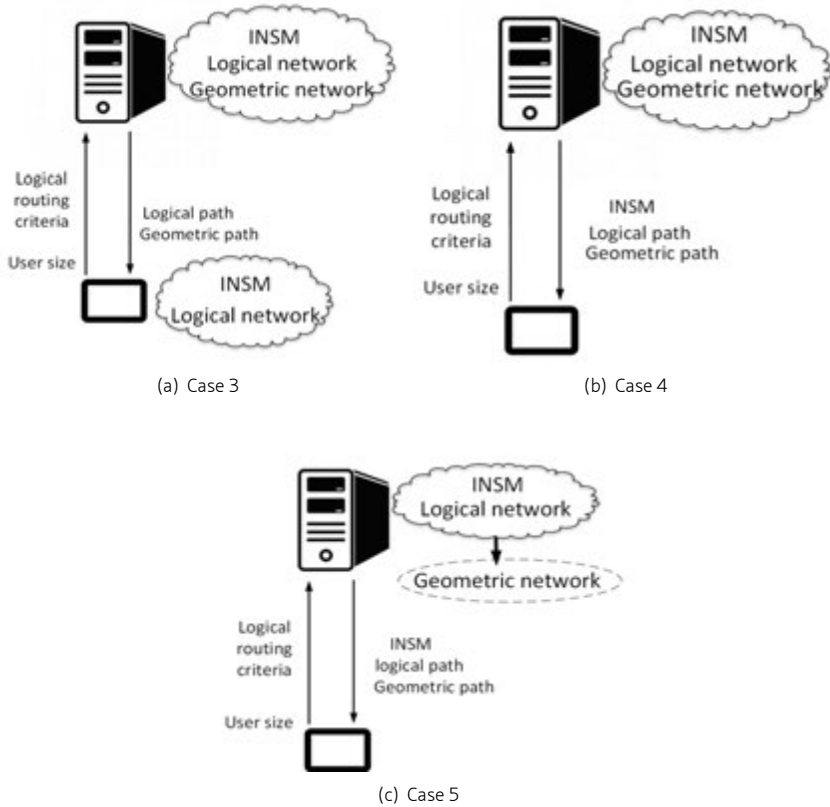

FIGURE 7.1 Client-Server architectures for routing performed on the server. (a) Case 3. All 3 models are pre-defined on the server; INSM and logical network on the client, but geometric paths downloaded 'on the fly'; (b) Case 4. All the 3 models pre-defined on the server, but no models on the client. INSM and paths downloaded in the client 'on the fly'; and (c) Case 5. INSM and logical network pre-defined on the server, but geometric networks derived 'on the fly'; INSM and paths downloaded in the client 'on the fly'.

In Case 4 the client stores none of the three models (Figure 7.1b). INSM, the logical network and pre-computed geometric networks are stored on the server side. As a thin client, Case 4 is suitable for a mobile application. In such a case, in the mobile client a

user needs the interface to specify the start/target by pre-defined textual references (e.g., names) and routing preferences, and to download and visualize the final paths and necessary parts of the INSM (e.g., some spaces).

In Case 5 the client does not store any data, while the server derives the geometric network in real time on demand (Figure 7.1c). This case is an example of a thin client, which also can be adopted for a mobile application. Cases 3, 4 and 5 are not implemented in this thesis.

User interaction. The user can interact with a routing application to adjust a path. A user needs to specify the start and target spaces and/or locations. In all the cases in Table 7.1, the user needs to input the user profile, or specify routing criteria for logical paths and the user size for geometric paths. As mentioned in Section 3.4.3, a user can also specify SOIs and POIs, and the sequence of the SOIs/POIs to be visited. Additionally, a user can supply different sizes for herself/himself changing at specific locations (POIs). After all the information is provided, a complete accessible path(s) is computed for these given sizes via these POIs.

In the application, a user can decide whether routing can be solved only with a logical network. The two-level routing is not necessarily applied to every routing request. For instance, a geometric path is not needed when the user considers a logical path is simple and she/he can follow it either because the user is familiar with the building or because she/he prefers general path descriptions. But a user can also manually select a logical path and request the related geometric path. Such a situation can be realized by a Client-Server application as in Case 3: the user selects a logical path in the mobile client and sends the logical path to the server, then a geometric path is computed by the server and sent back to the client.

§ 7.2 Desktop application

To address Case 1 in Table 7.1, this section introduces two-level routing implemented on a desktop computer. The *Thick client* application is implemented in a desktop computer which manages all three parts (the INSM, and the logical and the geometric networks). In this application, the server can be skipped since the computation is conducted locally.

An application is developed in the *MicroStation V8i*. It collects spaces of INSM, detects connectivity of the spaces, creates and stores logical network, and creates geometric networks on the fly. Specifically, INSM is stored as a *DGN* file which contains the semantics and geometry of a building. The derived logical network is stored in this *DGN* file as well. Geometric networks are created 'on the fly' during the routing computation. In this implementation, all the logical paths are visualized by a sequence of highlighted spaces in the INSM.

To evaluate the performance of the two-level routing approach in a complex and a simple building, three typical options for indoor navigation are selected and implemented in the old OTB building (OTB for short) and Schiphol Airport, i.e., options C3.1, C3.3 and C3.6 (see Table 7.2).

1. Option C3.1 refers to a case where the user does not provide preferences. It requires no SOI or POI, thus a user without an obvious preference would select the option to automatically obtain logical and geometric paths. This option is implemented in the two buildings to compare the number of logical paths.
2. Option C3.6 refers to the interaction of users with the routing application. This option allows the user to specify SOIs and/or POIs. This option demonstrates the forms of logical and geometric paths in the two buildings, and analyzes their differences.
3. Option C3.3 refers to cases that involve changes of a user size. Such a path is a combination of two geometric paths: 1) the first part from the start to a specified POI with size 1; and 2) the second part from the POI to the target with a new size 2. Practically the same type of computation is conducted twice for the two parts before and after the POI, but with different sizes. Option C3.3 is implemented in the two buildings and used to compare the time costs and involved nodes of the routing results.

User profiles are used in these implementations (see Chapter 6). Four parameters are maintained to reflect the user profile (*i.e.*, *age*, *mobility*, *role* and *size*). They are linked to related criteria for routing in the logical network. Table 7.2 lists the implemented routing options, user profiles and related routing criteria in the logical network.

TABLE 7.2 The tested routing options for *Schiphol Airport* and *OTB*.

INSM	Tested option	User profile	Logical path criteria
OTB	Option C3.1	[Adult, Walking, Visitor, 0.5m]	Floor strategy
	Option C3.3	[Adult, With-Wheeled-device, Maintenance Worker, (0.8m, 0.5m)]	SOI strategy
	Option C3.6	[Adult, Walking, Visitor, 0.5m]	SOI strategy
Schiphol	Option C3.1	[Adult, Effort-Saving-Motion, Visitor, 0.5m]	Floor strategy + Central HC
	Option C3.3	[Adult, With-Wheeled-Devices, Administrator, (0.5m, 1.2m)]	SOI strategy
	Option C3.6	[Adult, Walking, Visitor, 0.6m]	SOI strategy

In the implemented applications, distinct colours are used for the start and target spaces, logical paths and SOIs as in Chapter 3. Specifically, the *Start* spaces are in light purple; the *Target* spaces are in light yellow; the SOI is presented in cyan pink; the logical paths are shown with green spaces; and the POIs are depicted by black dots.

§ 7.2.1 Routing without SOIs and with one size

In the OTB building, option C3.1 and C3.6 are implemented for a visitor. The user profile is [Adult, Walking, Visitor, 0.5m] (see Table 7.2). The scenario for option C3.1 is that the user at an employee's office on the third floor intends to find the main entrance. In this case, the *Floor* strategy is applied to compute the logical and geometric paths for the user automatically.

The number of logical paths is compared for *OTB* and *Schiphol Airport*. The logical paths of the *Floor* strategy in *OTB* starts from a space on the third floor and lead to a space

on the first floor. This logical path crosses the stair close to the start space (see Figure 7.2a). As it is only one path, a geometric path is computed based on this logical path (see Figure 7.2b).

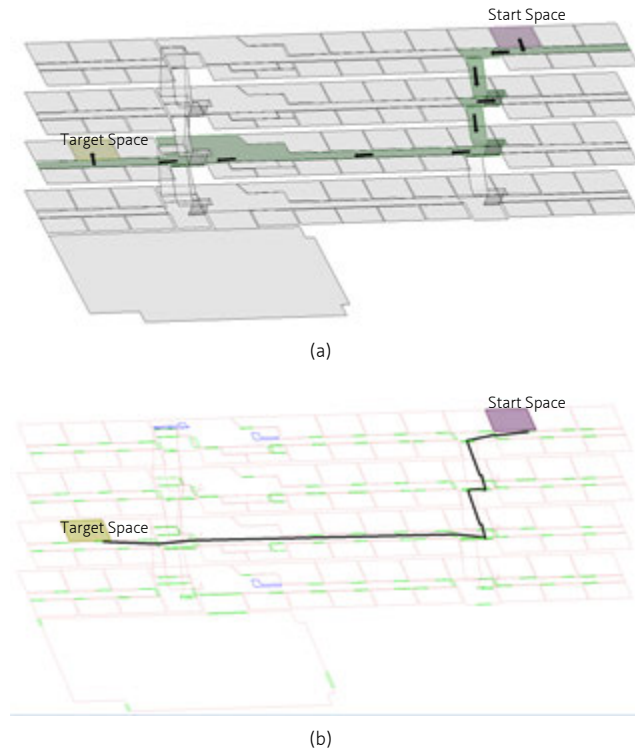
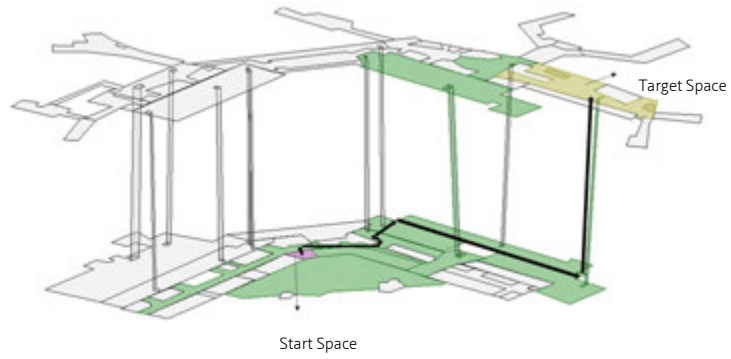

FIGURE 7.2 Implementation of routing option C3.1 in the old OTB building. (a) The logical path of the Floor strategy; and (b) The geometric path related to the Floor strategy.

Option C3.1 on *Schiphol Airport* illustrates the different results. In the scenario is a traveller with luggage who needs escalators and heads to a fixed check-in point. The user profile is [Adult, Effort-Saving-Motion, Visitor, 0.5m].

In *Schiphol Airport* a priority order is applied: the first one is the *Floor* strategy and the second is *Central HC* criterion for travellers who prefer *VUs* close to them. From a space on the ground floor to another on the top floor, six logical paths are computed according to the *Floor* strategy (Figure 7.3a to f). Two elevators are involved for the six paths. In order to decide on one path, the *Central HC* criterion is applied, and this makes it possible to obtain the final logical path (Figure 7.3f). Generally *Central HC* helps to reduce the number of *Floor* strategy paths, and ensures the traveller moves horizontally in central regions. The central regions normally include salient signs and they are pivots in the building, which provide more information for guidance. The corresponding geometric path is then computed for the traveller shown in Figure 7.3g. Figure 7.3h presents all the geometric paths related to the other five logical paths.



Start Space

(a) Logical Path 1

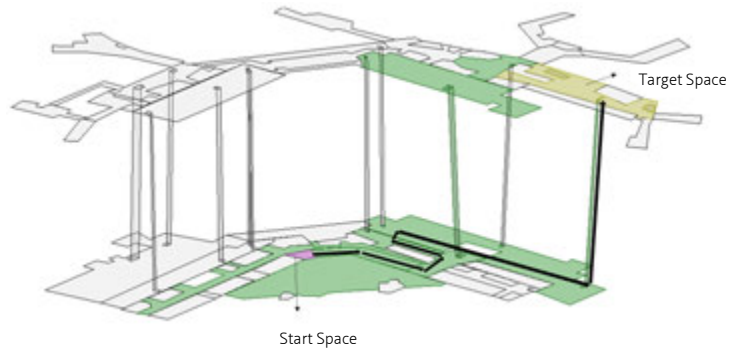

Start Space

(b) Logical Path 2

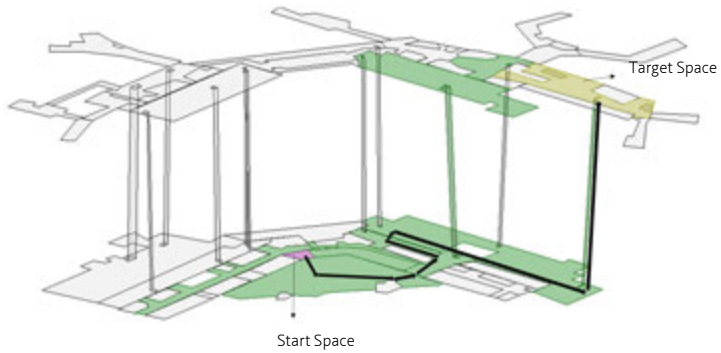

Start Space

(c) Logical Path 3

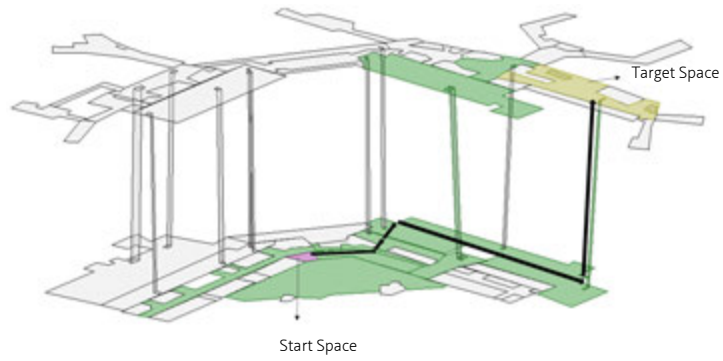

(d) Logical Path 4

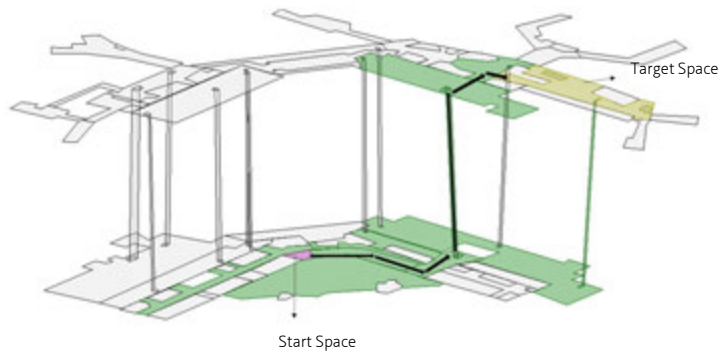

(e) Logical Path 5

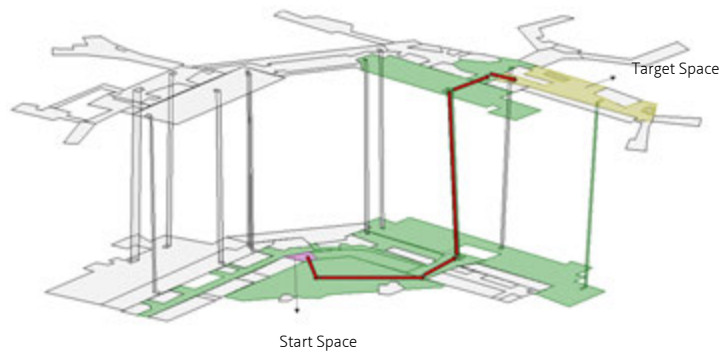

(f) Final Path

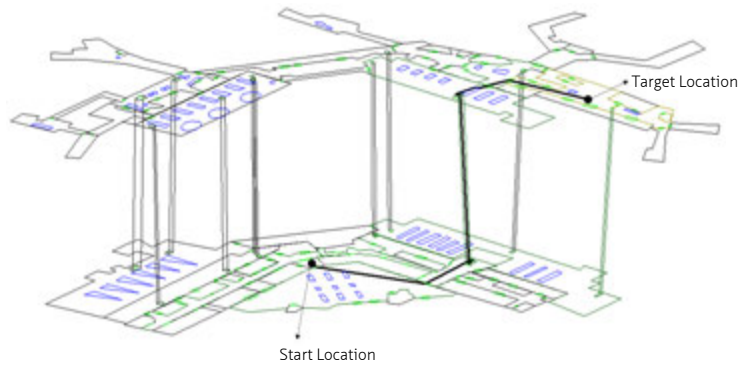

(g)

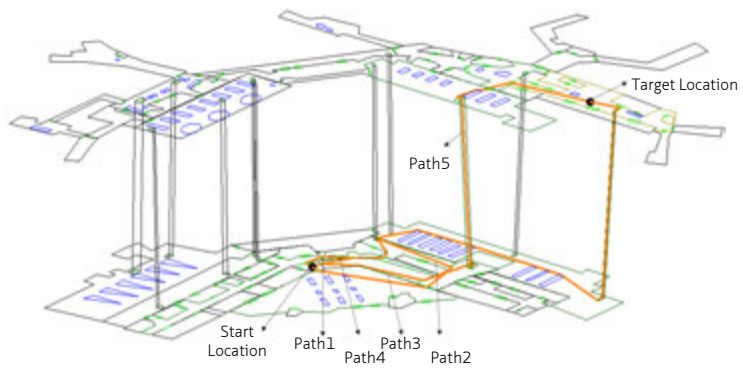

(h)

FIGURE 7.3 Logical and geometric paths of option C3.1 in Schiphol Airport. The logical paths are computed with the Floor strategy. (a) Path 1; (b) Path 2; (c) Path 3; (d) Path 4; (e) Path 5; (f) Final logical path (in red) selected by Central HC criterion; (g) The geometric path based on the final logical path; and (h) The other geometric paths (in orange) derived on the unselected logical paths.

By comparing figures 7.2 and 7.3, it is noticeable that there are fewer logical paths in *OTB* than in *Schiphol Airport*, because *OTB* has far fewer *VUs*, which limits the options for switching floors. Generally, more *VUs* in a building may increase the number of paths for the *Floor* strategy (see Figure 7.3). This is an indication that the *Floor* Strategy is more suitable to be applied to cases that contain many *VUs*. Otherwise, a common routing approach is enough to provide paths crossing two floors (e.g., the shortest path).

However, the resulting geometric path in Figure 7.3g is longer than the shortest geometric path derived from another logical path (Path 5 in Figure 7.3e). Table 7.3 presents the length of the six geometric paths; the final path is 162.21m long but the shortest one is 159.35m (*Unselected Path 5*). Paths computed by the two-level routing are different to the shortest path in a complete geometric network, because distance is not the primary consideration. This routing result shows that a geometric path of two-level routing is generally longer than the shortest path.

TABLE 7.3 The length of different geometric paths derived from the logical paths of the Floor strategy in Schiphol Airport.

	The Final Path	Unselected Path 1	Unselected Path 2	Unselected Path 3	Unselected Path 4	Unselected Path 5
Length (m)	162.21	189.61	224.16	227.26	185.03	159.35

§ 7.2.2 Routing with ordered SOIs and one size

For option C3.6 in *OTB*, the user profile is [Adult, Walking, Visitor, 0.5m] (see Table 7.2). One can consider the following scenario: a visitor wants to meet two persons in different parts of the building. The user wants to specify SOIs and POIs as the first person's office and his desk, and set the second person's office and his desk as the target. For this case the *SOI* strategy is applied to compute a logical path followed by computation of a geometric path.

The start space is on the third floor and the target space is on the second floor (Figure 7.4a). A POI and the related SOI are set on the first floor. The user receives one logical path consisting of two parts: the first half is from the start space to the SOI, and the second half is from the SOI to the target space (Figure 7.4a). Geometric paths related to the two parts are computed and illustrated (Figure 7.4b). Because the building is regularly shaped, the sequence of the highlighted spaces (the logical path) roughly reflects the shape of the geometric path (Figure 7.4). In such cases the user may not need the geometric path since she/he can follow the logical path.

In *Schiphol Airport*, the scenario of option C3.6 can be associated with the following scenario: a traveller wants to get some food in a cafeteria, before she/he walks to a check-in point. The traveller's profile is [Adult, Walking, Visitor, 0.6m]. The *SOI* strategy is implemented for this scenario where SOIs are the cafeteria and the space of a check-in point (the target) (see Figure 7.5).

The start space, the SOI and the target space are used to compute logical paths with the *SOI* strategy. This results in one logical path only and the related geometric path

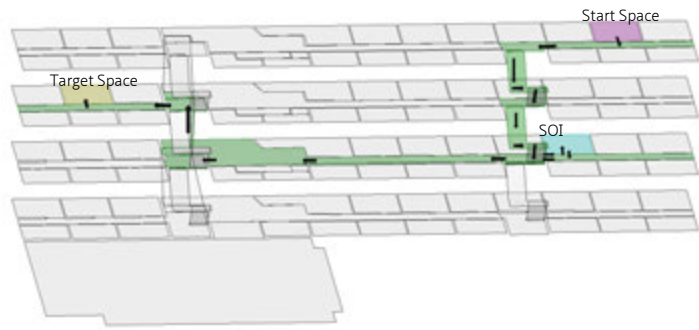

(a)

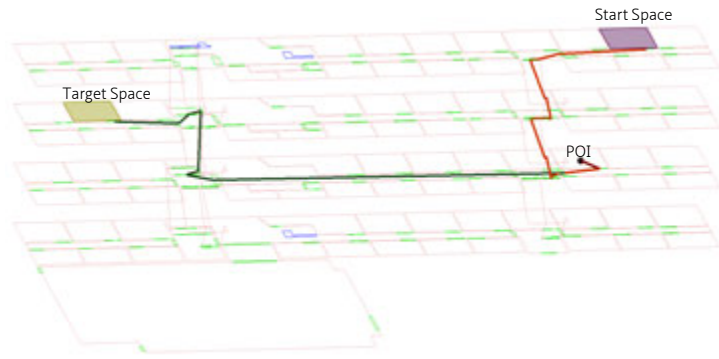

(b)

FIGURE 7.4 Option C3.6 in *OTB*. (a) The logical path. Black arrows indicate the direction of motion; and (b) Corresponding geometric path. The first half is in red to the POI, and the second half in dark green.

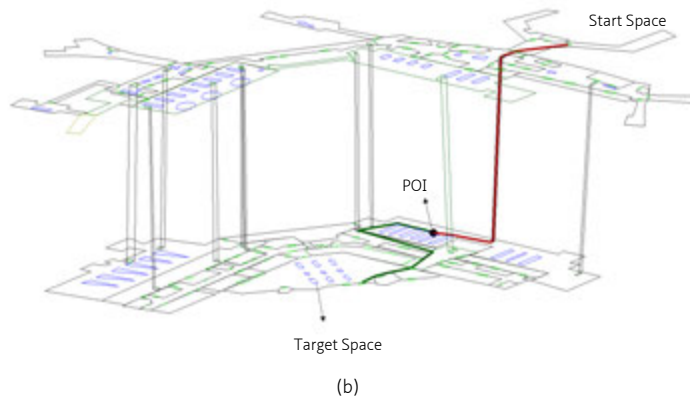
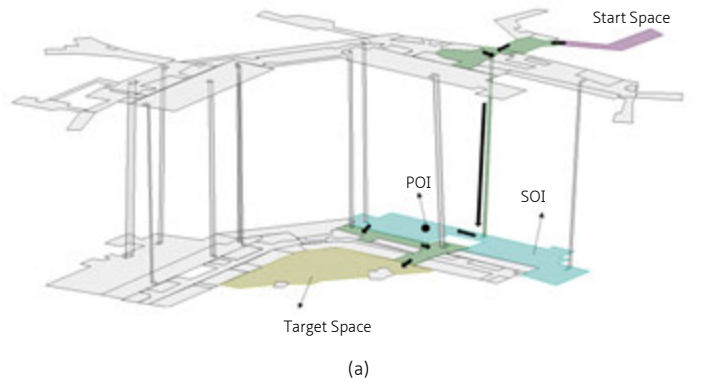

FIGURE 7.5 Option C3.6 in *Schiphol Airport*. (a) The logical path. Direction is indicated by black arrows; and (b) Corresponding geometric path. The first half is in red, and the second half in dark green.

(Figure 7.5). The shapes of the logical path (highlighted spaces) and the geometric path in the airport are not quite the same. The spaces in this building are wider and more geometrically complex (*i.e.*, not square rooms and corridors with small sizes), and they contain many obstacles that disturb the geometric path. This is an indication that a geometric path can be very useful in large spaces.

By comparing figures 7.4 and 7.5, one can find that spaces in the logical path of option C3.6 depend on the ordered SOIs. Though *OTB* is much smaller than *Schiphol Airport*, the logical path in *OTB* (Figure 7.4) includes more spaces (twenty three) than those (nine) of *Schiphol Airport* (Figure 7.5). In such cases, geometric paths have to be computed to determine the accurate length regarding their related logical paths. More spaces on the logical path might imply that the building is subdivided in detail and that the geometric path may not be very different to the logical path.

§ 7.2.3 Routing with ordered SOIs and changing sizes

An interesting option is C3.3 which involves ordered SOIs and different sizes of the same user. Changes of user size has not been considered in research so far. For the testing purpose, in *OTB* and *Schiphol Airport* SOIs are specified far from each other, which increases the number of spaces covered by computed logical paths.

Option C3.3 is implemented in *OTB* with the user profile [Adult, With-Wheeled-Devices, Maintenance Worker, (0.8m, 0.5m)]. Suppose a maintenance worker needs to check electrical wiring in the building, she/he drives an inspection vehicle and finishes the check, then the worker walks down to the ground floor and leaves the building. Thus the routing involves two user sizes: the first one is 0.8m (with the vehicle) and the other one (alone) is 0.5 m. The SOI strategy is also used in option C3.3 since the location of the user size change refers to a SOI. Note, *OTB* contains almost no obstacles, and therefore the geometric path looks direct and simple (Figure 7.6).

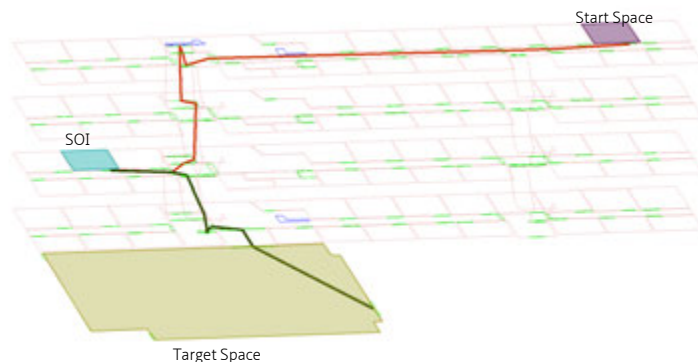

FIGURE 7.6 Option C3.3 in the old *OTB* building. The geometric path from the start space to the SOI with size 0.8m (in red), and the path from the SOI to the target space with size 0.5m (in black).

A possible scenario for option C3.3 in *Schiphol Airport* could be: an airport staff member who takes care of transportation of customers' suitcases with a trolley and needs to move personally checked-in oversized baggage to different ports. The staff's profile

is [Adult, With-Wheeled-Devices, Administrator, (0.5m, 1.2m)]. Therefore, the staff needs elevators and her/his user size is with respect to the oversized baggage. The staff's size changes from 0.5m to 1.2m. The SOI strategy is applied to this case. The first half of the geometric path is for size 0.5m (the staff), and the second part is for size 1.2m (the staff with devices, see Figure 7.7).

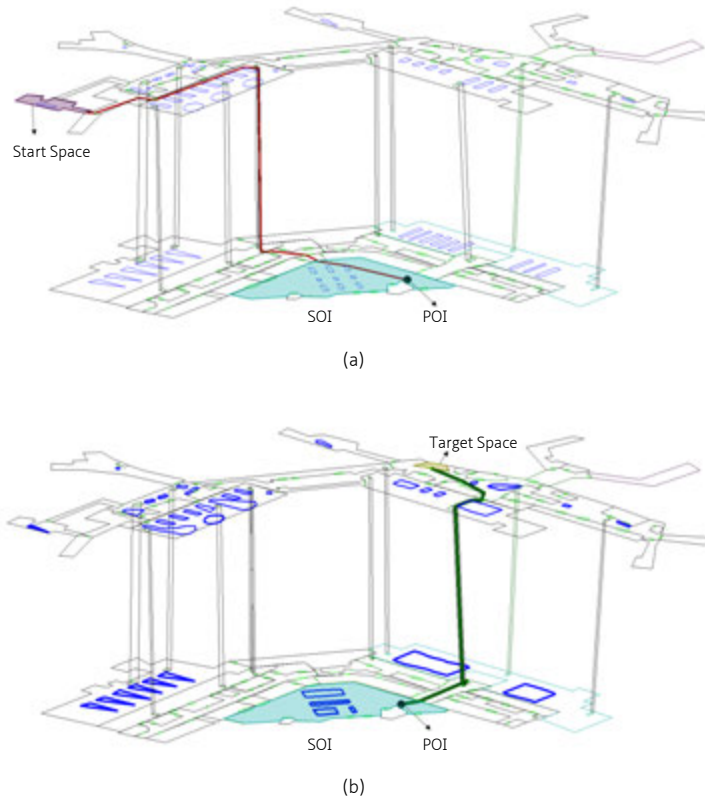

FIGURE 7.7 Option C3.3 in *Schiphol Airport*. (a) The geometric path from the start location to the POI for 0.5m (in red); and (b) The geometric path from the POI to the destination for 1.2m (in dark green). The bold polygons represent the newly grouped obstacles.

When a user size changes in a building, the geometric network has to be updated for routing, because edges of the network are changed. In order to investigate the computational load of geometric network generation, computational costs of the two-level routing are compared with routing in a complete geometric network. In option C3.3, when the user size changes at a POI, two-level routing computes the next logical path and group obstacles in the spaces of the logical path according to the new size, and then computes the geometric path. The computational cost on a complete geometric network consists of the following steps: 1) grouping obstacles (see Chapter 5); 2) recreation of a complete geometric network (see Chapter 6); and 3) routing on the new network. The cost of path computation is mostly influenced by grouping obstacles, *i.e.*, more obstacles increase the computational cost.

Table 7.4 lists the comparison of computational costs of the two approaches for the old *OTB* building and *Schiphol Airport*. *Segment* refers to the two parts of a geometric path (see the column *Size*). The column *Total cost* shows the entire routing cost. *Cost ratio* shows the cost ratio of two-level routing to routing in the complete geometric network. In both buildings, the two-level routing approach is significantly faster (1.59s and 1.19s) for a quick change of the user size. If the whole geometric network is updated to compute the geometric path, the process is prolonged (10.61s and 4.73s). The creation of a complete geometric network of *OTB* (4.73s) is shorter than that of the airport (10.61s), because *OTB* contains few obstacles. The geometric network creation in *OTB* saves the cost of grouping obstacles and obtains a simpler geometric network.

TABLE 7.4 The cost to compute geometric paths regarding routing option C3.3 for *Schiphol Airport* and *OTB*. The unit is second(s).

Building	Segment	Cost of two-level routing (s)	Total cost (s)	Cost of routing with complete geometric networks (s)	Total cost (s)	Size (m)	Cost ratio (%)
Schiphol	Space 23 - 14	1.13	1.59	7.498	10.61	0.5	14.99
	Space 14 - 35	0.458		3.108		1.2	
OTB building	Space 117 - 31	0.934	1.19	2.506	4.73	0.8	25.16
	Space 31 - 0	0.253		2.226		0.5	

As shown in Table 7.4, it is not suitable to obtain geometric paths by updating the complete geometric network, when a user size frequently changes (e.g., keeps transporting different luggage in the airport). However, if one knows the range of size changes in advance (e.g., from 0.4 m to 1.0m with 0.1 m intervals), the pre-computed complete geometric networks can still save time especially for frequent routing requests.

The *OTB* building contains only two obstacles and thus they have little influence on a geometric path. Therefore, the geometric networks for sizes 0.5m and 0.8m have no obvious difference. In such an environment, user size change has little influence as long as the maximum user size fits the openings (e.g., the user can pass through doors). Comparing the cost ratio (the column *Cost ratio* in Table 7.4) of the paths in the two buildings, two-level routing in *Schiphol Airport* is more efficient (14.99%) than for *OTB* (25.16%). As mentioned before, this is because *OTB* has few obstacles, and thus less time is needed to process obstacles and compute the complete geometric network.

Changing user size is a kind of real-time information. Although it is not reasonable to enumerate and store geometric networks for all possible user sizes, in some special environments (e.g., an employee in a factory manipulating different devices) one may frequently encounter a situation where there needs to be an update or an *ad-hoc* computation for geometric networks and paths. When geometric networks are available for different user sizes, the test in *Schiphol Airport* still shows that the two-level routing is a more economic method than routing on the complete geometric network (see Table 7.4). Considering the computational cost reduction is more efficient in *Schiphol Airport* (14.99%) (see Table 7.4), it can be qualitatively concluded that the two-level routing approach can achieve a better performance in complex buildings.

TABLE 7.5 Involved points of geometric networks with regard to option C3.3 in *Schiphol Airport* and *OTB*.

Type	Part of geometric path	Schiphol Airport			OTB		
		Partial geometric network	Complete geometric network	Ratio (%)	Partial geometric network	Complete geometric network	Ratio (%)
Point	First	1945	5118	38.00	612	2809	21.79
	Second	746	5170	14.43	743	2854	26.03

In order to evaluate the data amount of two-level routing, statistics (see Table 7.5) are given on the number of points used for geometric networks in option C3.3. The sub-column 'Partial geometric network' refers to geometric networks derived by two-level routing. The sub-column 'Ratio' shows the ratio of the point numbers of two-level routing to those of related complete geometric networks. As introduced in Chapter 3, geometric nodes are indoor transfer locations (e.g., door centres) and POIs, and a geometric edge is the shortest path between two nodes as a polyline. Besides the geometric nodes, each geometric edge may contain intermediate points such as obstacle vertices and corners of spaces. In addition, points of *INSM* refer to its polygons of *NavigableUnit (NU)*, *Opening (OPN)* and *Obstacle(OBS)*. For example, a rectangular *NU* is represented by a rectangle of 4 points.

In *Schiphol Airport* and *OTB*, all the points are counted for geometric networks derived by two-level routing, the complete geometric network, and the *INSM* (see Figure 7.8). In the statistics of *Schiphol Airport*, the first part represents the largest ratio of points (38.00%) of the complete geometric network for size 0.5m, and the second part has only 14.43% points of the complete geometric network for size 1.2m (see Table 7.5). In *OTB*, the larger ratio of points (26.03%) is in the second part. This indicates that two-level routing needs less half storage loads compared to the complete geometric network.

By comparing the points of the complete geometric network and its *INSM*, one can find that the complete geometric network has far more points than the *INSM* (Figure 7.8). Regarding the two complete geometric networks (for two different sizes) in *Schiphol Airport*, both the point numbers (5118 and 5170) are much more than that of the *INSM* (1947). In the old *OTB* building, the point numbers (2809 and 2854) of both the complete networks are considerably more than that of the *INSM* (1714). This fact shows that the complete geometric network carries the largest data amount, which needs to be considered when storage is sensitive (e.g., a mobile application).

Compared to *OTB*, the complete geometric network of *Schiphol Airport* has far more points (5118 and 5170) (Figure 7.8), which indicates the interior of *OTB* is less complex (e.g., fewer obstacles) than *Schiphol Airport*. The point numbers of two-level routing in both the buildings also support this proposition: *Schiphol Airport* needs more points (1945 and 746) for two-level routing.

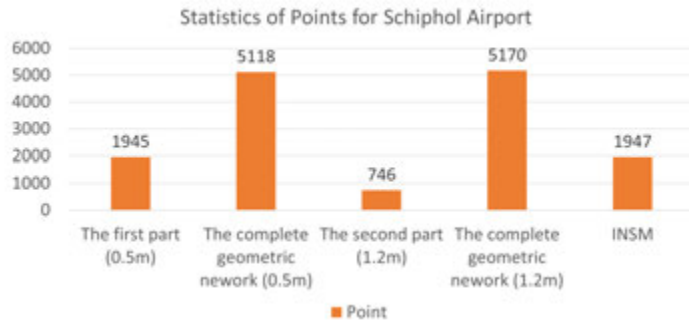

(a)

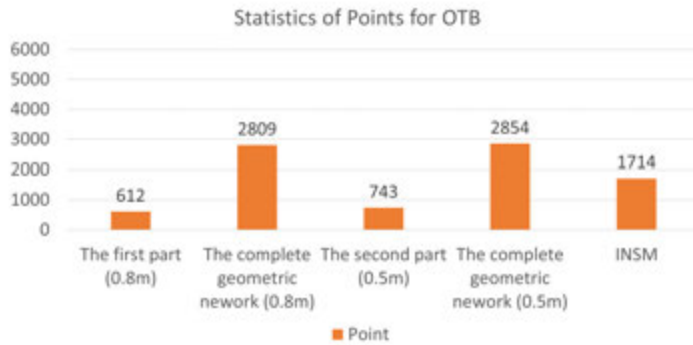

(b)

FIGURE 7.8 Statistics of the involved points for *Schiphol Airport* and *OTB*. (a) Points with respect to *Schiphol Airport*; and (b) Points with respect to *OTB*.

§ 7.3 Mobile application

This section presents a mock-up of two-level routing in a mobile application developed with *Bentley Systems Mobile SDKs*. It refers to Case 2 of Table 7.1. The purpose of the development is to conduct two-level routing in mobile devices in a more convenient way. This test is used to demonstrate the feasibility of the two-level routing approach. In this mobile application, the INSM, the logical network, and a derived complete geometric network are stored in an i-model file with the internal database *ECDB* [Sys16c], i.e., a SQLite [Con16] database. 'EC' represents the term 'business data' which is a Bentley information modelling system, and 'ECDB' is the API to access the EC data. In my implementation, the ECDB file is stored in the client. Thus users can obtain logical and geometric paths even when they are disconnected from the internet. A set of SDKs named Graphite [Sys16c] is adopted for implementation. The two-level routing function is developed in the Navigator Mobile [Sys16c]. Navigator Mobile provides basic interface and functionality to import and visualize graphic data.

ECDB files are designed for applications that work with non-graphic data. 'EC' represents Bentley's information modelling system that involves self-describing non-graphic data. An *ECSchema* defines the data model for an *ECDB* file. The *ECSchema* is represented by a XML-based file. An *ECSchema* consists of *ECClass* and *ECRelationshipClass*, and an *ECClass* contains *ECProperty* as attributes (see Figure 7.9). Relationships within *ECClass* are described by *ECRelationshipClass*. In general, *ECClass* represents tables of the database and *ECProperties* are columns of the *ECClass*, while *ECRelationshipClasses* performs similar to link tables. In addition, a generic concept is used to refer to the primary key and the foreign keys of an instance, i.e., *ECInstanceId*. *ECInstanceId* is the equivalent concept of a primary key. Each *ECClass* has a built-in *ECProperty* called *ECInstanceId* which has no need to be explicitly defined in the *ECSchema*.

```
ECClass ← <ECClass typeName="B2" isDomainClass="True">
  <ECCustomAttributes>
    <PreviousNameArray xmlns="Bentley_Standard_CustomAttributes.01.00">
      <PreviousName>
        <IDName />
        <SchemaFullNameKey:InsideSpaceNavigation.01.00/SchemaFullNameKey>
        <IsNewInThisVersion:True/IsNewInThisVersion>
      </PreviousName>
    </PreviousNameArray>
    <PreviousNameAlreadySaved:True/PreviousNameAlreadySaved>
  </ECCustomAttributes>
  <ECProperty propertyName="ID" typeName="string">
    <ECCustomAttributes>
      <PreviousNameArray xmlns="Bentley_Standard_CustomAttributes.01.00">
        <PreviousName>
          <IDName />
          <SchemaFullNameKey:InsideSpaceNavigation.01.00/SchemaFullNameKey>
          <IsNewInThisVersion:True/IsNewInThisVersion>
        </PreviousName>
      </PreviousNameArray>
      <PreviousNameAlreadySaved:True/PreviousNameAlreadySaved>
    </ECCustomAttributes>
  </ECProperty>
  <ECRelationshipClass typeName="DRModeDofMode" isDomainClass="True" strength="referencing" strengthDirection="Forward">
    <ECCustomAttributes>
      <PreviousNameArray xmlns="Bentley_Standard_CustomAttributes.01.00">
        <PreviousName>
          <IDName />
          <SchemaFullNameKey:InsideSpaceNavigation.01.00/SchemaFullNameKey>
          <IsNewInThisVersion:True/IsNewInThisVersion>
        </PreviousName>
      </PreviousNameArray>
      <PreviousNameAlreadySaved:True/PreviousNameAlreadySaved>
    </ECCustomAttributes>
    <ECProperty propertyName="EId" typeName="string">
      <ECCustomAttributes>
        <PreviousNameArray xmlns="Bentley_Standard_CustomAttributes.01.00">

```

FIGURE 7.9 A snippet of the ECSchema. Structures of ECClass, ECRelationshipClass and ECProperty are shown in the snippet. ECProperty are organized under the ECClass, ECRelationshipClass tags.

Testing data is prepared for the Navigator Mobile which originates from the *Residence* building in *IFC* format (see Chapter 6). Firstly, the house model is mapped into INSM. Secondly, based on the INSM, the logical network and a complete geometric network for users of size 0.5m are computed by the desktop application. Thirdly, the floor plans with the logical and the geometric networks are published as an *i-model* file by using *MicroStation V8i*, which adds the different data in a package of *i-model*. The published *i-model* contains graphic (the INSM and/or 3D building model) and non-graphic data (i.e., *ECSchema*). The *i-model* of the building is the input for the *Navigator Mobile*. Finally the *i-model* is loaded in the *Navigator Mobile*. Through the above steps, Case 2 in Table 7.1 is implemented (i.e., *thick client* in mobile application).

The interface of the *Navigator Mobile* is presented in Figure 7.10 where the 'Browse' option is for selecting *i-model* files. The first step is to select and load an *i-model* from a local disk or servers. Here my local *i-model* is loaded with a 3D building model of *Residence*. Snapshots of the building and the INSM are shown in Figure 7.10. In *Navigator Mobile*, developed functions mainly include options to select, view and measure building geometry. The 3D building and the INSM are stored in different layers and can be selected for visualization in *Navigator Mobile*. This research adds new functions for two-level routing.

Based on the *Navigator Mobile*, functions are added for logical/geometric network generation and two-level routing. Specifically three functions are developed : 1) to select the start and destination by identifying POIs on a plan view of a navigationally enabled *i-model*; 2) to compute logical paths and geometric paths with the *i-model*; and 3) to visualize logical and geometric paths. After loading the *i-model* data in the *Navigator Mobile*, a test is conducted with the two-level routing approach.

Figure 7.11 presents the structure of designed *EC*Schemas of logical and geometric networks. The conceptual models of the logical and geometric networks are implemented as presented in Chapter 3. As mentioned above, the *ECSchema* format provides two types of classes: *ECClass* and *ECRelationshipClass*. *ECClasses* denote the nodes of a logical/geometric network, and *ECRelationshipClasses* are used to represent the edges of a logical/geometric network. The *ECRelationshipClasses* clarify the relationships of two nodes (i.e., connectivity or a geometric edge) and the source and the target of a relationship. For a logical network, a class *Node* is created with two attributes, *Name* and *SpaceType* (Figure 7.11a). The *Name* helps a user to understand indoor spaces, and the *SpaceType* uses values to represent space type according to the *INSM* semantics of a space. For example, different numbers (from 1 to 6) are set to *HorizontalConnector(HC)*, *VerticalConnector(VC)*, *END*, *Stair*, *Elevator* and *Escalator*, respectively. An *ECRelationshipClass Edge* is created without attributes.

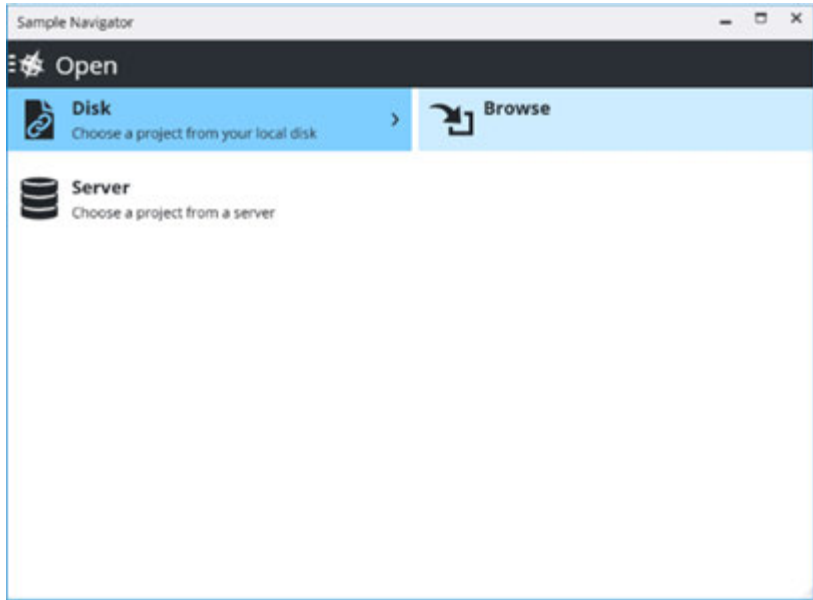

(a)

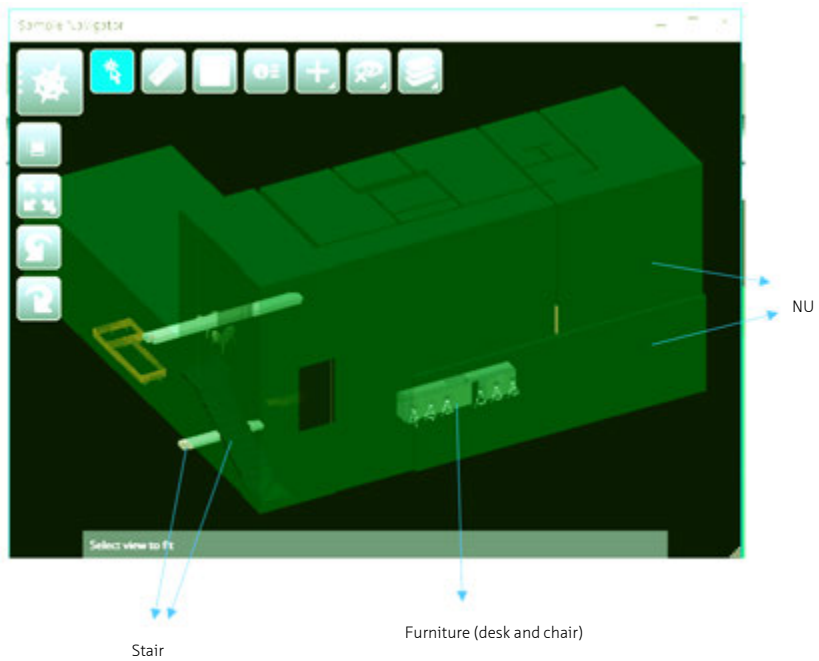

(b)

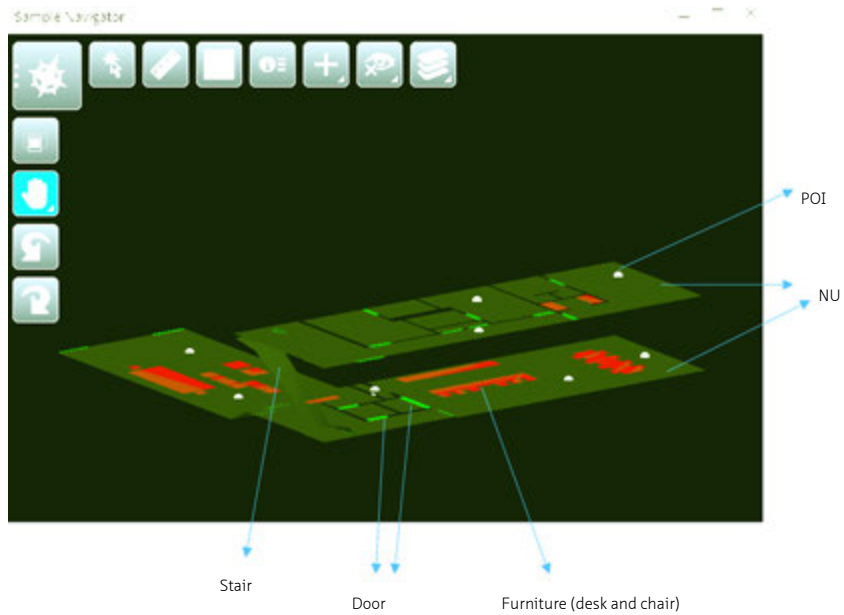

(c)

FIGURE 7.10 Navigator Mobile application. (a) The start interface; (b) The Residence building; and (c) The INSM.

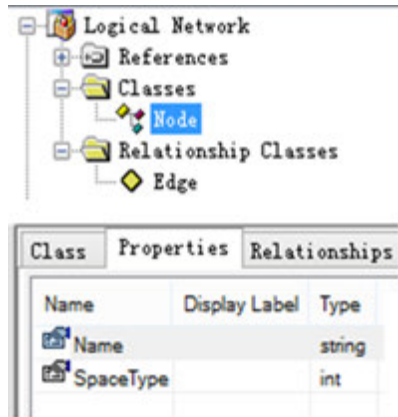

(a)

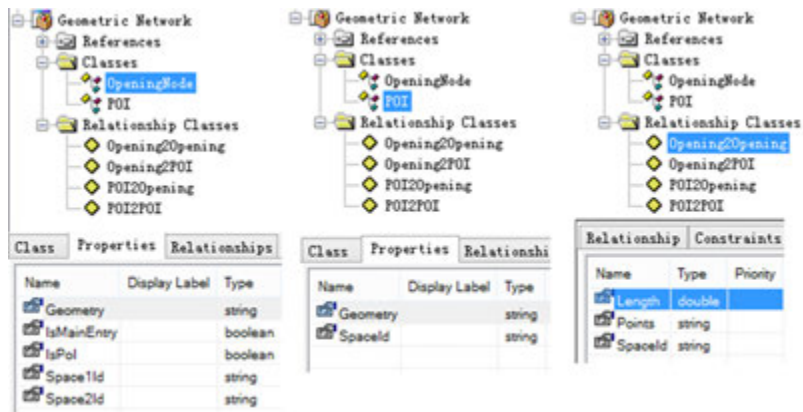

(b)

FIGURE 7.11 Schemas of logical and geometric networks. (a) The schema of logical networks. It contains the ECClass Node and ECRelationshipClass Edge; and (b) The schema of geometric networks.

The ECSchema of geometric networks corresponds to the conceptual model of the geometric network (see Figure 3.16). Two ECSchema classes *OpeningNode* and *POI* represent geometric nodes, and they include the same attributes of the classes *OpeningNode* and *PointOfInterest* in the conceptual model of the geometric network (see Figure 3.16). Here the conceptual models of logical and geometric networks are implemented by the ECSchema. This implementation is illustrated with the UML Physical Model (Figure 7.12 and 7.13). Note that the class *Edge* has two attributes *StartNodeId* and *TargetNodeId* to refer to a directed logical edge (Figure 7.12b). Two connected spaces are mapped to two directed edges when both the directions are accessible.

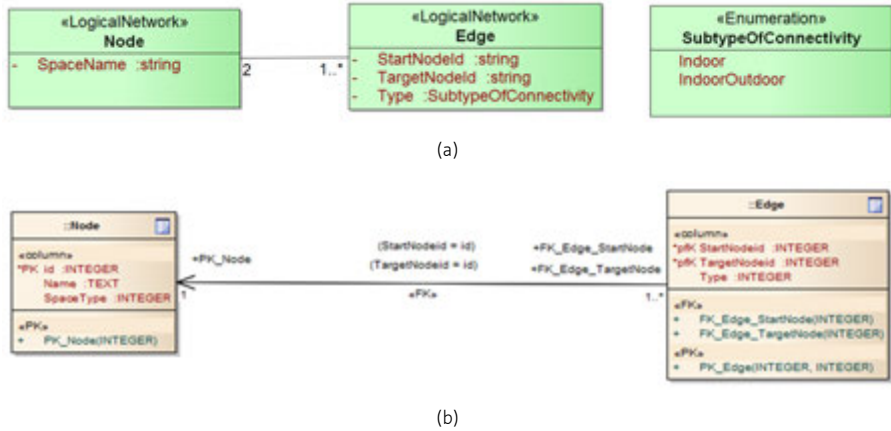

FIGURE 7.12 Data model of mobile implementation of the logical network. (a) The conceptual data model; and (b) The physical model.



(a)



(b)

FIGURE 7.13 Data model of mobile implementation of the geometric network. (a) The conceptual data model; and (b) The physical data model.

Four relationship classes *Opening2Opening*, *Opening2POI*, *POI2Opening* and *POI2POI* represent geometric edges (many to many relationships, see Figure 7.13b). The *GeometricEdge*'s attributes *StartNodeType*, *TargetNodeType*, *StartNodeId* and *TargetNodeId* in the conceptual model are implicitly referred to by the four relationship classes. From the name of the relationship classes one can immediately know the types of start and target nodes (POI or Opening). The four relationship classes include three attributes: *Points*, *Length*, and *SpaceId* (Figure 7.13b). The *Points* stores the coordinates of a geometric edge (a polyline). The *Length* stores the distance of the geometric edge, and the *SpaceId* indicates the space of the geometric edge. The geometric network is a directed graph and paths of both directions between two geometric nodes are referred to by *StartNodeId* and *TargetNodeId*.

As a demonstration, option C3.1 is applied (constant user size without SOI/POI) in this mobile application. The user profile is set as [Adult, Walking, Visitor, 0.5m], which indicates that the *Minimum NU* criterion is applied for the logical path and that the stored geometric network fits the size 0.5m. Figure 7.14 illustrates the prototype of the mobile application. Coordinates are assigned to the logical network so that the nodes are embedded in each *NU*. The start/target locations of a user are selected by identifying two POIs in the *i-model*.

Figure 7.14c presents the complete geometric network in all spaces. Based on the computed logical path on the *Minimum NU* criterion, option C3.1 is conducted to obtain the geometric path between the start and target locations (see Figure 7.14d).

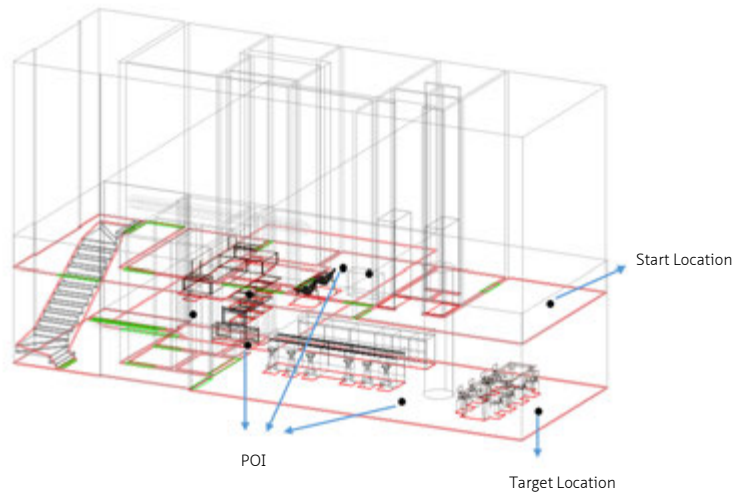

(a)

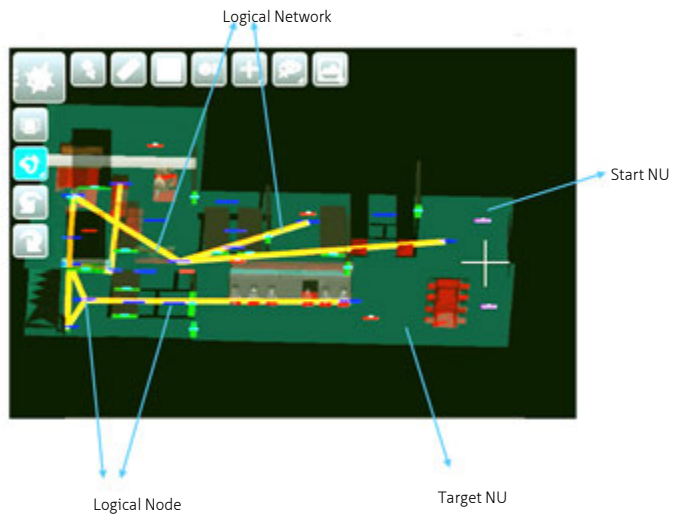

(b)

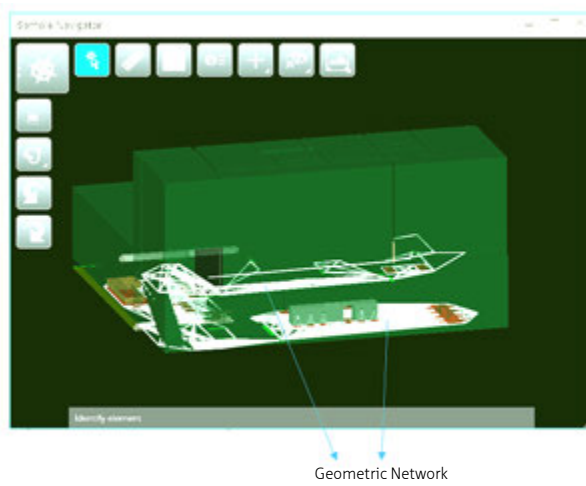

(c)

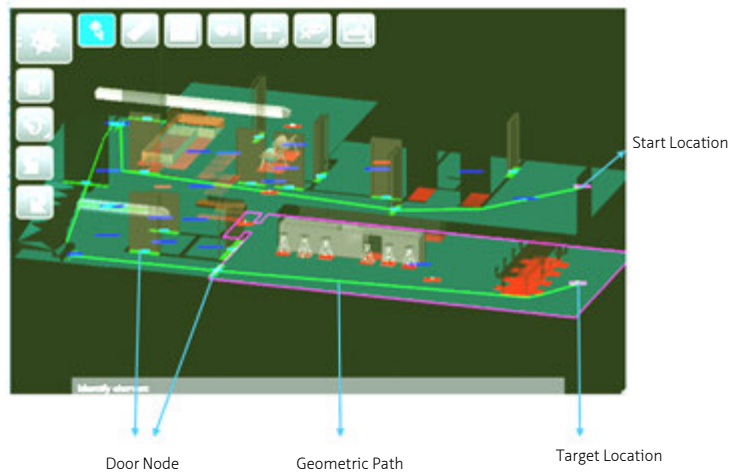

(d)

FIGURE 7.14 Demonstration of two-level routing in mobile application. (a) The Residence building; (b) The logical network, represented by a geometric network (in orange) containing both space connectivity and vertex coordinates; (c) The complete geometric network (in white); and (d) The geometric path (in green). The green bars are door centres.

§ 7.4 Analysis of the tests

This section analyses all the results presented in sections 7.2 and 7.3, and provides more details on improving the two-level routing approach and the future development of two-level routing.

Two-level routing is based on an INSM with two derived models – the logical network and the geometric network. The INSM contains the geometry and semantics of indoor spaces. The logical network represents the connectivity among indoor spaces. One can compute a complete logical network, and sub logical networks can be retrieved from it (e.g., according to attributes) on the selected spaces for different users (e.g., visitors and maintenance workers). Given a user size, there is one complete geometric network for all indoor spaces but it is not necessary to compute it for routing. Lots of sub geometric networks can be derived in real-time according to specified spaces and different user sizes. For example, geometric networks are updated (e.g., in the public area for the two-level routing) when a user size or obstacles in the airport change.

Considering different combinations of the logical network and the geometric network, the two-level routing approach is flexible to provide different paths. For example, the logical path can be conveyed to users verbally by describing space names, while the geometric paths in one or more spaces can give a geometrically accurate path for a specific size.

The result of the first experiment in Section 7.2 shows that more logical paths can be found in a large and complex building which contains many *VUs*, such as the building of *Schiphol Airport*. The existence of multiple paths also depends on the location of the start and target spaces. Even in complex building with many *VUs*, it is still possible to obtain just one *Floor* strategy path to certain target spaces. However, more *VUs* in a building do indeed increase the vertical transfer opportunity, which may generate more *Floor* strategy paths from some spaces (see Figure 7.3). The number of *Floor* strategy paths in *Schiphol Airport* and *OTB* indicates that choices of logical paths are more definite in a simple building where multiple routing criteria are not needed. In contrast, routing in *Schiphol Airport* needs ordered routing criteria to reduce logical paths. This comparison manifests that routing with multiple criteria is more suitable for complex buildings.

Generally the geometric paths derived from the two-level routing can be longer than the shortest path in a complete geometric network. The result in Section 7.2.1 has shown that two-level routing does not give the first priority to the distance. According to a user's needs, the routing can result in proper logical paths and longer geometric paths.

The test with option C3.6 (with ordered SOIs/POIs and a constant user size) shows that simple regular buildings most probably contain similar shapes of the computed logical path and the corresponding geometric path. In such cases, a user can recognize and follow these spaces without the geometric path. In contrast, complex irregular buildings, often influenced by the irregular geometry of spaces and indoor obstacles, require the computation of geometric paths. Therefore, it can be concluded that two-level routing is more efficient in complex buildings.

The space number of logical paths is also compared in simple and complex buildings. The logical path in a simple regular building may include more spaces than in a complex building. This result indicates that the length of two different logical paths could not be precisely compared by their related space numbers. This is because a space can be large or very small, and thus geometric paths in two spaces can vary considerably. A logical path with a few spaces may correspond to a long geometric path (e.g., one long corridor), but another logical path with a number of small spaces can derive a shorter geometric path.

The experiment of option C3.3 (with ordered SOIs/POIs and different user sizes) demonstrates that two-level routing can handle the changes of a user size more efficiently, compared to routing with a complete geometric network. In general, two-level routing needs less cost for routing when user sizes change. It is advised to compute geometric paths by conducting two-level routing when the user size frequently changes. Tests in the two buildings show that two-level routing is suitable for buildings with many obstacles. In the airport, the complex building, computational cost is much less than that with a complete network (see Table 7.4).

Generally some issues have not yet been addressed in two-level routing, which are:

- *Multiple resulting logical paths.* Routing in complex buildings possibly derives more than one logical path even with ordered multiple criteria. In such cases, this research would leave all the resulting logical paths to a user. In the future, a method could be developed to ensure the only logical path, which can save a user's effort to decide the path to be followed. For example, besides using multiple ordered criteria, different criteria can be weighed and organized in an objective function for optimization.
- *The relationship between user profiles and routing criteria.* This research designs a simple user profile and assumes the connections between different profiles and ordered routing criteria. To gain more realistic routing results, it is necessary to investigate genuine user needs by questionnaires. Then a more reasonable relationship would be provided for different users.
- *Customized geometric paths.* So far user needs on geometric paths have not been considered. These paths are computed with the *Dijkstra* algorithm [Dij59] in a geometric network. In the next steps, semantics in geometric networks could be used to realize user requests. For example, geometric nodes can represent a door, a window, a corner, or other POIs. Considering a user's preferences on geometric paths, routing criteria can be developed in geometric networks (e.g., the closest door or the minimum corners).

In this chapter, the two-level routing mock-up in the mobile application is only an initial experiment. This application is developed as a thick client (i.e., Case 2 in Table 7.1), and all the computation are conducted on the client without the internet. It demonstrates that two-level routing can be added in a mobile application. It is currently only for routing with one user size. Though theoretically it can store more than one complete geometric network for different user sizes, this may challenge the computational ability of mobile devices with a larger dataset. An alternative may be labelling the maximum size for each edge in the complete geometric network. Then paths can be computed for different given user sizes.

As future work, it is recommended to experiment with other mobile options of the two-level routing in Table 7.1. The current implementation can be improved by using servers to conduct two-level routing. The two implemented thick client cases (Case 1 and Case 2) provide two-level routing only on the client side. Based on the Client-Server structure, with limited effort one can implement the mobile applications of cases 3, 4 and 5 (see Table 7.1). The three cases represent thin clients where two-level routing is conducted on the server side. These thin client applications can provide a user with an updated INSM and related logical and geometric paths, which support data synchronization with clients. The two-level routing can be moved to a server, and then the mobile application is used as a visualization tool. The INSM and the logical network are stored in the server, and geometric networks can be either pre-computed and stored (cases 3 and 4), or derived 'on the fly' (Case 5).

§ 7.5 Summary

In this chapter, five cases have been proposed according to the methods of model creation (pre-computed or 'on-the-fly'), model storage (on clients or servers) and implementation platform (desktop or mobile) (see Table 7.1). The first case is for desktop application which is a thick client application (all data and computation only on the desktop client without server). The second is also a thick client application (without server) but implemented for mobile application. The third case includes all the data stored on the server side, but the mobile client also stores a copy of the *INSM* and the logical network. In the fourth case, all the data is stored in the server, and none in the mobile client. The fifth case only stores the *INSM* and the logical network on the server side, and none in the mobile client.

The first two cases are implemented as a desktop and a mobile application, respectively. Tests on the two applications answer the following research sub-question:

6. *How are the new proposed user-related paths implemented and applied to realistic cases?*

In the desktop application, user-related paths are presented with two-level routing in the simple *OTB* building and the complex *Schiphol Airport*, which shows the generation of logical and geometric paths according to user preferences on logical paths, ordered SOIs and POIs, and user sizes. The logical path excludes unrelated spaces, and then the geometric network is created in the selected spaces for routing. In Section 7.2 three routing options are applied to the desktop application, *i.e.*, option C3.1 (constant user size without SOI/POI), option C3.6 (constant user size with ordered SOIs/POIs) and option C3.3 (changing user sizes with ordered SOIs/POIs). From the tests, one can conclude that routing with multiple criteria on the logical network is more suitable for a complex building, and that two-level routing can process changes of user size more efficiently compared to using the complete geometric network.

Section 7.3 presents the development of the mobile application with *Bentley Systems* special tools such as *i-model* and *ECDB* (Bentley's API to access EC data) [Sys16c]. Option C3.1 for two-level routing is implemented in the *Residence* building to obtain a

geometric path, which demonstrates the feasibility of this thick client application for users without an internet connection.

Section 7.4 discusses the options not addressed in this implementation, including the reduction of multiple resulting logical paths, validation of the relationship between user profiles and routing criteria, and consideration of the semantics of geometric nodes for specific user needs. These topics will be left for future work. In the following chapter conclusions of this research will be drawn.

8 Discussions and conclusions

This final chapter summarizes the main findings of this PhD research, and proposes future work to continue the research. In Section 8.1, the answers to the research questions (Chapter 1) are provided. Section 8.2 presents an assessment of the proposed two-level routing approach. Section 8.3 lists recommended research topics as the future work of this PhD research.

§ 8.1 Outlook on this research

Complex buildings most often contain many indoor spaces with irregular shapes and indoor objects, which requires user-related paths in addition to the shortest path. Human users have different preferences for paths through indoor spaces and locations. The semantics of indoor spaces provides a way to measure the fitness of spaces to a user. In addition, a user's size needs to be considered to find an accessible detailed path. Thus a user embodying user preferences and sizes should be applied to indoor routing. The resulting paths are user-related and thus differ in terms of users. All the above topics are investigated in this thesis under the following main research question:

- **What indoor routing approach can provide accessible paths according to human user preferences by using the semantics of indoor spaces, in addition to using building topology and geometry?**

I have devised and tested an innovative approach for indoor navigation named the *two-level routing approach*. This approach can generate paths based on the proposed *Indoor Navigation Space Model (INSM)* semantics of indoor spaces and space geometry. The approach can also adjust indoor routing according to user needs, such as passing through ordered SOIs, POIs and obstacle-avoidance. The resulting paths are adaptable to users with varying sizes.

The sub-questions are repeated and the answers are elaborated in the text below.

1. *What kind of information, data models and routing algorithms has been used and developed so far, and what are their limitations for large complex buildings? (Chapter 2)*

To complete the indoor routing task, one needs the semantics, topology, and geometry of a building. Building models (Section 2.1) as data input are required, such as CAD files of floor plans, standard data of city models (*i.e.*, *CityGML*) and standard data of buildings (*i.e.*, *Building Information Model (BIM)*). However, CAD files always lack the semantics of indoor spaces and contain very primitive geometry (*e.g.*, lines). Semantic models of *CityGML* [GKNH12] and *BIM* [IAI16] contain abundant space semantics and accurate geometry of the spaces (*e.g.*, 2D surfaces or 3D solid). However, the semantic models are not specifically for indoor navigation and cannot be directly used for navigation network generation. Another semantic model named *IndoorGML* focuses on indoor spaces and their connectivity for navigation networks [LLZ⁺14]. But the network

of navigable spaces (*i.e.*, its *Navigation* module) is not compulsory for *IndoorGML*, and the navigation networks have to be derived from building models.

Space semantics should be considered in the generation of navigation networks. There are many ontologies which define semantics in different ways [TAKHO6, DGK09a, KG10, GZ11a]. In order to apply any of the ontologies, one needs to consider the subdivision approach of building (*e.g.*, based on the structure or functions of spaces). However, the method of subdivision is not clear, because the semantics of the reported ontologies are either too general or too detailed for different types of building.

Navigation models (*i.e.*, 2D/3D networks or grids) can be generated from the building models for path computation (see Section 2.2). In general, there is no standard navigation model for every case of indoor navigation. Therefore, a navigation model needs to be selected in a specific context. For indoor pedestrian navigation, navigation networks are extensively used. For instance, the *Straight-Medial Axis Transformation (S-MAT)* modelling method [EE99, CL09] is frequently applied to indoor obstacle-absence scenarios to get a medial axis network of spaces. Though Mortari *et al.* [MZLC14] propose a similar network model to improve the *S-MAT* methods to incorporate obstacle, such networks are not flexible enough to handle indoor obstacle changes. In contrast, *Visibility Graph(VG)*[Lat91, dBCvKO08] does not follow the shape of indoor spaces, but provides direct paths among locations. Some research of indoor pedestrian navigation employs *VG*-based methods for indoor obstacle scenarios, and the results reflecting the *VG*-based methods can better deal with indoor static obstacles [HBK⁺10, KBH12, SGS12].

Although shortest-path algorithms such as *Dijkstra* [Dij59] and *A** [HNR68] are widely used for indoor routing, many researchers propose some *ad-hoc* routing methods and routing criteria depending on specific navigation models and user requirements (Section 2.3). Except *distance*, *travel time* or *number of turns*, other non-metric factors are considered (*e.g.*, *cognitive similarity*, *temperature*, and *visual signs*). Some pedestrian-related paths are also defined, such as 'feasible' and 'comfortable' paths for a wheelchair user [DGK09a], *least-effort* and *least-visible* paths [LZLF08, CWSC14]. There are routing methods defined on specific navigation models or structures, such as *cactus tree-based* routing [WMY07], routing on *Octree* structure derived from point clouds [RVZ16], *etc.* Pedestrian wayfinding research (Section 2.4) presents some heuristics about human wayfinding behaviours, which can be adopted to design routing criteria. However, two issues are seldom discussed for indoor pedestrian routing: 1) routing with multiple criteria; 2) dimension/size of pedestrians.

2. What data and navigation model is appropriate to represent the semantics, topology and geometry of indoor spaces? (Chapter 3)

I proposed routing for two types of network, *i.e.*, the logical and geometric networks. As mentioned before, this thesis uses the network model. The logical network sustains the semantics of indoor spaces and their connectivity. The geometric network maintains the accessible edges between geometric nodes for a user, which is derived from the geometry of buildings. This research has shown that separating the semantic and geometry increases the flexibility for indoor routing (Chapters 3-5). According to user preferences, routing results on the logical network can filter space candidates and thus generate detailed paths more efficiently.

I proposed the *INSM* model to store the building information and to facilitate the derivation of the navigation networks for path computation. Spaces of *INSM* are linked to nodes and edges of navigation networks, and both logical and geometric networks can be derived from the *INSM*. Indoor obstacles are also maintained in the *INSM*, which is important for obstacle-avoidance of indoor navigation.

Specifically, *INSM* includes abundant semantics of building components based on navigational functionalities. *INSM* also manages the connectivity and geometry of indoor spaces (see Section 3.2). *INSM* captures a set of non-overlapping spaces and their semantics according to their functionalities for indoor routing, such as *VerticalUnit (VU)* and *HorizontalConnector (HC)* as vertical and horizontal passages for human users. Semantics of *INSM* are used to design routing criteria applied to indoor routing in the logical network. In addition to semantics, connectivity of spaces should be detected in building data and explicitly retained in the relationship of *NavigableUnit (NU)* and *Opening (OPN)*. *INSM* also maintains the geometry of indoor spaces which can be stored as 2D polygons or 3D solids. The geometry of indoor spaces and obstacles are required to support the computation of an accessible area for a user and the generation of accessible geometric networks. In my implementation I used 2D polygons to represent navigable surfaces for pedestrian users. The logical network is created by connectivity of spaces and the semantics contained in *INSM*, and the geometric network is derived based on the geometry of each space and the obstacles.

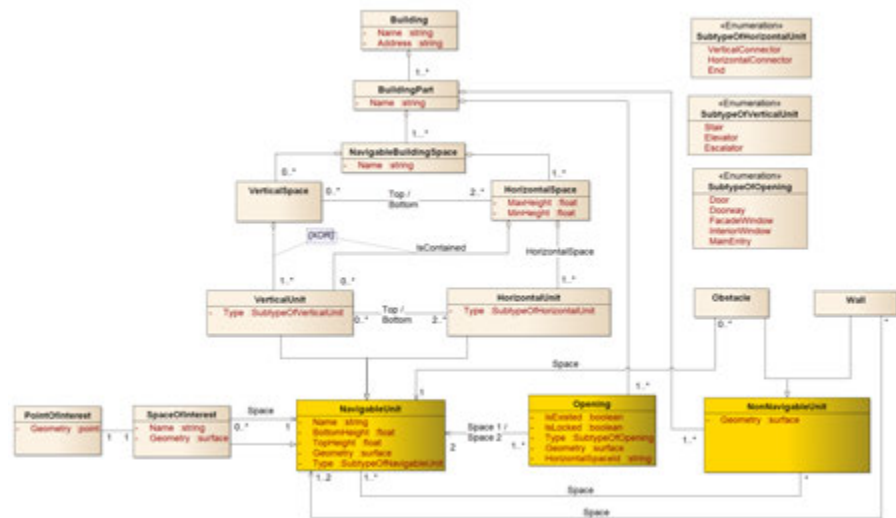

FIGURE 8.1 The INSM model with classes and attributes (same as Figure 3.6 in Chapter 3).

Important attributes of the *INSM* classes are required as well (see Section 3.2). In general, I need to collect the name, top and bottom heights and the floor of spaces from building data. A *NU* needs attributes *Name*, *BottomHeight*, and *TopHeight* (Figure 8.1) to describe the space's name, the lowest height and the top height, respectively. *VU*, a subclass of *NU*, indicates its containment status by its aggregation relationship *Is-Contained* (Figure 8.1) to *HorizontalSpace (HS)*. In addition, the attribute *Type* refers the specific subtype of the *VU* (i.e., *Stair*, *Elevator* and *Escalator*). *HU*, the other subclass

of *NU*, contains the attribute *Type* to specify its subtype (i.e., *HorizontalConnector-HC*, *VerticalConnector-VC* and *End*). The aggregation of *HU* to *HS* reflects the floor of this *HU* instance. An *OPN* has two Boolean attributes *IsExisted* and *IsLocked* which indicate the status of the *OPN* (e.g., *virtual* or *physical*, and *locked* or not), respectively. An *OPN* also includes the attribute *Type* to specify its subtypes (*Door*, *Doorway*, *FacadeWindow*, *InteriorWindow* and *MainEntry*, see Figure 8.1). *OBS* has no attributes since it is an occlusion space just to be avoided.

Based on *INSM*, and its derived models of the logical and the geometric networks, this research proposed an innovative *two-level routing approach* which adopts different types of indoor space, i.e., general free spaces for the logical network, and openings and SOIs for geometric networks. The logical and the geometric network refer to different types of space. A subdivision of a building results in indoor spaces as rooms. The nodes of a logical network represent the rooms and the edges stand for the connectivity of the rooms. The nodes of a geometric network refer to transition spaces occupied by doors and windows and subspaces (SOIs) inside of these rooms, and the edges represent detailed paths among these geometric nodes. This new two-level routing is different from the most common approach in previous research, i.e., hierarchical graphs. For hierarchical graphs, their nodes on different levels are linked to different subdivision results (e.g., floors, sections, rooms, sub-rooms) that are all general free spaces. In contrast, with the two-level routing approach, a detailed path can be relevant to both general free spaces and transition ones (e.g., doors).

3. What kind of user-related paths can be computed with the semantics, topology and geometry of indoor spaces? (Chapter 3)

A number of user-related paths can be computed according to the proposed approach. My two-level routing is not only about the shortest or fastest path in a building. In Chapter 3 I have proposed seven routing options (C3.1 to C3.7) to flexibly compute user-related paths on both the logical (semantics and topology) and the geometric network (geometry). These options stand for different applications with a single destination (see Section 3.4.3): 1) a user can automatically obtain a logical and a geometric path without specifying any SOI and POI (option C3.1); 2) a user can also obtain a logical path and the related complete geometric path through the specified ordered POIs (option C3.2); 3) considering the changes of a user's size (e.g., moving with a shopping trolley), logical and geometric paths can be computed through the given SOIs and POIs in order where the user size varies (option C3.3); 4) when users need geometric paths only in specific rooms instead of a complete geometric path, a logical path can be computed for the users to show the sequence of spaces to be passed and highlight the ones regarding geometric paths as SOIs. Then separate geometric paths in these SOIs would be provided for the users (option C3.4); 5) in some routing cases, a user has to pass through certain spaces in a specific order. Thus, the user would get a logical path through the given spaces sequentially, and the related complete geometric path; 6) in other cases, a user may not only need a logical path through the specified SOIs in order, but also ask for the complete geometric path through the given POIs inside each SOI in order (option C3.6); and 7) if a user finds the computed logical path is not satisfactory, she/he can request a re-computation by assigning ordered SOIs (option C3.7). As a result, the recomputed logical path would cross the SOIs sequentially, and the complete geometric path would be updated as well. In each of the above routing options, the resulting geometric path avoids indoor static obstacles, and it is an accessible path for the user according to the given user size.

4. *What kind of routing criteria can be built (or specified) by using the semantics of indoor spaces? (Chapter 4)*

Six routing criteria and three strategies are designed for routing on the logical network regarding the INSM semantics (see Chapter 4). The criteria are *Minimum Navigable-Unit (NU)*, *Minimum HorizontalConnector (HC)*, *HorizontalConnector (HC) Prior*, *Minimum VerticalUnit (VU)*, *VerticalUnit (VU) Prior* and *Central HorizontalConnector (HC)*. *Minimum NU* is favourable for users who need the fewest spaces to be passed. *Minimum HC* benefits users who want to horizontally cross as few HCs as possible. *HC Prior* is suitable for users who prefer HC nodes and also move as directly as possible to the target. *Minimum VU* has benefits for short vertical movements, while *VU Prior* is for users who prefer VU nodes (e.g., always trying to change floors) and also move as direct as possible to the target. *Central HC* helps users to find paths preserving the high level of accumulated centrality of HCs. With these criteria this thesis investigated different minimization processes on node/edge weights of the logical network, which derives logical paths represented by spaces defined in the INSM model.

In the logical network, I also realize three routing strategies (heuristics of wayfinding): the *floor*, *flat location* and *SOI* strategy (see Section 4.2), by using the *minimum NU* criterion. The *floor* strategy gives priority to movement on the same floor until the location is horizontally close to the destination, while the *flat location* strategy prioritizes arriving at the destination floor and then leads the user horizontally to the destination. The *SOI* strategy ensures a user passes assigned *Spaces of Interest (SOI)* sequentially, which benefits the wayfinding process with high salience areas (i.e., the SOIs).

Tests (see Chapter 6) have presented the routing results on logical routing with four case studies, i.e., a residential building, the Museum of Fine Arts (MFA), Schiphol Airport, and the old OTB building (see Section 6.3.1). The case of the residential building shows that there are no multiple paths between two spaces due to the simple structure of the logical network. The cases of MFA, the old OTB building and Schiphol Airport show that multiple logical paths do exist among different spaces. The routing tests in the MFA and Schiphol Airport result in multiple logical paths, and in both cases the candidate paths can be reduced by using user profiles which refer to a priority order of routing criteria.

5. *Which approach should be used to compute the exact geometric description of accessible paths according to the size of a user? (Chapter 5)*

I proposed a new method to compute accessible geometric paths for a user in a space to avoid obstacles (see Chapter 5). According to the user size, this method consists of grouping obstacles, generating new boundaries of the obstacles, and creating the accessible geometric network for the user. This method allows geometric networks to be automatically derived for individual users with different sizes. A part of the nodes of the geometric networks represent doors which are fixed in the building.

The proposed geometric routing regarding user sizes was tested with three case studies (Section 6.3.2): 1) routing for two groups of users with two distinct sizes in a space; 2) routing for the same user with changed sizes in a space (e.g., handling a device) and 3) generating the geometric network in a given sequence of spaces. The first case showed that obstacles largely change accessible geometric paths for a user, even with small changes of the user size. The second case shows that geometric paths are computed

'on the fly', considering the current user size and changes in the next steps. Different segments referring to distinct sizes are combined into the final geometric path. The third case shows how for a user with a constant size, a geometric network is formed by putting together the subnetworks in four spaces. In other words, this geometric network relies on the selected spaces. This is the way to obtain a complete geometric network in specified spaces for the given user size. In my test the shortest path given by a specific logical path is computed on this geometric network for the user to pass through these specified POIs. All three of the tests manifest how accessible paths can be computed for any user, and how a related geometric network or geometric path can be computed in given spaces.

6. *How are the new proposed user-related paths implemented and applied to realistic cases? (Chapters 6 & 7)*

I proposed five implementation cases according to the methods of model creation (pre-computed or 'on-the-fly') and model storage (on clients or servers). The first one is to pre-compute the INSM and logical network and generate the geometric network 'on-the-fly', and the two-level approach is conducted on a desktop device. All the models are stored on the client side. In this case, path computations can be completely at the client side, which makes it a standalone application (i.e., no server support); in the second case, all the models (INSM, logical and geometric networks) are pre-computed and stored on the client, which is implemented in a mobile application. This case is also a standalone application referring to a mobile device without the internet. A user can compute both logical and geometric paths on the device; the third case includes all the models pre-computed and stored on the server side, and the client also stores the copy of the INSM and logical network. This case is designed for a mobile application where a user can request paths from the server, or independently compute logical paths on the mobile device and follow them when the internet is not available; in the fourth case, all the models are pre-computed and stored on the server, and none by the client. This case refers to a lightweight mobile application where a user just needs to send path requests via the mobile device and receive derived paths from the server; the fifth case only pre-computes and stores the INSM and logical network on the server side, and none at the client. This case is also designed for lightweight mobile applications where the client (the mobile device) sends requests and receives paths from the server. In contrast to the fourth case, in the fifth case the server would compute geometric networks and paths 'on-the-fly'.

I implement the first and the second cases on desktop and mobile applications, respectively. For the first case, I illustrate routing results of the options C3.1, C3.3, and C3.6 (see Chapter 7) in the desktop application. The routing options are conducted in the old OTB building and at Schiphol Airport, representing a simple and a complex building, respectively. The results of routing option C3.1 in the two buildings show that the *Floor Strategy* fits for the cases of Schiphol Airport including many *VUs* for vertical motions, but not for the old OTB building which has much fewer *VUs*, which limits the options for switching floors. Then the *Floor Strategy* from different start spaces on the same floor tends to derive similar paths. The results of option C3.6 in the two buildings show that it is difficult to distinguish the accurate distance of two logical paths by their space numbers. By comparing the shapes of the logical path (indicated by spaces) and the geometric path in the two buildings, I found the path shapes of the two types are similar in *OTB* but not similar in the airport. Compared to the old OTB building, the space shapes of Schiphol are irregular and indoor obstacles curve the geometric

path. Tests with routing option C3.3 in the two buildings show that the cost of path re-computation is influenced by grouping obstacles, when the user size changes at a POI. Two-level routing avoids all obstacles being adopted for grouping and thus is more efficient than recreating the complete geometric network. The cost reduction in the airport is 85.01%, and in the old OTB building it is 74.84%.

For the second case, I presented how the mobile application was developed with Bentley Systems Mobile SDKs. I stored the logical and geometric networks in the Bentley internal database – *ECDb* files. The test building is the residential building in *IFC* format (see Chapter 6). The INSM is generated for the residential building, and also the logical network and the geometric network for 0.5m size. Finally, I publish the three models in *ECDb* files with the geometry of the residential building as an *i-model*, *i.e.*, the data format for *Navigator Mobile* – the Bentley Systems mobile development environment. I visualize the three models in *Navigator Mobile*, and also visualize the computed logical path and geometric path. This test demonstrates that two-level routing can be independently conducted in mobile applications without routing support from a server.

§ 8.2 Advantages and further opportunities of the two-level routing approach

The two-level routing approach has three main benefits:

1. The approach is specifically developed and aimed at complex buildings for indoor routing;
2. It is flexible enough to meet the distinct requirements of users for path details. A user can decide to receive indicative logical paths or comprehensive geometric paths, depending on the complexity of a building, and the user can request accessible paths through any SOI and POI in order;
3. The two-level approach can save computational cost by avoiding the recreation of the whole geometric network of a building, in light of different user sizes.

The two-level routing approach includes clear routing criteria and more routing details than hierarchical graph methods. As a modelling method, hierarchical graphs [HD04, JM05, LOS06b, SSO08, YCDN07, RWS11] represent indoor environments according to the cognitive understanding of space hierarchy. These previous studies address this hierarchy construction, but seldom mention routing details on hierarchical graphs, especially for complex buildings.

The first experiment in Section 7.2 shows that the large and complex Schiphol Airport contains multiple logical paths among its spaces due to a number of *VUs*. The test also manifests how routing with multiple criteria is suitable to be applied to the complex building, which provides fewer logical paths according to a user's preferences.

Another test with option C3.6 (Section 7.2) is conducted on the simple OTB building. Even without the resulting geometric paths, the computed logical path (a sequence of spaces) is enough to guide users in such a simple building. In a complex building, irregular shapes of spaces and obstacles curve the shape of a geometric path so that only the logical path cannot provide enough details to direct the motion of the user. Based

on the given level of details, the two-level approach can be flexibly adjusted and then delivers the requested path form — logical or geometric paths, or both. The resulting geometric paths are determined by logical paths derived by these proposed routing criteria and user preferences. The geometric path is the shortest path in the geometric network regarding spaces indicated by the logical path.

The last experiment of routing option, C3.3 (see Section 7.2), demonstrates two-level routing can process changes of a user size with less time cost, in contrast to routing on a complete geometric network. In summary, two-level routing may not generate the shortest path in the geometric network of all spaces, but it can flexibly provide logical and geometric paths according to user preferences and sizes, and can adjust the generated paths in a limited time.

The proposed two-level routing approach has the following features:

- Supports routing in different abstraction forms of a building (Chapter 3). The INSM model allows two types of routing network to be derived – pure logical and geometric. The logical network contains topology and semantics of indoor spaces, and the geometric network provides accurate geometry for paths. A consistent navigation model is formed with the two networks, *i.e.*, the conceptual and detailed levels (Chapter 3).
- Supports routing on a logical network and thus assists the generation of a conceptual path for a user in terms of space sequence. Routing criteria are designed based on the INSM semantics of spaces, which can generate logical paths similar to wayfinding results such as minimizing *VU* or *HC* (Chapter 4).
- Considers the size of users and results in obstacle-avoiding paths (Chapter 5). The geometry of static obstacles should be stored in the INSM model, and geometric networks can be generated to avoid obstacles for given users.
- Supports routing on both the logical and the geometric network, which can generate geometric paths based on user-specific logical paths, or re-compute logical paths when geometric paths are inaccessible (Chapter 7). This routing is an addition to the common routing methods such as the shortest path computation.

Two-level routing has shown its ability to flexibly provide accessible paths on user demands. As addressed before, a single complete network cannot provide flexible routing for different types of user. Compared to hierarchical graph methods [HD04, JM05, LOS06b, SSO08, YCDN07, RWS11], my approach clearly defines the criteria on the abstract level (*i.e.*, the logical network), which cannot be skipped in implementation.

There are five topics which need to be discussed regarding the approach and the current implementation, which should be considered in further developments: 1) to introduce other routing criteria; 2) to visualize realistic paths if necessary; 3) to consider subdivision to get spaces of similar size; 4) to consider indoor moving obstacles; and 5) to include real-time applications. The details are listed as follows:

First, more criteria can be introduced such as awareness and orientation ability influencing the selection of geometric paths. In this thesis I developed six criteria (Section 4.3) for routing on the logical network, but more can be designed to include other cases. Regarding geometric paths, a path including fewer changes to orientation is

easy to be followed by a user, thus sensing the abilities of users' needs to be parameterized for indoor routing. Sensing abilities is related to how a user leverages her/his visual and hearing abilities to achieve indoor wayfinding, which is an indicator to find the easy-to-follow geometric paths. It is necessary to develop related routing criteria to reflect such preferences.

Second, this thesis denotes geometric paths by the straight-lined representation, since a user can perceive a turn (or a corner) as a remarkable 'landmark' and follow the paths by directions. In other words, I did not generate a 100% precise trail for a user (see Figure 8.2). Although the precise path can retain every detail as a collision-free path, a user can only rely on an accurate tracking device to follow a precise path without deviation. Considering that the current indoor positioning solutions cannot support very high accuracy, a user cannot localize herself/himself accurately in spaces in real-time to follow the precise path. Thus I decided to compute a simplified but informative path, which provides clear directions/turns and then helps users to understand and follow the paths. If a strict precise path is requested by a user, I can further compute the realistic visualization of the path.

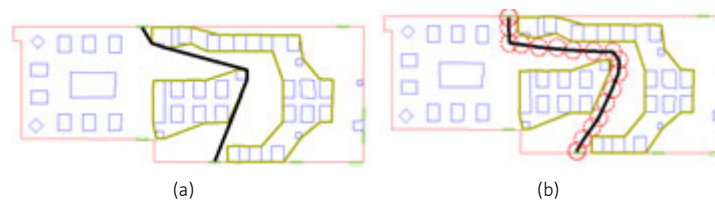

FIGURE 8.2 A comparison of the schematic and realistic representation of a geometric path. (a) Schematic representation; and (b) Realistic representation. The circles represent the trail of a simplified user.

Third, two-level routing is quite related to the subdivision of a building. If a subdivision results in a few large spaces, then routing in the logical network would provide less information and routing in the geometric network can supplement more details on the computed path. In contrast, when many small spaces are derived from a subdivision, routing in the logical network can already outline the path with these spaces. For example, the shapes of logical paths in the *OTB* building (with many small spaces) are similar to those of geometric paths (see Chapter 7), and a geometric path is not necessary for a user since the user can easily find her/his way along the logical path. However, logical paths at Schiphol Airport consist of several large spaces where users still need detailed paths inside these large spaces. In general, the granularity of subdivision determines the importance of the logical and geometric network for the routing. For cases of large spaces, a solution is to set a maximum size for single spaces, and then subdivide these large spaces until their sizes are lower than/equal to the maximum size (e.g., meshing).

Fourth, two-level routing can be extended to the computation with indoor moving obstacles. Routing in the geometric network derives accessible and obstacle-avoiding paths for a user. When the boundary or location of indoor obstacles (e.g., a crowd of people or moved furniture) changes, one can locate the changed spaces in the logical network. Then at the current moment a new routing can be conducted in the updated geometric network. As only the changed spaces are updated instead of all the spaces,

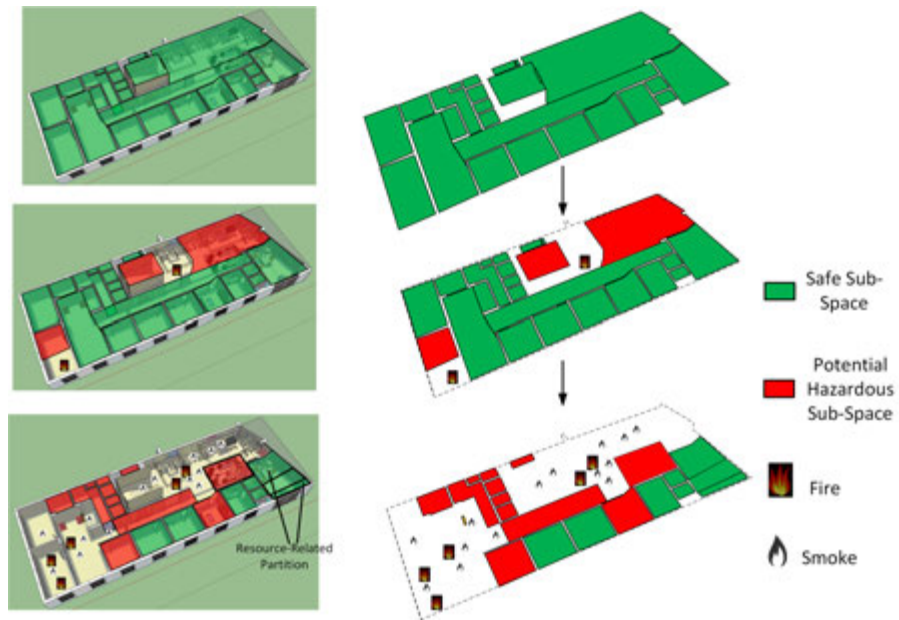

FIGURE 8.3 A series of subdivision caused by changes in a building. The green spaces represent the free spaces, the red ones indicate the potential dangerous areas, and the others represent hazardous regions impacted by smoke and fire.

the two-level routing approach can promptly adjust and then generate paths according to indoor changes. In the case of continuously moving obstacles, it may not be economic to create new networks all the time. Then a possible solution is to introduce time variable and a prediction model of these moving obstacles: 1) in a period of time, to compute the maximum extent of these obstacle movements with the consideration of a safety buffer; 2) to create a navigation network for them during this period; 3) to store this network with time information. In this way, during a certain period a user can request the computed path based on the stored network.

Fifth, though I only applied two-level routing to normal situations of buildings, the approach is extensible for real-time applications such as an emergency response. In such cases, indoor dynamics need to be considered for building subdivision. This thesis adopts the structural subdivision such as provided by the *IFC* and *CityGML* models. However, *INSM* can also support functional subdivisions, which gives flexibility to defining indoor spaces according to the dynamics. Different conceptual and functional spaces can both be taken into account. I present an example to conceptually discuss the dynamic subdivisions of a building. Figure 8.3 illustrates a serial of subdivisions caused by indoor dynamics. At the initial state all the spaces are accessible to a user. Supposing two sites catch fire, then a new subdivision of the building is performed. The spaces near heat sources are denoted in red. As smoke diffuses along with the fire, another subdivision is made to present the limited safe spaces. As Figure 8.3 shows, the green part has shrunk and more and more red spaces imperilled by fire and smoke. In this example all the three subdivisions follow functional constraints. In such cases, log-

ical and geometric networks can be updated on demand based on safe spaces and new obstacles (e.g., waste) generated from the changes.

§ 8.3 Directions for future research

This section will introduce future work to this PhD research. The future work can be categorized into five aspects:

1. To develop more routing options for two-level routing;
2. To extend the two-level routing approach with new topological relationships, new levels, other semantics, dynamic obstacles and emergency scenarios;
3. To link the two-level routing approach to related research such as indoor guidance and building subdivision;
4. To calibrate the two-level routing results and to pinpoint the application scope;
5. To evaluate the feasibility of two-level routing for new scenarios.

More two-level routing options

This thesis proposes seven options for two-level routing (Section 3.4.3). They are devised by an observation of human behaviours and needs in routing. More options can be investigated and designed for other scenarios by collecting questionnaires from users in different types of building. In these new routing options, two-level routing also needs to flexibly compute paths for different users according to their requirements and preferences.

An extension of the two-level approach is multi-level routing. Theoretically arbitrary levels of indoor space hierarchy can be constructed, which depends on building configuration complexity. More complex buildings may contain more levels. The key for such routing problems is the interaction among all the designed levels.

Extension of the two-level routing approach

Two-level routing relies on two types of navigation networks –the logical and the geometric networks. For logical networks, more topological relationships can be considered for indoor routing, such as adjacency of spaces. When two spaces are not connected but adjacent, the fact indicates the two spaces are close. In addition, adjacency reveals some features of a space: if a space involves many adjacency relationships, which indicates it is 'contained' in the building; otherwise, it may be adjacent to outdoors. Thus, the adjacency can be added to new routing criteria on the logical network. For geometric networks, new approaches to give more options can be adopted in more cases. Currently all indoor spaces are represented by 2D polygons. In the future it is necessary to investigate how to apply two-level routing to 3D indoor spaces. For instance, the geometric path should be able to reflect the vertical motion of a human (to get over a chair or get under a desk), or to be able to navigate a drone. In short, two-level routing will be extended by introducing new routing criteria for logical networks,

new creation methods for geometric networks and new routing algorithms for these geometric networks.

Moreover, new levels of details can be introduced to extend two-level routing into multiple-level routing. For instance, an intermediate network representing the connectivity of doors and spaces can be designed in between the logical network and the geometric network, *i.e.*, *opening-to-space* type. As an opening is a kind of 'space', I can put them together with indoor spaces (*NUs*) to construct a navigation network. Such a network directly represents the relationships among *NUs* and openings (mostly doors). In this case, a new routing approach should be developed for the three navigation networks to conduct routing on user demands.

In the two-level routing approach, other semantics in addition to the INSM can be introduced for the logical network and new routing criteria can be developed for these semantics. Semantics of indoor spaces represent different functionalities in distinct data models for specific contexts (*e.g.*, *3DBO* and *IndoorGML*). These semantics can be used to design routing criteria and extend the application scope of two-level routing. For example, a logical network can be assigned with two sets of semantics. Thus, routing on the logical network can be applied to more routing cases.

In addition, two-level routing can be extended to cope with path computation with dynamic (moving and/or unstable-shaped) obstacles. Dynamic obstacles refers to the varying extent of these obstacles, which changes the accessible region of indoor spaces. Thus, routing on both levels needs to follow the real-time boundaries of dynamic obstacles. Spaces heavily influenced by dynamic obstacles should be reflected in the logical network, which results in suitable logical paths for a user; routing in the geometric network generates obstacle-avoiding and accessible paths for the user at a given moment. Two-level routing may need frequent re-computation along with time lapse. Research is needed for synchronization of routing between the two levels with dynamic obstacles. As mentioned before, a simulation model of indoor obstacle dynamics can be introduced. In this case, the varied shape and movement of an obstacle can be predicted along with time lapse. Then a logical and geometric path can be computed at a user's expected time and locations.

Furthermore, applications in emergency scenarios would be investigated, where both more and fewer openings (due to collapse) are possible. In the logical network, the connectivity of spaces would be impacted by emergencies, and then an updating mechanism is required to maintain nodes and edges of the logical network. As the number of dynamic and static obstacles can sharply increase in a short time, geometric networks should be frequently recreated. In this case, the temporal factor can be introduced to computing geometric paths. For example, a logical network and a geometric network are built for the present, and a new logical and a new geometric network are created after five minutes. In this way, emergency and indoor dynamics can be incorporated in the two-level routing approach by updating logical and geometric networks.

Links with other related research

The two-level routing approach is relevant to other related studies on guidance and building subdivision, though this thesis focuses only on the indoor routing component of the indoor navigation process.

Two-level routing can provide input information for indoor guidance for pedestrians. The common method of guidance for pedestrians is textual directions (e.g., 'walk forward 100m, then turn left'). Based on a logical path, an abstract route regarding spaces can be organized in landmark-oriented sentences, such as 'cross Corridor 2, then enter into Office 201'; while for textual directories a geometric path can present more details of the path such as distance and turns. Future research could investigate the combined textual directories generated from the two types of path. For example, only space names are requested by a user due to the simple shapes of the spaces, while both space names and step-by-step instructions are needed for the user in complicated spaces.

Building subdivision can be further studied to support two-level routing. The real-time results of building subdivision can react to two-level routing. A heat map of crowds could be generated when video surveillance is available for a building. On the heat map one can identify hot spots in the building and re-divide new spaces and obstacles (e.g., crowds), which would dynamically derive space subdivision results [ZLS⁺14, KZ14]. These results influence the logical and geometric network in real-time. Further research can be conducted on the dynamic subdivision automation, and the cooperation between the real-time subdivision and two-level routing.

In addition, it would be interesting to investigate the relationships between indoor and outdoor navigation with the two-level routing approach. Outdoor road networks are naturally geometric networks with different modes for distinct agents (vehicles and pedestrians). It is necessary to investigate and categorize semantics of regions in outdoor environments (e.g., blocks), which may facilitate the generation of logical networks for the outdoors. Furthermore, if two-level routing can be applied to the outdoors, researchers need to design user-related routing options where path computation on the two levels should be defined.

Correction of the two-level routing results

Field tests and usability studies should be able to provide an objective evaluation of the results of two-level routing. I can track and monitor user motions and behaviours during indoor routing or wayfinding (without a device), and compare these user tracks with the paths resulting from two-level routing. I can collect the statistics regarding the fitness of the computed paths and the actual user tracks.

Indoor tracking on pedestrians can provide feedback about the practice of users following the computed path. The real trace of users can be used to improve two-level routing. Indoor tracking can be supported by video surveillance [ZZW⁺16] or indoor positioning equipment. User traces can be extracted from videos [ZZW⁺16]. Indoor positioning techniques can also continuously collect user locations and support extracting user traces [Xu14]. The processed traces are field data which help the correction of computed logical and geometric paths. The spaces traversed by a user can be compared with the computed logical path, and the trace of the user can be matched to geometric networks to highlight the differences with the computed geometric path. In addition, a real-time indoor tracking system can help users better interact with the two-level routing system to follow the resulting paths. For example, a user is walking along the computed geometric path but she/he meets some difficulties to distinguish the next step. Thus, the user decides to re-plan her/his route by sending the current location to the two-level routing system.

The two-level routing results can be calibrated and the criteria can be improved according to the indoor tracking results. For example, one can collect statistics on the adopted paths of users in a building. Frequently used paths reflect certain user demands and can be compared with the computed ones for the user. Further studies should focus on what factors derive such differences, and then adopt these factors to update the routing criteria.

Another possible study is to pinpoint the application scope of two-level routing. Research could be developed to investigate the complexity of buildings and apply two-level routing to them. For all the buildings, researchers can compute paths by applying two-level routing and then monitor the computed paths that users would like to follow in each building. If only a few users would like to follow the paths in the buildings with certain complexity, this can indicate that two-level routing may not be suitable for such buildings. In this case, routing results would be analysed to conclude whether two-level routing is appropriate to which level of building complexity.

Evaluate the feasibility of two-level routing for new scenarios

Researchers may further extend the two-level routing approach to more applications. Two-level routing derives geometric paths on the basis of a visibility graph. Mortari *et al.* (2014) provide a comparison of the visibility-based networks with centreline-based networks such as Medial Axis Transformation (MAT) [MZLC14]. The centreline-based navigation networks fit for narrow corridor cases, and the visibility-based (*e.g.*, two-level routing) ones are suitable for larger and open spaces. The future work needs to evaluate whether two-level routing is suitable for other new types of application scenario (*e.g.*, with moving obstacles). Some factors can be introduced for tests in these new scenarios, such as the cost of time and compatibility with indoor positioning results.

Other promising directions include:

1. Authentic 3D routing. For example, two-level routing can be performed for flying drones which move in complete 3D environments (*e.g.*, above and on surfaces). In such cases, a 3D indoor environment needs to be subdivided according to certain purposes (*e.g.*, the size of a drone and/or importance of the space). Then routing on the abstract level could compute logical paths in the light of certain criteria (*e.g.*, to minimize the total volume of selected spaces). Consequently, the geometric path can be computed, based on the logical path.
2. Two-level routing which considers 'optimal' paths (*e.g.*, the fastest or shortest paths). On the abstract level, one can investigate how to compute a logical path which contains the 'optimal' geometric path. In other words, indoor spaces for routing can be reduced and the optimality of the geometric path can be ensured as well.
3. The INSM model can be used to analyse other building scenarios for routing in existing buildings. As addressed before, the INSM is designed to distinguish the use of indoor semantics and this facilitates the generation of navigation networks of two-level routing. Different existing buildings can be enriched with the INSM semantics and then two-level routing can be applied to them.
4. Real-time factors such as crowd flows and path capacity can be incorporated into two-level routing, which would facilitate evacuation planning in different buildings. For instance, crowd flows can be regarded as dynamic obstacles which vary over time. Crowd

behaviour should be taken into account to estimate and simulate crowd flow. In different time slots, two-level routing can be employed to compute accessible paths in real-time. In addition, path capacity (*i.e.*, the number of people that can pass through a space) can be evaluated for each space, and new routing criteria could be proposed with regard to the path capacity.

Bibliography

- [AEF⁺95] N. Akkiraju, H. Edelsbrunner, M. Facello, P. Fu, E.P. Mcke, and C. Varela. Alpha shapes: Definition and software. In *Proceedings of the 1st International Computational Geometry Software Workshop*, pages 63–66, 1995.
- [Age09] U.S. Environmental Protection Agency. Buildings and their impact on the environment: A statistical summary, 2009. Online <https://archive.epa.gov/greenbuilding/web/pdf/gbstats.pdf>.
- [Ams15] AmsterdamTourist.info. Airport schiphol, 2015. Online <http://www.amsterdamtourist.info/about-amsterdam/transportation/amsterdam-airport-schiphol/>.
- [AS09] A.K. Andreas and J.C. Smith. Decomposition algorithms for the design of a nonsimultaneous capacitated evacuation tree network. *Networks*, 53(2):91–103, 2009.
- [AVF04] C. Andújar, P. Vázquez, and M. Fairén. Way-finder: guided tours through complex walkthrough models. In *Computer Graphics Forum*, volume 23, pages 499–508. Wiley Online Library, 2004.
- [AW88] H. Alt and E. Welzl. Visibility graphs and obstacle-avoiding shortest paths. *Zeitschrift für Operations Research*, 32(3-4):145–164, 1988.
- [BAHS93] D.L. Butler, A.L. Acquino, A.A. Hissong, and P.A. Scott. Wayfinding by newcomers in a complex building. *Human factors: The Journal of the Human Factors and Ergonomics Society*, 35(1):159–173, 1993.
- [BCC06] G. Brusa, M.L. Caliusco, and O. Chiotti. A process for building a domain ontology: an experience in developing a government budgetary ontology. In *Proceedings of the second Australasian workshop on Advances in ontologies-Volume 72*, pages 7–15. Australian Computer Society, Inc., 2006.
- [BD05] C. Becker and F. Dürr. On location models for ubiquitous computing. *Personal Ubiquitous Computing*, 9(1):20–31, January 2005. doi=<http://dx.doi.org/10.1007/s00779-004-0270-2>.
- [Bel58] R. Bellman. On a routing problem. *Quarterly of applied mathematics*, pages 87–90, 1958.
- [BFH97] W. Burgard, D. Fox, and D. Hennig. Fast grid-based position tracking for mobile robots. In *Annual Conference on Artificial Intelligence*, pages 289–300. Springer, 1997.
- [BG10] P. Boguslawski and C. Gold. Euler operators and navigation of multi-shell building models. In *Developments in 3D geo-information sciences*, pages 1–16. Springer, 2010.
- [BGL11] P. Boguslawski, C.M. Gold, and H. Ledoux. Modelling and analysing 3D buildings with a primal/dual data structure. *ISPRS Journal of Photogrammetry and Remote Sensing*, 66(2):188–197, 2011.
- [Blu05] C. Blum. Ant colony optimization: Introduction and recent trends. *Physics of Life reviews*, 2(4):353–373, 2005.
- [BM04] J.E. Bell and P.R. McMullen. Ant colony optimization techniques for the vehicle routing problem. *Advanced Engineering Informatics*, 18(1):41–48, 2004.
- [BMZF16] P. Boguslawski, L. Mahdjoubi, V. Zverovich, and F. Fadli. Automated construction of variable density navigable networks in a 3D indoor environment for emergency response. *Automation in Construction*, 72, Part 2:115 – 128, 2016.
- [BNK09] T. Becker, C. Nagel, and T.H. Kolbe. A multilayered space-event model for navigation in indoor spaces. In J. Lee and S. Zlatanova, editors, *3D Geo-Information Sciences*, Lecture Notes in Geoinformation and Cartography, pages 61–77. Springer Berlin Heidelberg, 2009.
- [BNZK13] G. Brown, C. Nagel, S. Zlatanova, and T.H. Kolbe. Modelling 3D topographic space against

indoor navigation requirements. In *Progress and New Trends in 3D Geoinformation Sciences*, pages 1–22. Springer, 2013.

- [Bra01] U. Brandes. A faster algorithm for betweenness centrality. *Journal of Mathematical Sociology*, 25(2):163–177, 2001.
- [BS01] Brumitt B. and Shafer S. Topological world modeling using semantic spaces. In *Proceedings of the Workshop on Location Modeling for Ubiquitous Computing*, page 55–62, September 2001.
- [BT98] S. Bandi and D. Thalmann. Space discretization for efficient human navigation. In *Computer Graphics Forum*, volume 17, pages 195–206. Wiley Online Library, 1998.
- [BV13] P. Boldi and S. Vigna. Axioms for centrality. *Internet Mathematics*, 10:222–262, 2013.
- [CD85] B. Chazelle and D.P. Dobkin. Optimal convex decompositions. *Machine Intelligence & Pattern Recognition*, 2(5):63–133, 1985.
- [CDO08] M. Caramia and P. Dell’Olmo. Multi-objective optimization. *Multi-objective Management in Freight Logistics: Increasing Capacity, Service Level and Safety with Optimization Algorithms*, pages 11–36, 2008.
- [CL09] J. Choi and J. Lee. 3D geo-network for agent-based building evacuation simulation. In *3D geo-information sciences*, pages 283–299. Springer, 2009.
- [CNPM11] Fuchs C., Aschenbruck N., Martini P., and Wieneke M. Indoor tracking for mission critical scenarios: A survey. *Pervasive and Mobile Computing*, 7(1):1–15, 2011.
- [Coe12] S.A.M. Coenen. Motion planning for mobile robots - a guide. Master’s thesis, Mechanical Engineering, Eindhoven University of Technology, Eindhoven, 2012.
- [Con16] SQLite Consortium. About sqlite, 2016. Online <http://sqlite.org/about.html>.
- [CTG⁺06] Hölscher C., Meilinger T., Vrachliotis G., Brösamle M., and Knauff M. Up the down staircase: Wayfinding strategies in multi-level buildings. *Journal of Environmental Psychology*, 26(4):284–299, 2006.
- [CWSC14] L.C. Chen, C.H. Wu, T.S. Shen, and C.C. Chou. The application of geometric network models and building information models in geospatial environments for fire-fighting simulations. *Computers, Environment and Urban Systems*, 45(0):1–12, 2014.
- [dBCvKO08] M. de Berg, O. Cheong, M. van Kreveld, and M.H. Overmars. *Computational Geometry: Algorithms and Applications*. Springer-Verlag TELOS, Santa Clara, CA, USA, 3rd ed. edition, 2008.
- [Deb14] K. Deb. Multi-objective optimization. In E.K. Burke and G. Kendall, editors, *Search Methodologies*, pages 403–449. Springer US, 2014. http://dx.doi.org/10.1007/978-1-4614-6940-7_15.
- [DGK09a] P.M. Dudas, M. Ghafourian, and H.A. Karimi. ONALIN: Ontology and algorithm for indoor routing. In *2009 Tenth International Conference on Mobile Data Management: Systems, Services and Middleware*, pages 720–725. IEEE, 2009.
- [DGK09b] P.M. Dudas, M. Ghafourian, and H.A. Karimi. Onalin: Ontology and algorithm for indoor routing. In *Mobile Data Management: Systems, Services and Middleware, 2009. MDM ’09. Tenth International Conference on*, pages 720–725, May 2009.
- [Die10] R. Diestel. *Graph Theory*. Springer-Verlag Berlin Heidelberg, 4th edition, 2010.
- [Dij59] E.W. Dijkstra. A note on two problems in connexion with graphs. *Numerische Mathematik*, 1(1):269–271, 1959.
- [DL08] Li D. and D.L. Lee. A lattice-based semantic location model for indoor navigation. In *2008 the 9th International Conference on Mobile Data Management*, pages 17–24, April 2008.

- [DMVOFH⁺15] B. Dominguez-Martin, P. van Oosterom, F. Feito-Higueruela, A.L. Garcia-Fernandez, and C.J. Ogayar-Anguita. Automatic generation of medium-detailed 3D models of buildings based on cad data (abstract). In *CGI'15, 32nd annual Conference, Strasbourg*, page 2, June 2015.
- [DZ16] A.A. Diakité and S. Zlatanova. Extraction of the 3D free space from building models for indoor navigation. *ISPRS Annals of Photogrammetry, Remote Sensing and Spatial Information Sciences*, IV-2/W1:241–248, 2016.
- [EE99] D. Eppstein and J. Erickson. Raising roofs, crashing cycles, and playing pool: Applications of a data structure for finding pairwise interactions. *Discrete & Computational Geometry*, 22(4):569–592, 1999.
- [EM94] H. Edelsbrunner and E.P. Mücke. Three-dimensional alpha shapes. *ACM Trans. Graph.*, 13(1):43–72, January 1994.
- [Fic16] F.W. Fichtner. Semantic enrichment of a point cloud based on an octree for multi-storey pathfinding. Master's thesis, Urbanism Department, Faculty of Architecture and The Built Environment, Delft University of Technology, Netherlands, 2016.
- [FJ56] L.R. Ford Jr. Network flow theory. Technical report, DTIC Document, 1956.
- [FLZS12] Z. Fang, Q. Li, X. Zhang, and S. Shaw. A GIS data model for landmark-based pedestrian navigation. *International Journal of Geographical Information Science*, 26(5):817–838, 2012.
- [FMB00] C. Freksa, R. Moratz, and T. Barkowsky. Schematic maps for robot navigation. In C. Freksa, C. Habel, W. Brauer, and K.F. Wender, editors, *Spatial Cognition II*, volume 1849 of *Lecture Notes in Computer Science*, pages 100–114. Springer Berlin Heidelberg, 2000.
- [FMWN05] G. Franz, H. Mallot, J. Wiener, and K. Neurowissenschaft. Graph-based models of space in architecture and cognitive science—a comparative analysis. In *Proceedings of the 17th International Conference on Systems Research, Informatics and Cybernetics*, volume 3038, 2005.
- [FZL⁺11] Z. Fang, X. Zong, Q. Li, Q. Li, and S. Xiong. Hierarchical multi-objective evacuation routing in stadium using ant colony optimization approach. *Journal of Transport Geography*, 19(3):443–451, 2011.
- [G.66] Sabidussi G. The centrality index of a graph. *Psychometrika*, 31(4):581–603, 1966.
- [GBK14] R. Goldstein, S. Breslav, and A. Khan. Towards voxel-based algorithms for building performance simulation. In *Proceedings of the IBPSA-Canada eSim Conference*, 2014.
- [GCZ⁺11] G. Girard, S. Côté, S. Zlatanova, Y. Barette, J. St-Pierre, and P. Van Oosterom. Indoor pedestrian navigation using foot-mounted IMU and portable ultrasound range sensors. *Sensors*, 11(8):7606–7624, 2011.
- [GKNH12] G. Gröger, T.H. Kolbe, C. Nagel, and K.H. Häfele. OGC City Geography Markup Language (CityGML) Encoding Standard, 2012.
- [GO07] R. Geraerts and M.H. Overmars. The corridor map method: a general framework for real-time high-quality path planning. *Computer Animation and Virtual Worlds*, 18(2):107–119, 2007.
- [GSC⁺05] C. Galindo, A. Saffiotti, S. Coradeschi, P. Buschka, J.A. Fernandez-Madriral, and J. Gonzalez. Multi-hierarchical semantic maps for mobile robotics. In *Intelligent Robots and Systems, 2005. (IROS 2005). 2005 IEEE/RSJ International Conference on*, pages 2278–2283, Aug 2005.
- [GZ11a] M. Goetz and A. Zipf. *Extending OpenStreetMap to indoor environments*, pages 51–61. CRC Press, 2011. doi:10.1201/b11647-7.
- [GZ11b] M. Goetz and A. Zipf. Formal definition of a user-adaptive and length-optimal routing graph for complex indoor environments. *Geo-spatial Information Science*, 14(2):119–128, 2011.
- [GZ13] M. Goetz and A. Zipf. Indoor route planning with volunteered geographic information on a (mobile) web-based platform. In J.M. Krisp, editor, *Progress in Location-Based Services*, Lecture Notes in Geoinformation and Cartography, pages 211–231. Springer Berlin Heidelberg, 2013.

- [Har12] B.M. Harvey. Perform + function: A proposal for a healthy public housing community. Master's thesis, 2012.
- [HB07] C. Hölscher and M. Brösamle. Capturing indoor wayfinding strategies and differences in spatial knowledge with space syntax. In *Proceedings, 6th International Space Syntax Symposium, Istanbul*, 2007.
- [HB15] S.C. Hirtle and C.R. Bahm. *Cognition for the Navigation of Complex Indoor Environments*, pages 1–12. CRC Press, 2015. doi:10.1201/b18220-2.
- [HBK⁺10] M. Höcker, V. Berkahn, A. Kneidl, A. Borrmann, and W. Klein. Graph-based approaches for simulating pedestrian dynamics in building models. *eWork and eBusiness in Architecture, Engineering and Construction*, pages 389–394, 2010.
- [HD04] Hu H. and Lee D.L. Semantic location modeling for location navigation in mobile environment. In *Proceedings of 2004 IEEE International Conference on Mobile Data Management*, pages 52–61, 2004.
- [Hel13] T. Helms. A voxel-based platform for game development. 2013.
- [HEZ12] I.H. Hijazi, M. Ehlers, and S. Zlatanova. NIBU: a new approach to representing and analysing interior utility networks within 3D geo-information systems. *International Journal of Digital Earth*, 5(1):22–42, 2012.
- [HGL⁺09] H. Hile, R. Grzeszczuk, A. Liu, R. Vedantham, J. Košćeka, and G. Borriello. Landmark-based pedestrian navigation with enhanced spatial reasoning. In *International Conference on Pervasive Computing*, pages 59–76. Springer, 2009.
- [HLLK02] C.S. Han, K.H. Law, J.C. Latombe, and J.C. Kunz. A performance-based approach to wheelchair accessible route analysis. *Advanced Engineering Informatics*, 16(1):53 – 71, 2002.
- [HNR68] P.E. Hart, N.J. Nilsson, and B. Raphael. A formal basis for the heuristic determination of minimum cost paths. *IEEE transactions on Systems Science and Cybernetics*, 4(2):100–107, 1968.
- [HOP⁺08] Zender H., Martínez Mozos O., Jensfelt P., Kruijff G.-J.M., and Burgard W. Conceptual spatial representations for indoor mobile robots. *Robotics and Autonomous Systems*, 56(6):493 – 502, 2008. From Sensors to Human Spatial Concepts.
- [HP10] A.M. Hund and A.J. Padgitt. Direction giving and following in the service of wayfinding in a complex indoor environment. *Journal of Environmental Psychology*, 30(4):553–564, 2010.
- [HSB⁺05] D. Heckmann, T. Schwartz, B. Brandherm, M. Schmitz, and M. von Wilamowitz-Moellendorff. GUMO—the general user model ontology. In L. Ardissono, P. Brna, and A. Mitrovic, editors, *User Modeling 2005*, volume 3538 of *Lecture Notes in Computer Science*, pages 428–432. Springer Berlin Heidelberg, 2005.
- [HYA12] M.L. Hidayetoglu, K. Yildirim, and A. Akalin. The effects of color and light on indoor wayfinding and the evaluation of the perceived environment. *Journal of Environmental Psychology*, 32(1):50–58, 2012.
- [IAI16] IAI. IFC overview summary, 2016. Online <http://www.buildingsmart-tech.org/specifications/ifc-overview>.
- [ICC12] Afyouni I., Ray C., and Claramunt C. Spatial models for context-aware indoor navigation systems: A survey. *J. Spatial Information Science*, 4(1):85–123, 2012.
- [ict16] The igraph core team. igraph, 2016. Online <http://igraph.org>.
- [Inc17] Microsoft Inc. Visual studio downloads, 2017. online <https://www.visualstudio.com/downloads/>.
- [Ind16] IndoorAtlas. Indooratlas platform, 2016. Online: <https://www.indooratlas.com/>.
- [IZ09] U. Isikdag and S. Zlatanova. Towards defining a framework for automatic generation of build-

ings in CityGML using building information models. In *3D Geo-Information Sciences*, pages 79–96. Springer, 2009.

- [JLY09] C.S. Jensen, H. Lu, and B. Yang. Graph model based indoor tracking. In *2009 Tenth International Conference on Mobile Data Management: Systems, Services and Middleware*, pages 122–131. IEEE, 2009.
- [JM05] Lee J., and Kwan M. A combinatorial data model for representing topological relations among 3D geographical features in microspatial environments. *International Journal of Geographical Information Science*, 19(10):1039–1056, 2005. doi=<http://dx.doi.org/10.1080/13658810500399043>.
- [JS02] C. Jiang and P. Steenkiste. A hybrid location model with a computable location identifier for ubiquitous computing. In G. Borriello and L. Holmquist, editors, *UbiComp 2002: Ubiquitous Computing*, volume 2498 of *Lecture Notes in Computer Science*, pages 246–263. Springer Berlin Heidelberg, 2002. doi=http://dx.doi.org/10.1007/3-540-45809-3_20.
- [JT10] D. Jones and M. Tamiz. *Practical goal programming*, volume 141. Springer, 2010.
- [JTY11] Thill J., Dao T.H.D., and Zhou Y. Traveling in the three-dimensional city: applications in route planning, accessibility assessment, location analysis and beyond. *Journal of Transport Geography*, 19(3):405 – 421, 2011. Special Issue: Geographic Information Systems for Transportation.
- [KBH12] A. Kneidl, A. Borrmann, and D. Hartmann. Generation and use of sparse navigation graphs for microscopic pedestrian simulation models. *Advanced Engineering Informatics*, 26(4):669 – 680, 2012.
- [KG10] H.A. Karimi and M. Ghafourian. Indoor routing for individuals with special needs and preferences. *Transactions in GIS*, 14(3):299–329, 2010.
- [KGO10] I. Karamouzas, R. Geraerts, and M.H. Overmars. Indicative routes for path planning and crowd simulation. In *Proceedings of the 4th International Conference on Foundations of Digital Games*, pages 113–120. ACM, 2010.
- [KGP05] T.H. Kolbe, G. Gröger, and L. Plümer. CityGML: Interoperable access to 3D city models. In *Geoinformation for disaster management*, pages 883–899. Springer, 2005.
- [KJ98] J.J. Kuffner Jr. Goal-directed navigation for animated characters using real-time path planning and control. In *Modelling and Motion Capture Techniques for Virtual Environments*, pages 171–186. Springer, 1998.
- [KK12] A.A. Khan and T.H. Kolbe. Constraints and their role in subsampling for the locomotion types in indoor navigation. In *Indoor Positioning and Indoor Navigation (IPIN)*, page 12, Nov 2012.
- [KKRA08] M. Khider, S. Kaiser, P. Robertson, and M. Angermann. The effect of maps-enhanced novel movement models on pedestrian navigation performance. In *Proceedings of The 12th annual European Navigation Conference (ENC 2008), Toulouse, France*, volume 2228, 2008.
- [KS15] N. Kostic and S. Scheider. Automated generation of indoor accessibility information for mobility-impaired individuals. In F. Bacao, M.Y. Santos, and M. Painho, editors, *AGILE 2015, Lecture Notes in Geoinformation and Cartography*, pages 235–252. Springer International Publishing, 2015.
- [KT03] Y. Kato and Y. Takeuchi. Individual differences in wayfinding strategies. *Journal of Environmental Psychology*, 23(2):171–188, 2003.
- [KZ14] M. Krüminaitė and S. Zlatanova. Indoor space subdivision for indoor navigation. In *Proceedings of the Sixth ACM SIGSPATIAL International Workshop on Indoor Spatial Awareness*, pages 25–31. ACM, 2014.
- [Lat91] J. Latombe. *Robot Motion Planning*. Kluwer Academic Publishers, Norwell, MA, USA, 1991.
- [LCR10] X. Li, C. Claramunt, and C. Ray. A grid graph-based model for the analysis of 2D indoor spaces. *Computers, Environment and Urban Systems*, 34(6):532 – 540, 2010. GeoVisualization and

the Digital CitySpecial issue of the International Cartographic Association Commission on Geo-Visualization.

- [LD04] F. Lamarche and S. Donikian. Crowd of virtual humans: a new approach for real time navigation in complex and structured environments. *Computer Graphics Forum*, 23(3):509–518, 2004.
- [Lee61] C.Y. Lee. An algorithm for path connections and its applications. *IRE transactions on electronic computers*, (3):346–365, 1961.
- [Lee01] J. Lee. *A 3D Data Model for Representing Topological Relationships Between Spatial Entities in Built-Environments*. PhD thesis, The Ohio State University, 2001.
- [Lee04] J. Lee. A spatial access-oriented implementation of a 3-D GIS topological data model for urban entities. *GeoInformatica*, 8(3):237–264, 2004.
- [LH08] Y. Li and Z. He. 3D indoor navigation: a framework of combining BIM with 3D GIS. In *2008 the 44th ISOCARP Congress*, 2008.
- [LP82] M. Levine, I.N. Jankovic, and M. Palij. Principles of spatial problem solving. *Journal of Experimental Psychology: General*, 111(2):157, 1982.
- [LL08] D. Li and D. Lee. A topology-based semantic location model for indoor applications. In *Proceedings of the 16th ACM SIGSPATIAL International Conference on Advances in Geographic Information Systems, GIS '08*, pages 6:1–6:10, New York, NY, USA, 2008. ACM. doi=<http://doi.acm.org/10.1145/1463434.1463443>.
- [LLC16] Quuppa LLC. Quuppa intelligent locating system, 2016. Online <http://quuppa.com/>.
- [LLHY08] P. Lin, S.M. Lo, H.C. Huang, and K.K. Yuen. On the use of multi-stage time-varying quickest time approach for optimization of evacuation planning. *Fire Safety Journal*, 43(4):282–290, 2008.
- [LLZ⁺14] J. Lee, K.J. Li, S. Zlatanova, T.H. Kolbe, C. Nagel, and T. Becker. IndoorGML, 2014.
- [LOS06a] B. Lorenz, H.J. Ohlbach, and E.P. Stoffel. A hybrid spatial model for representing indoor environments. In J.D. Carswell and T. Tezuka, editors, *Web and Wireless Geographical Information Systems*, volume 4295 of *Lecture Notes in Computer Science*, pages 102–112. Springer Berlin Heidelberg, 2006.
- [LOS06b] B. Lorenz, H.J. Ohlbach, and E.P. Stoffel. A hybrid spatial model for representing indoor environments. In J.D. Carswell and T. Tezuka, editors, *Web and Wireless Geographical Information Systems*, volume 4295 of *Lecture Notes in Computer Science*, pages 102–112. Springer Berlin Heidelberg, 2006. doi=http://dx.doi.org/10.1007/11935148_10.
- [LSA08] F. Lyardet, D.W. Szeto, and E. Aitenbichler. Context-aware indoor navigation. In *European Conference on Ambient Intelligence*, pages 290–307. Springer, 2008.
- [LXPZ15] L. Liu, W. Xu, W. Penard, and S. Zlatanova. Leveraging spatial model to improve indoor tracking. *The International Archives of the Photogrammetry, Remote Sensing and Spatial Information Sciences*, XL-4/W5(4):75–80, 2015.
- [LYJS09] J. Lertlakkhanakul, Li Y., Choi J., and Bu S. Gongpath: Development of BIM based indoor pedestrian navigation system. In *INC, IMS and IDC, 2009. NCM '09. Fifth International Joint Conference on*, pages 382–388, Aug 2009.
- [LZ11a] L. Liu and S. Zlatanova. A “door-to-door” path-finding approach for indoor navigation. In *Proceedings of GeoInformation For Disaster Management Conference 2011*, pages 3–8, 2011.
- [LZ11b] L. Liu and S. Zlatanova. *Towards a 3D network model for indoor navigation*, pages 79–94. CRC Press, 2011. doi:10.1201/b11647-9.
- [LZ12] L. Liu and S. Zlatanova. A semantic data model for indoor navigation. In *Proceedings of the Fourth ACM SIGSPATIAL International Workshop on Indoor Spatial Awareness, ISA '12*, pages 1–8, New York, NY, USA, 2012. ACM.

- [LZ13a] L. Liu and S. Zlatanova. Generating navigation models from existing building data. *The International Archives of the Photogrammetry, Remote Sensing and Spatial Information Sciences*, XL-4/W4(4):19–25, 2013.
- [LZ13b] L. Liu and S. Zlatanova. A two-level path-finding strategy for indoor navigation. In S. Zlatanova, R. Peters, A. Dilo, and H. Scholten, editors, *Intelligent Systems for Crisis Management*, Lecture Notes in Geoinformation and Cartography, pages 31–42. Springer Berlin Heidelberg, 2013.
- [LZ15] L. Liu and S. Zlatanova. An approach for indoor path computation among obstacles that considers user dimension. *ISPRS International Journal of Geo-Information*, 4(4):2821–2841, 2015.
- [LZLF08] M. Lu, J.F. Zhang, P. Lv, and Z.H. Fan. Least visible path analysis in raster terrain. *International Journal of Geographical Information Science*, 22(6):645–656, 2008.
- [Mau12] R. Mautz. *Indoor positioning technologies*. Südwestdeutscher Verlag Für Hochschulschriften AG, 2012.
- [ME85] H. Moravec and A. Elfes. High resolution maps from wide angle sonar. In *Robotics and Automation. Proceedings. 1985 IEEE International Conference on*, volume 2, pages 116–121. IEEE, 1985.
- [Mil06] L.E. Miller. *Indoor Navigation for First Responders: A Feasibility Study*, volume 77. 2006.
- [MJ05] Kwan M. and Lee J. Emergency response after 9/11: the potential of real-time 3D GIS for quick emergency response in micro-spatial environments. *Computers, Environment and Urban Systems*, 29(2):93 – 113, 2005.
- [MS07] A. Millonig and K. Schechtner. Developing landmark-based pedestrian-navigation systems. *IEEE Transactions on Intelligent Transportation Systems*, 8(1):43–49, 2007.
- [Mun84a] J.R. Munkres. *Elements of algebraic topology*. 1984.
- [Mun84b] J.R. Munkres. *Elements of Algebraic Topology*. Advanced book classics. Addison-Wesley, 1984.
- [MZLC14] F. Mortari, S. Zlatanova, L. Liu, and E. Clementini. “Improved Geometric Network Model” (IGNM): a novel approach for deriving connectivity graphs for indoor navigation. *ISPRS Annals of the Photogrammetry, Remote Sensing and Spatial Information Sciences*, 2(4):45, 2014.
- [MZP05] M. Meijers, S Zlatanova, and N. Pfeifer. 3D geo-information indoors: structuring for evacuation. In *Proceedings of Next generation 3D city models*, 2005.
- [MZV15] A. Makri, S. Zlatanova, and E. Verbree. An approach for indoor wayfinding replicating main principles of an outdoor navigation system for cyclists. In *The International Archives of the Photogrammetry, Remote Sensing and Spatial Information Sciences, Indoor-Outdoor Seamless Modelling, Mapping and Navigation, Tokyo (japan), 21-22 May, 2015*. International Society of Photogrammetry and Remote Sensing (ISPRS, 2015).
- [ND11] S. Nadi and M.R. Delavar. Multi-criteria, personalized route planning using quantifier-guided ordered weighted averaging operators. *International Journal of Applied Earth Observation and Geoinformation*, 13(3):322–335, 2011.
- [NM01] N.F. Noy and D.L. McGuinness. *Ontology development 101: A guide to creating your first ontology*, 2001. Stanford knowledge systems laboratory technical report KSL-01-05 and Stanford medical informatics technical report SMI-2001-0880, Stanford, CA.
- [NSK09] C. Nagel, A. Stadler, and T.H. Kolbe. Conceptual requirements for the automatic reconstruction of building information models from uninterpreted 3D models. *Proceedings of the International Archives of Photogrammetry, Remote Sensing and Spatial Information Sciences*, pages 46–53, 2009.
- [OGC11] Inc. Open Geospatial Consortium. *OpenGIS Implementation Standard for Geographic information - Simple feature access*. 1.2.1 edition, 2011.
- [OMP09] R. Otmani, A. Moussaoui, and A. Pruski. A new approach to indoor accessibility. *International*

Journal of Smart Home, 3(4):1 – 14, 2009.

- [OW88] M.H. Overmars and E. Welzl. New methods for computing visibility graphs. In *Proceedings of the Fourth Annual Symposium on Computational Geometry*, SCG '88, pages 164–171, New York, NY, USA, 1988. ACM.
- [PCD⁺07] C. Portele, S.J.D. Cox, P. Daisey, R. Lake, and A. Whiteside. OpenGIS geography markup language (gml) encoding standard version 3.2.1. 07-036, 2007.
- [PH12] A.J. Padgitt and A.M. Hund. How good are these directions? determining direction quality and wayfinding efficiency. *Journal of Environmental Psychology*, 32(2):164–172, 2012.
- [Pru10] A. Pruski. A unified approach to accessibility for a person in a wheelchair. *Robot. Auton. Syst.*, 58(11):1177–1184, November 2010.
- [PZ05] S. Pu and S. Zlatanova. Evacuation route calculation of inner buildings. In P. van Oosterom, S. Zlatanova, and E.M. Fendel, editors, *Geo-information for Disaster Management*, pages 1143–1161. Springer Berlin Heidelberg, 2005.
- [R.10] Geraerts R. Planning short paths with clearance using explicit corridors. In *IEEE International Conference on Robotics and Automation*, pages 1997–2004, 2010.
- [Rab00] S. Rabin. *A* Aesthetic Optimizations*, pages 264–271. Charles River Media, 2000.
- [RGL⁺07] K. Rehrl, N. Göll, S. Leitinger, S. Brunsch, and H. Mentz. Smartphone-based information and navigation aids for public transport travellers. In G. Gartner, W. Cartwright, and M.P. Peterson, editors, *Location Based Services and TeleCartography*, Lecture Notes in Geoinformation and Cartography, pages 525–544. Springer Berlin Heidelberg, 2007.
- [RKL15] H.G. Ryoo, T. Kim, and K.J. Li. Comparison between two OGC standards for indoor space: CityGML and IndoorGML. In *Proceedings of the Seventh ACM SIGSPATIAL International Workshop on Indoor Spatial Awareness*, ISA '15, pages 1:1–1:8, New York, NY, USA, 2015. ACM.
- [Rüe07] U.J. Rüetschi. *Wayfinding in Scene Space Modelling Transfers in Public Transport*. PhD thesis, University of Zurich, Zurich, 2007.
- [RVZ16] O.B.P.M. Rodenberg, E. Verbree, and S. Zlatanova. Indoor A* pathfinding through an octree representation of a point cloud. *ISPRS Annals of Photogrammetry, Remote Sensing and Spatial Information Sciences*, IV-2/W1:249–255, 2016. doi=10.5194/isprs-annals-IV-2-W1-249-2016.
- [RW02] M. Raubal and S. Winter. Enriching wayfinding instructions with local landmarks. In *International Conference on Geographic Information Science*, pages 243–259. Springer, 2002.
- [RW14] K.F. Richter and S. Winter. *Landmarks: GIScience for intelligent services*. Springer Science & Business, 2014.
- [RWS11] K. F. Richter, S. Winter, and S. Santosa. Hierarchical representations of indoor spaces. *Environment and Planning B: Planning and Design*, 38(6):1052–1070, 2011.
- [RZC14] D. Russo, S. Zlatanova, and E. Clementini. Route directions generation using visible landmarks. In *Proceedings of the Sixth ACM SIGSPATIAL International Workshop on Indoor Spatial Awareness*, ISA '14, pages 1–8, New York, NY, USA, 2014. ACM.
- [S.05] Borgatti S. Centrality and network flow. *Social Networks*, 27(1):55 – 71, 2005.
- [SAKM⁺07] D.C. Stevens, M. Akram Khan, D.P. Munson, E. J. Reid, C.C. Helseth, and J. Buggy. The impact of architectural design upon the environmental sound and light exposure of neonates who require intensive care: an evaluation of the boekelheide neonatal intensive care nursery. *Journal of Perinatology*, 27:20–28, 2007.
- [Sch10] J. Schaap. Towards a 3D geo-data model to support pedestrian routing in multimodal public transport travel advices. Master's thesis, Faculty of Geo-Information Science and Earth Observation (ITC), University of Twente, 2010.

- [Sec16] OCCS Development Committee Secretariat. Omniclass construction classification system, 2016. Online <http://www.omniclass.org/>.
- [Sed02] R. Sedgewick. Algorithms in C++, part 5: Graph Algorithms-3/E. 2002.
- [SGS12] K.R. Schougaard, K. Grønbaek, and T. Scharling. Indoor pedestrian navigation based on hybrid route planning and location modeling. In *International Conference on Pervasive Computing*, pages 289–306. Springer, 2012.
- [SK07] B.J. Stankiewicz and A.A. Kalia. Acquisition of structural versus object landmark knowledge. *Journal of Experimental Psychology: Human Perception and Performance*, 33(2):378, 2007.
- [SKO97] M. Soeda, N. Kushiyama, and R. Ohno. Wayfinding in cases with vertical motion. In *MERA97: Proceedings of International Conference on Environment-Behavior Studies for the 21st Century*, pages 559–564, 1997.
- [Sli06] A. Slingsby. *Digital Mapping in Three Dimensional Space: Geometry, Features and Access (unpublished)*. PhD thesis, Centre for Advanced Spatial Analysis, University College London, 2006.
- [SLO07] E.P. Stoffel, B. Lorenz, and H.J. Ohlbach. Towards a semantic spatial model for pedestrian indoor navigation. In *Proceedings of the 2007 Conference on Advances in Conceptual Modeling: Foundations and Applications*, ER'07, pages 328–337, Berlin, Heidelberg, 2007. Springer-Verlag. doi=<http://dl.acm.org/citation.cfm?id=1784542.1784596>.
- [Sol16] LA Solutions. Ec schema data, 2016. Online <http://www.la-solutions.co.uk/content/Databases/Databases.htm#ECSchema>.
- [Spa07] I. Spasso. *Algorithms for map-aided autonomous indoor pedestrian positioning and navigation*. PhD thesis, Swiss Federal Institute of Technology in Lausanne, Switzerland, 2007.
- [SR08] A. Slingsby and J. Raper. Navigable space in 3D city models for pedestrians. In *Advances in 3D geoinformation systems*, pages 49–64. Springer, 2008.
- [SR09] M. Swobodzinski and M. Raubal. An indoor routing algorithm for the blind: development and comparison to a routing algorithm for the sighted. *International Journal of Geographical Information Science*, 23(10):1315–1343, 2009.
- [SS09] A. Stepanov and J.M. Smith. Multi-objective evacuation routing in transportation networks. *European Journal of Operational Research*, 198(2):435–446, 2009.
- [SSO08] E.P. Stoffel, K. Schoder, and H.J. Ohlbach. Applying hierarchical graphs to pedestrian indoor navigation. In *Proceedings of the 16th ACM SIGSPATIAL International Conference on Advances in Geographic Information Systems*, GIS '08, pages 54:1–54:4, New York, NY, USA, 2008. ACM. doi=<http://doi.acm.org/10.1145/1463434.1463499>.
- [Ste94] A. Stentz. Optimal and efficient path planning for partially-known environments. In *Robotics and Automation, 1994. Proceedings., 1994 IEEE International Conference on*, pages 3310–3317. IEEE, 1994.
- [Ste95] A. Stentz. The focussed D* algorithm for real-time replanning. In *International Joint Conference on Artificial Intelligence*, volume 95, pages 1652–1659, 1995.
- [Sto12] J. Stook. Planning an indoor navigation service for a smartphone with wi-fi fingerprinting localization. Master's thesis, OTB Research Institute for the Built Environment, Delft University of Technology, Netherlands, 2012.
- [SW75] A.W. Siegel and S.H. White. The development of spatial representations of large-scale environments. *Advances in child development and behavior*, 10:9–55, 1975.
- [Sys16a] Bentley Systems. Design modeling software, 2016. online <https://www.bentley.com/en/products/product-line/modeling-and-visualization-software/microstation>.
- [Sys16b] Bentley Systems. i-model software development kit, 2016. online <https://www.bentley.com/en/software-developers/sharing-deliverables/i-model-sdk>.

- [Sys16c] Bentley Systems. i-models: Access and share information-rich models, 2016. online <https://www.bentley.com/en/i-models>.
- [SZVO11] J. Schaap, S. Zlatanova, and P. Van Oosterom. Towards a 3D geo-data model to support pedestrian routing in multimodal public transport travel advices. *Urban and Regional Data Management, UDMS Annual*, pages 63–78, 2011.
- [TAK⁺05] V. Tsetos, C. Anagnostopoulos, P. Kikiras, P. Hasiotis, and S. Hadjiefthymiades. A human-centered semantic navigation system for indoor environments. In *ICPS'05. Proceedings. International Conference on Pervasive Services, 2005.*, pages 146–155. IEEE, 2005.
- [TAKH06] V. Tsetos, C. Anagnostopoulos, P. Kikiras, and S. Hadjiefthymiades. Semantically enriched navigation for indoor environments. *International Journal of Web and Grid Services*, 2(4):453–478, December 2006. doi=<http://dx.doi.org/10.1504/IJWGS.2006.011714>.
- [TBF05] S. Thrun, W. Burgard, and D. Fox. *Probabilistic robotics*. MIT Press, 2005.
- [TC16] T.A. Teo and K.H. Cho. BIM-oriented indoor network model for indoor and outdoor combined route planning. *Advanced Engineering Informatics*, 30(3):268–282, 2016.
- [TG83] P.W. Thorndyke and S.E. Goldin. Spatial learning and reasoning skill. In *Spatial orientation*, pages 195–217. Springer, 1983.
- [THR82] P.W. Thorndyke and B. Hayes-Roth. Differences in spatial knowledge acquired from maps and navigation. *Cognitive psychology*, 14(4):560–589, 1982.
- [TMM⁺16] J. Torressospedra, R. Montoliu, G.M. Mendozasilva, O. Belmonte, D. Rambla, and J. Huerta. Providing databases for different indoor positioning technologies: Pros and cons of magnetic field and wi-fi based positioning. *Mobile Information Systems*, 2016:1–22, 2016.
- [Tou83] G.T. Toussaint. Solving geometric problems with the rotating calipers. In *Proc. IEEE MELECON 83*, pages 10–02, 1983.
- [VBWVHV093] J. Van Bemmelen, Quak W., M. Van Hekken, and P. Van Oosterom. Vector vs. raster-based algorithms for cross country movement planning. In *Proceedings AutoCarto 11*, page 304–317, 1993.
- [vdHZVV16] M.F.S. van der Ham, S. Zlatanova, E. Verbree, and R. Voûte. Real time localization of assets in hospitals using QUUPPA indoor positioning technology. *ISPRS Annals of Photogrammetry, Remote Sensing and Spatial Information Sciences*, IV-4/W1:105–110, 2016.
- [VDMF09] A. Vanclooster, P. De Maeyer, and V. Fack. Implementation of indoor navigation networks using CityGML. In *International Workshop on 3D Geo-Information*, pages 233–240, 2009.
- [Vis09] I. Visser. Route determination in disaster areas. Master's thesis, MSc thesis, Utrecht University, 2009.
- [VTCG11] W. Van Toll, A.F. Cook, and R. Geraerts. Navigation meshes for realistic multi-layered environments. In *2011 IEEE/RSJ International Conference on Intelligent Robots and Systems*, pages 3526–3532. IEEE, 2011.
- [VZVW⁺13] E. Verbree, S. Zlatanova, K. Van Winden, E.B. Van der Laan, A. Makri, T. Li, and H. Ai. To localise or to be localised with WiFi in the Hubei museum? In *Acquisition and Modelling of Indoor and Enclosed Environments 2013, Cape Town, South Africa, 11-13 December 2013, ISPRS Archives Volume XL-4/W4, 2013*, pages p.31–35. ISPRS, 2013.
- [Wal04] J.O. Wallgrün. Autonomous construction of hierarchical Voronoi-based route graph representations. In *International Conference on Spatial Cognition*, pages 413–433. Springer, 2004.
- [Whi32] H. Whitney. Non-separable and planar graphs. *Transactions of the American Mathematical Society*, 34:339–362, 1932.
- [Whi06] E. Whiting. Geometric, topological and semantic analysis of multi-building floor plan data. Master's thesis, 1 2006.

- [Wik16] Wikipedia. Industry foundation classes, 2016.
- [WMY07] H. Wu, A. Marshall, and W. Yu. Path planning and following algorithms in an indoor navigation model for visually impaired. In *Internet Monitoring and Protection, 2007. ICIMP 2007. Second International Conference on*, pages 38–38. IEEE, 2007.
- [Wor11] M. Worboys. Modeling indoor space. In *Proceedings of the 3rd ACM SIGSPATIAL International Workshop on Indoor Spatial Awareness, ISA '11*, pages 1–6, New York, NY, USA, 2011. ACM. doi=<http://doi.acm.org/10.1145/2077357.2077358>.
- [Wu15] H. Wu. Integration of 2D architectural floor plans into indoor openstreetmap for reconstructing 3D building models. Master's thesis, Delft University of Technology, 2015.
- [XA]C08] J. Xia, C. Arrowsmith, M. Jackson, and W. Cartwright. The wayfinding process relationships between decision-making and landmark utility. *Tourism Management*, 29(3):445–457, 2008.
- [Xu14] W. Xu. Spatial model-aided indoor tracking. Master's thesis, Delft University of Technology, 2014.
- [XWZ16] M. Xu, S. Wej, and S. Zlatanova. An indoor navigation approach considering obstacles and space subdivision of 2D plan. In *ISPRS - International Archives of the Photogrammetry, Remote Sensing and Spatial Information Sciences*, volume XLI-B4, pages 339–346, 2016.
- [XZZ⁺15] Q. Xiong, Q. Zhu, S. Zlatanova, Z. Du, Y. Zhang, and L. Zeng. Multi-level indoor path planning method. *ISPRS - International Archives of the Photogrammetry, Remote Sensing and Spatial Information Sciences*, XL-4/W5:p.19–23, 2015. doi=10.5194/isprsarchives-XL-4-W5-19-2015.
- [YCDN07] J. Ye, L. Coyle, S. Dobson, and P. Nixon. A unified semantics space model. In J. High-tower, B. Schiele, and T. Strang, editors, *Location- and Context-Awareness*, volume 4718 of *Lecture Notes in Computer Science*, pages 103–120. Springer Berlin Heidelberg, 2007. doi=http://dx.doi.org/10.1007/978-3-540-75160-1_7.
- [YS11] W. Yuan and M. Schneider. 3D indoor route planning for arbitrary-shape objects. In J. Xu, G. Yu, S. Zhou, and R. Unland, editors, *Database Systems for Advanced Applications*, volume 6637 of *Lecture Notes in Computer Science*, pages 120–131. Springer Berlin Heidelberg, 2011.
- [YW11] L. Yang and M. Worboys. A navigation ontology for outdoor-indoor space: (work-in-progress). In *Proceedings of the 3rd ACM SIGSPATIAL International Workshop on Indoor Spatial Awareness, ISA '11*, pages 31–34, New York, NY, USA, 2011. ACM.
- [ZB08] S. Zlatanova and S.S.K. Baharin. Optimal navigation of first responders using dbms. In *3rd international conference on information systems for crisis response and management 4th international symposium on geoInformation for disaster management*, pages 541–54. Citeseer, 2008.
- [Zha13] J. Zhao. The validation and repair of CityGML models (unpublished), 2013. On-line http://wiki.tudelft.nl/pub/Organisation/OTB/GIS/LunchMeetings/2013-12-06_The_Validation_and_Repair_of_CityGML_Models.pptx.
- [ZLS13] S. Zlatanova, L. Liu, and G. Sithole. A conceptual framework of space subdivision for indoor navigation. In *ACM Sigspatial International Workshop on Indoor Spatial Awareness*, pages 37–41, 2013.
- [ZLS⁺14] S. Zlatanova, L. Liu, G. Sithole, J. Zhao, and F. Mortari. Space subdivision for indoor applications, 2014. GIST Report No. 66, Delft University of Technology.
- [ZV04] S. Zlatanova and E. Verbree. User tracking as an alternative positioning technique for lbs. In *Proceedings of the Symposium on Location Based Services & Telecartography, Vienna, Austria, 28-29 January, 2004*, pages p.109–115, 2004.
- [ZZW⁺16] Y. Zhou, S. Zlatanova, Z. Wang, Y. Zhang, and L. Liu. Moving human path tracking based on video surveillance in 3D indoor scenarios. *ISPRS Annals of Photogrammetry, Remote Sensing and Spatial Information Sciences*, III-4:p.97–101, 2016.

Appendix - Proof of three lemmas in Chapter 5

As mentioned in Subsection 5.2, the *final convex hull (FCH)* contains all the selected obstacles from the start and target locations (e.g., doors). Here I present FCH-related lemmas and proof. The illustration adopted irregular polygons to represent indoor static obstacles (polygons).

Lemma 1. If a polygon contains some static indoor obstacles, then the polygon also contains all the visibility edges of the VG derived with these obstacles.

Proof. Supposing one of the visibility edges intersects or lies outside the polygon, then there must be (at least) one obstacle vertex outside of the polygon. Because the polygon contains all the selected obstacles, it naturally contains all the obstacle vertices. Thus, the inference of the outside vertex conflicts with this fact, which implies the polygon contains all the visibility edges of these obstacles.

Conversely, if a polygon contains all the visibility edges of the obstacles inside of it, then the polygon contains all the obstacle vertices. Therefore, these obstacles are included in the polygon as well. Therefore, *Lemma 1* is proved.

Certainly, the polygon can be a *convex hull (CH)* of these obstacles and the start and target.

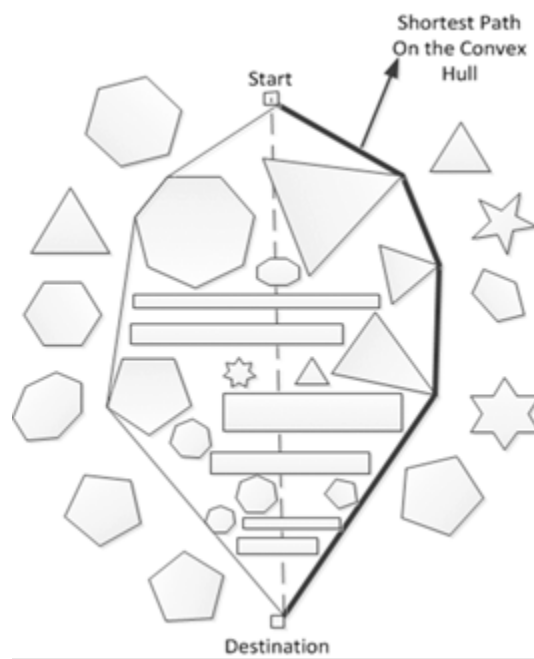

FIGURE A.1 The shortest path in the bound of a FCH.

Lemma 2. Given a user size, related grouped obstacles, and the start and target in a space, if a computed FCH does not intersect exterior obstacles, then the shortest path from the start to the target is either inside or in the bound of the FCH.

Proof. The FCH does not intersect exterior obstacles (see selecting obstacle groups with FCH in Subsection 5.2), which indicates there are accessible gaps in between the FCH and exterior obstacles. According to Lemma 1, the FCH contains all the visibility edges of the contained obstacles. As the FCH is computed from all the contained obstacle vertices, segments of the FCH are also visibility edges among these obstacles. The shortest path can be computed on the VG consisting of these visibility edges. Thus, the shortest path is either inside or in the bound of the FCH (Figure A.1) and never outside the FCH. Then Lemma 2 is proved.

According to Lemma 2, the shortest path is either contained in the computed FCH or in the bound of the FCH. However, it is not clear whether the path is equal to the shortest path generated from the VG derived with all obstacles in the same space. The following Lemma 3 proves that the two types of shortest path are the same.

Lemma 3. Given a user size, related grouped obstacles, and the start and target in a space, the real shortest path from the start to target is the shortest path derived in the VG of obstacles in the FCH.

Before the proof, I first introduce two notations. The shortest path computed with the VG of obstacles in the FCH is named $P1$, and the global shortest path computed with all the obstacles in the space is named $P2$. $P2$ is the real shortest path. My purpose is to prove $P1$ is equal to $P2$.

Proof. $P2$ has three possible forms: to be completely outside the FCH, completely inside the FCH (including in the FCH bound) or partially inside the FCH. Firstly, if $P2$ is completely inside the FCH, then Lemma 3 is self-proved.

Secondly, suppose $P2$ is completely outside of the FCH, which is shown in Figure A.2. Figure A.2 presents a FCH between the start and destination, and $P2$ is an exterior path to the FCH. I add several auxiliary lines between the FCH and $P2$, namely, $M_1N_1, M_2N_2, \dots, M_tN_t$ ($t > 0$). Because the FCH is a convex polygon, the auxiliary lines of the FCH's edges would never enter into the FCH's interior.

Since the shortest way between two points is a straight line, in Figure 7 I readily have

$$SM_1 + M_1N_1 < S\dots N_1 \quad (8.1)$$

where $S\dots N_1$ denotes the length of all the segments from S to N_1 along $P2$. Analogously, I have

$$M_1M_2 + M_2N_2 < M_1N_1 + N_1\dots N_2 \quad (8.2)$$

$$M_2M_t + M_tN_t < M_2N_2 + N_2\dots N_t \quad (8.3)$$

$$M_t D < M_t N_t + N_t \dots D \quad (8.4)$$

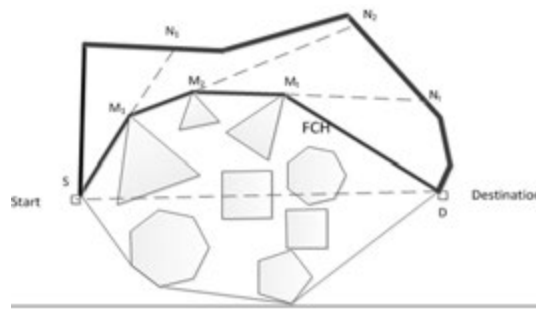

FIGURE A.2 The assumption that $P2$ lies completely outside of the FCH .

Combining the inequalities (1), (2), (3) and (4), a new inequality is as follows:

$$SM_1 + M_1 M_2 + M_2 M_t + M_t D < S \dots N_1 + N_1 \dots N_2 + N_2 \dots N_t + N_t \dots D \quad (8.5)$$

Equally, there is,

$$SM_1 + M_1 M_2 + M_2 M_t + M_t D < \text{length}(P2) \quad (8.6)$$

Inequality (6) indicates that the path from S to D along the FCH (denoted by SD) is shorter than $P2$. As I denote the shortest path inside of the FCH (or in the FCH bound) as $P1$, thus there is:

$$\text{Length}(P1) \leq SD < \text{length}(P2) \quad (8.7)$$

If $P1$ is contained in the FCH , then $P1$ is shorter than the path SD along the FCH ; if the 'shortest' path inside the FCH is longer than SD , then $P1$ is just SD (Figure A.1). In either case $P2$ is always longer than $P1$, which contradicts the condition ' $P2$ is the real shortest path'. Therefore, $P2$ cannot be completely outside of the FCH .

Thirdly, suppose $P2$ lies partially inside of the FCH . In Figure A.3, without loss of generality, suppose $P2$ is equal to

$$S \dots M_1 + M_1 \dots M_2 + M_2 \dots D$$

, which is represented by the dashed lines. I denote the exterior part of $P2$ by $M_1 \dots M_2$ (dashed lines) and the straight line between M_1 and M_2 by $M_1 M_2$. Apparently, $M_1 M_2 < M_1 \dots M_2$. Thus a path in the FCH , which is denoted by

$$S \dots M_1, M_1 M_2$$

and $M_2...D$, is shorter than P_2 . Again, this result contradicts ' P_2 is the real shortest path'. Therefore, P_2 cannot be partially inside of the FCH.

Finally, I can conclude the only possibility is P_2 lies inside the FCH or in the FCH bound. Then Lemma 3 is proved.

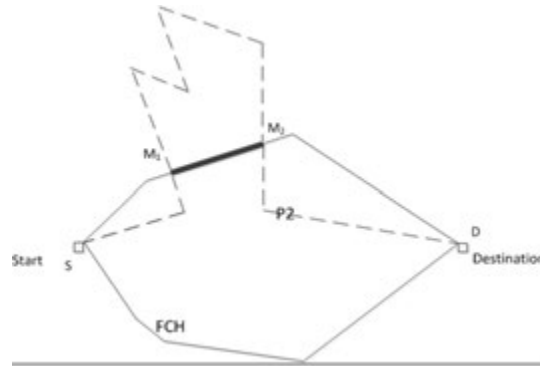

FIGURE A.3 P_2 lies partially inside of the FCH. P_2 is denoted by dashed lines.

Summary

Humans perform many activities indoors and they show a growing need for indoor navigation, especially in unfamiliar buildings such as airports, museums and hospitals. Complexity of such buildings poses many challenges for building managers and visitors. Indoor navigation services play an important role in supporting these indoor activities. Indoor navigation covers extensive topics such as: 1) indoor positioning and localization; 2) indoor space representation for navigation model generation; 3) indoor routing computation; 4) human wayfinding behaviours; and 5) indoor guidance (e.g., textual directories). So far, a large number of studies of pedestrian indoor navigation have presented diverse navigation models and routing algorithms/methods. However, the major challenge is rarely referred to: how to represent the complex indoor environment for pedestrians and conduct routing according to the different roles and sizes of users. Such complex buildings contain irregular shapes, large open spaces, complicated obstacles and different types of passages. A navigation model can be very complicated if the indoors are accurately represented. Although most research demonstrates feasible indoor navigation models and related routing methods in regular buildings, the focus is still on a general navigation model for pedestrians who are simplified as circles. In fact, pedestrians represent different sizes, motion abilities and preferences (e.g., described in user profiles), which should be reflected in navigation models and be considered for indoor routing (e.g., relevant Spaces of Interest and Points of Interest).

In order to address this challenge, this thesis proposes an innovative indoor modelling and routing approach – *two-level routing*. It specially targets the case of routing in complex buildings for distinct users. The conceptual (first) level uses general free indoor spaces: this is represented by the *logical* network whose nodes represent the spaces and edges stand for their connectivity; the detailed (second) level focuses on transition spaces such as openings and *Spaces of Interest (SOI)*, and *geometric* networks are generated regarding these spaces. Nodes of a geometric network refers to locations of doors, windows and subspaces (SOIs) inside of the larger spaces; and the edges represent detailed paths among these geometric nodes. A combination of the two levels can represent complex buildings in specified spaces, which avoids maintaining a large-scale complete network. User preferences on ordered SOIs are considered in routing on the logical network, and preferences on ordered *Points of Interest (POI)* are adopted in routing on geometric networks. In a geometric network, accessible obstacle-avoiding paths can be computed for users with different sizes.

To facilitate automatic generation of the two types of network in any building, a new data model named *Indoor Navigation Space Model (INSM)* is proposed to store connectivity, semantics and geometry of indoor spaces for buildings. Abundant semantics of building components are designed in *INSM* based on navigational functionalities, such as *VerticalUnit(VU)* and *HorizontalConnector(HC)* as vertical and horizontal passages for pedestrians. The *INSM* supports different subdivision ways of a building in which indoor spaces can be assigned proper semantics.

A *logical* and *geometric* network can be automatically derived from *INSM*, and they can be used individually or together for indoor routing. Thus, different routing options are designed. Paths can be provided by using either the logical network when some users

are satisfied with a rough description of the path (e.g., the name of spaces), or a geometric path is automatically computed for a user who needs only a detailed path which shows how obstacles can be avoided. The two-level routing approach integrates both logical and geometric networks to obtain paths, when a user provides her/his preferences on SOIs and POIs. For example, routing results for the logical network can exclude unrelated spaces and then derive geometric paths more efficiently. In this thesis, two options are proposed for routing just on the logical network, three options are proposed for routing just on the geometric networks, and seven options for two-level routing.

On the logical network, six routing criteria are proposed and three human wayfinding strategies are adopted to simulate human indoor behaviours. According to a specific criterion, space semantics of logical nodes is utilized to assign different weights to logical nodes and edges. Therefore, routing on the logical network can be accomplished by applying the *Dijkstra* algorithm. If multiple criteria are adopted, an order of criteria is applied for routing according to a specific user. In this way, logical paths can be computed as a sequence of indoor spaces with clear semantics.

On geometric networks, this thesis proposes a new routing method to provide detailed paths avoiding indoor obstacles with respect to pedestrian sizes. This method allows geometric networks to be derived for individual users with different sizes for any specified spaces.

To demonstrate the use of the two types of network, this thesis tests routing on one level (the logical or the geometric network). Four case studies about the logical network are presented in both simple and complex buildings. In the simple building, no multiple paths lie between spaces A and B, but in the complex buildings, multiple logical paths exist and the candidate paths can be reduced by applying these routing criteria in an order for a user. The relationships of these criteria to user profiles are assumed in this thesis.

The proposed geometric routing regarding user sizes is tested with three case studies: 1) routing for pedestrians with two distinct sizes in one space; 2) routing for pedestrians with changed sizes in one space; and 3) a larger geometric network formed by the ones in a given sequence of spaces. The first case shows that a small increase of user size can largely change the accessible path; the second case shows different path segments for distinct sizes can be combined into one geometric path; the third case demonstrates a geometric network can be created 'on the fly' for any specified spaces of a building. Therefore, the generation and routing of geometric networks are very flexible and fit to given users.

To demonstrate the proposed two-level routing approach, this thesis designs five cases. The five cases are distinguished according to the method of model creation (pre-computed or 'on-the-fly') and model storage (on the client or server). Two of them are realized in this thesis: 1) Case 1 just in the client pre-computes the logical network and derives geometric networks 'on the fly'; 2) Case 2 just in the client pre-computes and stores the logical and geometric networks for certain user sizes. Case 1 is implemented in a desktop application for building managers, and Case 2 is realized as a mobile mock-up for mobile users without an internet connection.

As this thesis shows, two-level routing is powerful enough to effectively provide indicative logical paths and/or comprehensive geometric paths, according to different user requirements on path details. In the desktop application, three of the proposed routing options for two-level routing are tested for the simple *OTB* building and the complex *Schiphol Airport* building. These use cases demonstrate that the two-level routing approach includes the following merits:

- It supports routing in different abstraction forms of a building. The INSM model can describe different subdivision results of a building, and it allows two types of routing network to be derived – pure logical and geometric ones. The logical network contains the topology and semantics of indoor spaces, and the geometric network provides accurate geometry for paths. A consistent navigation model is formed with the two networks, *i.e.*, the conceptual and detailed levels.
- On the conceptual level, it supports routing on a logical network and assists the derivation of a conceptual path (*i.e.*, logical path) for a user in terms of space sequence. Routing criteria are designed based on the INSM semantics of spaces, which can generate logical paths similar to human wayfinding results such as minimizing VerticalUnit or HorizontalConnector.
- On the detailed level, it considers the size of users and results in obstacle-avoiding paths. By using this approach, geometric networks can be generated to avoid obstacles for the given users and accessible paths are flexibly provided for user demands. This approach can process changes of user size more efficiently, in contrast to routing on a complete geometric network.
- It supports routing on both the logical and the geometric networks, which can generate geometric paths based on user-specific logical paths, or re-compute logical paths when geometric paths are inaccessible. This computation method is very useful for complex buildings. The two-level routing approach can flexibly provide logical and geometric paths according to user preferences and sizes, and can adjust the generated paths in limited time.

Based on the two-level routing approach, this thesis also provides a vision on possible cooperation with other methods. A potential direction is to design more routing options according to other indoor scenarios and user preferences. Extensions of the two-level routing approach, such as other types of semantics, multi-level networks and dynamic obstacles, will make it possible to deal with other routing cases. Last but not least, it is also promising to explore its relationships with indoor guidance, different building subdivisions and outdoor navigation.

Samenvatting

Mensen verrichten veel activiteiten binnenin gebouwen en hebben een toenemende behoefte aan indoornavigatie, voornamelijk in onbekende gebouwen zoals luchthavens, musea en ziekenhuizen. De complexiteit van dergelijke gebouwen leidt tot veel uitdagingen voor gebouwbeheerders en bezoekers. Indoornavigatieservices spelen een belangrijke rol bij het ondersteunen van deze indooractiviteiten. Indoornavigatie dekt veel omvangrijke thema's af, zoals: 1) indoorplaatsbepaling en -lokalisatie; 2) modelering indoorruimte ten behoeve van navigatie; 3) berekening van de indoorroute; 4) menselijk gedrag t.a.v. oriëntatie en navigatie en indoorbegeleiding (bijv. tekstinformatie). Tot nu presenteerde een groot aantal onderzoeken naar indoornavigatie voor voetgangers verschillende navigatiemodellen en routealgoritmen/methoden. Echter aan de allerbelangrijkste uitdaging wordt zelden gerefereerd: hoe de complexe indooromgeving voor voetgangers te representeren en routeplanning uit te voeren op basis van de diverse rollen en de verschillende omvang van gebruikers de weg te wijzen. Dergelijke complexen bestaan uit onregelmatige vormen, grote open ruimten, gecompliceerde obstakels en diverse soorten doorgangen. Een navigatiemodel kan zeer ingewikkeld zijn als de omgeving nauwkeurig gerepresenteerd wordt. Alhoewel het meeste onderzoek aantoont dat haalbare indoornavigatiemodellen en gerelateerde routeplanningsmethoden in normale (reguliere) gebouwen werken, ligt de nadruk nog steeds op een algemeen navigatiemodel voor voetgangers dat gesimplificeerd wordt weergegeven als een cirkel. Echter cruciaal zijn het representeren van voetgangers met verschillende omvang, bewegingsmogelijkheden en voorkeuren (zoals bijv. beschreven in gebruikersprofielen). Dit zou tot uitdrukking gebracht moeten worden in de navigatiemodellen en hiermee zou rekening gehouden moeten worden bij indoorrouteplanning (bijv. relevante '*Space of Interest*' en '*Point of Interest*').

Om deze uitdaging aan te gaan wordt in deze dissertatie een innovatieve aanpak van indoormodellering en routeplanning voorgesteld, te weten routeplanning op twee niveaus. Het richt zich met name op de routeplanning in complexe gebouwen ten behoeve van verschillende gebruikers. Het conceptuele (eerste) niveau maakt gebruik van algemene vrije indoorruimten: het wordt gerepresenteerd door het logisch netwerk waarvan de *nodes* (knooppunten) de ruimten representeren en de *edges* (verbindingen) hun connectiviteit aangeven. Het gedetailleerde (tweede) niveau richt zich op transitieruimten, zoals doorgangen en *Space of Interest (SOI)*. Geometrische netwerken worden gegenereerd voor deze verzameling van ruimten. *Nodes* van een geometrisch netwerk verwijzen naar de plaats waar zich deuren, ramen en subruimten (SOIs) in de grotere ruimten bevinden. De *edges* representeren gedetailleerde verbindingen langs deze geometrische *nodes*. Een combinatie van de twee niveaus kan complexe gebouwen representeren waardoor het onderhouden van een omvangrijk netwerk kan worden vermeden. Gebruikersvoorkeuren voor aangevraagde SOIs worden in de routeplanning van het logisch netwerk meegenomen. Voorkeuren voor aangevraagde *Points of Interest (POIs)* in routeplanning worden in geometrische netwerken opgenomen. In een geometrisch netwerk kunnen toegankelijke obstakel-vermijdende verbindingen voor gebruikers van verschillende omvang worden berekend.

Om de automatische generatie van de twee netwerktypen in welk gebouw dan ook te faciliteren wordt een nieuw datamodel - het *Indoor Navigation Space Model (INSM)* - voorgesteld om connectiviteit, semantiek en geometrie van indoorruimten voor gebouwen

op te slaan. Volledige semantiek van gebouwcomponenten wordt ontworpen in het *INSM* gebaseerd op navegeerbare eenheden, zoals *VerticalUnit(VU)* en *HorizontalConnector(HC)* als verticale en horizontale doorgangen voor voetgangers. Het *INSM* ondersteunt verschillende opdelingen van een gebouw waarbij indoorkuizen aan de juiste semantiek worden gekoppeld.

Een *logisch* en *geometrisch* netwerk kan automatisch worden afgeleid van het *INSM*. Deze kunnen onafhankelijk van elkaar of gezamenlijk voor indoorrouteplanning worden gebruikt. Er zijn dus verschillende opties voor routeplanning ontworpen. Als gebruikers genoeg nemen met een ruwe beschrijving van de route (bijv. de naam van ruimten) kunnen de routes worden weergegeven door gebruik van het logisch netwerk. Een geometrische route wordt automatisch berekend voor een gebruiker die een gedetailleerde route, waarin wordt aangegeven hoe obstakels kunnen worden vermeden, nodig heeft. Als een gebruiker zijn/haar voorkeuren voor SOIs en POIs opgeeft integreert de routeplanning op twee niveaus zowel het logisch als het geometrisch netwerk om routes te genereren. Zo kunnen routeplanningsresultaten in het logisch netwerk ruimten die er niet toe doen uitsluiten en vervolgens geometrische routes meer efficiënt afleiden. In deze dissertatie worden voor routeplanning twee opties in alleen het logisch netwerk, drie opties in het geometrisch netwerk en zeven opties op twee niveaus voorgesteld.

Voor het logisch netwerk worden zes routebepalingscriteria aangegeven en drie menselijke oriëntatie- en navigatiestrategieën geadopteerd om het menselijk gedrag te simuleren. Op basis van een specifiek criterium wordt ruimtesemantiek van logische *nodes* gebruikt om verschillende gewichten aan logische *nodes* en *edges* toe te kennen. Door het toepassen van het Dijkstra algoritme kan routeplanning in het logisch netwerk worden gerealiseerd. Als meervoudige criteria worden geadopteerd wordt een volgorde van criteria voor routeplanning passend bij een specifieke gebruiker doorgevoerd. Op deze manier kunnen logische routes in een opeenvolging van de indoorkuizen met een heldere semantiek worden berekend.

Voor geometrische netwerken wordt in dit proefschrift een nieuwe routeplanningsmethode voorgesteld om gedetailleerde routes met indoorobstakels voor voetgangers met een verschillende omvang te identificeren. Deze methode maakt het mogelijk geometrische netwerken voor individuele gebruikers met een verschillende omvang voor elke gespecificeerde ruimte af te leiden.

Om het gebruik van de twee typen netwerken te illustreren wordt in dit proefschrift de routeplanning eerst op één niveau (het logisch of het geometrisch netwerk) getest. Vier casestudies inzake het logisch netwerk voor zowel eenvoudige als complexe gebouwen worden gepresenteerd. In eenvoudige gebouwen liggen geen meervoudige paden omvang tussen ruimte A en B. In complexe gebouwen bestaan meerdere logische routes en de kandidaat routes kunnen worden verminderd door het toepassen van deze routeplanningscriteria in volgorde van prioriteit voor een gebruiker). In deze dissertatie wordt van de relaties van deze criteria met de gebruikersprofielen uitgegaan.

De voorgestelde geometrisch routeplanning met betrekking tot de omvang van de gebruikers is in drie casestudies getest: 1) routeplanning voor twee voetgangers van verschillende omvang in één ruimte; 2) routeplanning voor een voetganger van veranderende omvang in één ruimte; 3) een groter geometrisch netwerk dat gevormd wordt voor koppeling van een opeenvolgende serie van ruimten. De eerste casus toont

aan, dat een kleine toename van de omvang van de gebruikers een grote verandering van de route kan opleveren; de tweede casus heeft verschillende routesegmenten voor onderscheiden omvang waarmee een combinatie in één geometrische route mogelijk wordt gemaakt; de derde casus geeft een geometrisch netwerk dat *on the fly* voor iedere gespecificeerde ruimte van een gebouw beschikbaar is. Hierdoor worden de generatie en routeplanning van geometrische netwerken zeer flexibel en toepasbaar voor de gebruikers.

Om de voorgestelde routeplanning op twee niveaus te illustreren worden er vijf cases in deze dissertatie geïntroduceerd. Deze vijf cases worden conform de modelcreatie (vooraf berekend of *on the fly*) en modelopslag (in de client of de server) onderscheiden. Twee hiervan worden in deze dissertatie gerealiseerd: 1) In casus 1 wordt in de client alleen het logisch netwerk vooraf berekend en worden geometrische netwerken *on the fly* afgeleid; 2) In casus 2 worden alleen in de client de routes vooraf berekend en opgeslagen in het logisch en geometrisch netwerk voor gebruikers van een bepaalde omvang. Casus 1 is op een desktopapplicatie voor gebouwbeheerders geïmplementeerd en casus 2 is als een mobiele *mock-up* voor mobiele gebruikers zonder internetverbinding gerealiseerd.

Zoals in deze dissertatie aangetoond is de routeplanning op twee niveaus krachtig genoeg om ruwe logische routen en/of gedetailleerde geometrische routes conform de verschillende gebruikerseisen effectief aan te bieden. In de desktopapplicatie zijn drie van de voorgestelde opties voor routeplanning op twee niveaus getest voor het eenvoudige gebouw van het *OTB* en het complexe gebouw van de luchthaven *Schiphol*. Deze gebruikscases tonen aan dat de aanpak van de routeplanning op twee niveaus de volgende voordelen oplevert:

- Het ondersteunt routeplanning in verschillende abstractievormen van een gebouw. Het INSM model kan meerdere opdelingen van een gebouw omschrijven. Twee typen van een routeplanningsnetwerk - logische en geometrische - kunnen worden afgeleid. Het logisch netwerk bevat topologie en semantiek van indoorruimten en het geometrisch levert accurate geometrie voor routes. Een consistent navigatiemodel wordt gevormd door de twee netwerken te combineren.
- Op het conceptuele niveau wordt routeplanning in een logisch netwerk ondersteund. Het assisteert het afleiden van een conceptueel route (i.c. logische route) voor een gebruiker als serie opeenvolgende ruimten. Gebaseerd op de INSM semantiek van ruimten, waarmee logische ruimten gelijk aan menselijke oriëntatie- en navigatieresultaten genereerd kunnen worden (zoals het minimaliseren van gebruik *VerticalUnit* of *HorizontalConnector*) zijn routeplanningscriteria ontworpen.
- Op het gedetailleerde niveau wordt de omvang van gebruikers meegenomen, dat resulteert in het vermijden van obstakels op de routes. Door van deze aanpak gebruik te maken kunnen geometrische netwerken worden gegeneerd om obstakels voor de gebruikers te omzeilen. Toegankelijke routes worden flexibel op gebruikersverzoek aangegeven. Deze benadering kan de wijzigingen van de omvang van gebruikers efficiënter verwerken. Dit in tegenstelling tot routeplanning via een compleet geometrisch netwerk.
- Het ondersteunt routeplanning zowel in het logisch als in geometrisch netwerk. Hiermee kunnen geometrische routes gebaseerd op gebruikers specifieke logische routes

worden gegenereerd of kunnen logische routes als geometrische routes niet beschikbaar zijn opnieuw worden berekend. Deze berekeningswijze is erg nuttig voor complexe gebouwen. De routeplanning op twee niveaus heeft de mogelijkheid om flexibel logische en geometrische paden conform gebruikersvoorkeuren en omvang aan te bieden en kan de gegenereerde paden in korte tijd aanpassen.

Op basis van de routeplanning op twee niveaus wordt in deze dissertatie ook een visie gegeven voor mogelijke integratie met andere methoden. Een potentiële richting is het ontwerpen van meer routingplanningsopties conform andere indoorscenarios en gebruikersvoorkeuren. Uitbreiding van de routeplanning op twee niveaus, zoals andere semantiektypen, meerlaagse netwerken en dynamische obstakels, zal het mogelijk maken om met andere routeplanningscases te integreren. Tenslotte is het zeker de moeite de waard de relaties met indoorbegeleiding, verschillende opdelingen van gebouwen en outdoornavigatie verder te onderzoeken.

Curriculum Vitae

Liu Liu was born in Kaiyang, China, on January 11, 1986. He graduated with a BSc in Surveying Engineering at the Tongji University in Shanghai in 2007. He then did his MSc in Geographic Information System at the Beijing Normal University in Beijing, and graduated in 2010. Afterwards Liu joined the GIST section of the OTB Research Institute in Delft and started his PhD project Semantic Modelling for Indoor Routing, funded by the China Scholarship Council (CSC), and supervised by Peter Van Oosterom and Sisi Zlatanova. In October 2014, Liu visited Bentley System Inc. headquartered in Exton, USA, and collaborated with Mark Anderson and Mark Smith on an indoor navigation project through 2015. The work of this project later became a part of Chapter 7 of this thesis.

Liu enjoys working on indoor navigation studies and spatial analysis problems. Now he is continuing the research of modelling, navigation and spatial analysis of indoor environments.

